

**Tillbridge Solar Project
EN010142**

**Volume 7
Framework Construction Traffic Management Plan
Part 1 of 2
Document Reference: EN010142/APP/7.11**

**Regulation 5(2)(q)
Infrastructure Planning (Applications: Prescribed Forms and
Procedure) Regulations 2009**

**April 2024
Revision Number: 00**

Table of Contents

1.	Introduction	1
1.1	Scheme Description.....	1
1.2	Context	1
1.3	Document Purpose and Scope	2
1.4	Objectives	3
1.5	Report Structure	3
2.	Existing Conditions	5
3.	Future Highway Network.....	5
4.	Policy and Best Practice	5
5.	Construction Movements	5
5.1	Introduction	5
5.2	Construction Programme	5
5.3	Construction Vehicle Movements.....	6
	Principal Site	6
	Cable Route Corridor	9
5.4	Vehicle Types.....	12
5.5	Plant Requirements	12
5.6	Abnormal Vehicles	13
6.	Site Access, Layout and Routing	14
6.1	Introduction	14
	Site Access Arrangements	14
6.2	Access Layouts.....	17
6.3	Access Tracks.....	17
6.4	Vehicle Swept Path (non-AIL)	18
6.5	Vehicle Routing.....	18
6.6	Abnormal Indivisible Loads	19
6.7	Visibility Splays	19
6.8	Car and Cycle Parking	20
6.9	Construction Compounds	20
7.	Management and Measures	21
7.1	Introduction	21
7.2	Management Measures and Controls.....	21
	HGV Measures and Controls	21
	Staff Measures and Controls	26
7.3	Additional Measures and Controls	29
	Stage 1 Road Safety Audit.....	29
	Traffic Management Measures	29
	Highway Measures	30
7.4	PRoW	32
7.5	Combined Measures.....	33
7.6	Management Structure	34
7.7	Monitoring and Review	35
	HGVs	35

Staff	35
8. Compliance and Enforcement.....	36
8.1 Introduction	36
8.2 Compliance.....	36
8.3 Best Practice.....	36
8.4 Contractual Conditions	37
8.5 Information Packs and Communications.....	37
8.6 Enforcement	37
9. Conclusion.....	38
10. References	39
Appendix A Indicative Scheme Access Plans.....	40
Appendix B Figures	41
Appendix C Abnormal Indivisible Loads Management Plan	42

Tables

Table 5-1: Forecast Trip Distribution (Construction Accesses) for the Principal Site .	8
Table 5-2: Forecast Peak Daily Construction Vehicles for the Principal Site	8
Table 5-3: Forecast Peak Daily and Hourly Construction Vehicle Movements for the Principal Site	9
Table 5-4: Forecast Peak Daily and Hourly Construction Vehicle Movements for the Cable Route Corridor	10
Table 16-23 Potential Road Closures.....	31

1. Introduction

1.1 Scheme Description

- 1.1.1 The Tillbridge Solar Project (the Scheme) will comprise the construction, operation (including maintenance), and decommissioning of ground-mounted solar photovoltaic (PV) arrays. The Scheme will also include associated development to support the solar PV arrays.
- 1.1.2 The Scheme is made up of the Principal Site, the Cable Route Corridor and works to the existing National Grid Cottam Substation. The Principal Site comprises the solar PV arrays, electrical substations, grid balancing infrastructure, cabling and areas for landscaping and ecological enhancement.
- 1.1.3 The associated development element of the Scheme includes but is not limited to access provision; a Battery Energy Storage System (BESS), to support the operation of the ground mounted solar PV arrays; the development of on-site substations; underground cabling between the different areas of solar PV arrays; and areas of landscaping and biodiversity enhancement.
- 1.1.4 The Scheme also includes a 400kV underground Cable Route Corridor of approximately 18.5km in length connecting the Principal Site to the National Electricity Transmission System (NETS) at the existing National Grid Cottam Substation. The Scheme will export and import electricity to the NETS.
- 1.1.5 A full description of the Scheme is included in **Chapter 3: Scheme Description** of the Environmental Statement [EN010142/APP/6.1]. An overview of the Scheme and its environmental impacts is provided in the Environmental Statement Non-Technical Summary [EN010142/APP/6.4].

1.2 Context

- 1.2.1 AECOM has been appointed by Tillbridge Solar Ltd (hereafter referred to as 'the Applicant') to prepare a combined Framework Construction Traffic Management Plan (CTMP) and Travel Plan as part of the proposed Scheme, located approximately 5 km to the east of Gainsborough and approximately 13 km to the north of Lincoln in Lincolnshire. This Framework CTMP forms part of the Development Consent Order (DCO) submission.
- 1.2.2 The Scheme is split across two administrative areas, namely Lincolnshire County Council and Nottinghamshire County Council. The Scheme primarily consists of agricultural fields mainly under arable production, with some small parcels of pasture, interspersed with trees, hedgerows, small areas of woodland and farm access tracks.
- 1.2.3 The Scheme comprises the installation of PV panels and on-site energy storage facilities at the Site within Lincolnshire County Council (hereafter referred to as the 'Principal Site') and associated infrastructure for connection to the existing National Grid Cottam Substation, which is located at the decommissioned Cottam Power Station in Nottinghamshire County

Council (hereafter referred to as the 'Cable Route Corridor'). The Scheme would allow for the generation, storage, export and import of electricity with an anticipated capacity greater than 50 megawatts (MW).

- 1.2.4 The electricity generated by the Scheme will be exported to the National Grid via the Cable Route Corridor, through a connection between the Principal Site Substations and National Grid Cottam Substation. This connection will also facilitate the import of electricity to be stored within the BESS.

1.3 Document Purpose and Scope

- 1.3.1 This Framework CTMP supports **Chapter 16: Transport and Access** of the ES [EN010142/APP/6.1] which is submitted with the DCO Application to the Secretary of State for Energy Security and Net Zero. The **draft DCO [EN010142/APP/3.1]** includes a requirement for the Framework CTMP to be developed into a Detailed CTMP that would be submitted for the approval of the relevant authorities before construction begins. The DCO would, therefore, include a Requirement to secure compliance with the measures set out in the Detailed CTMP.
- 1.3.2 It should be noted that as this is a framework document, it sets out what the Applicant would consider is broadly required in order to manage the impact of construction traffic, however certain details remain to be developed as the design of the Scheme progresses. The full detail of all measures may not be available until after consent for the Scheme has been granted and so the Framework CTMP sets out the likely measures that will be implemented in accordance with the Requirements of the DCO, if granted. A Detailed CTMP or potentially a number of Detailed CTMPs will be required to be produced by the Applicant prior to commencement of construction of the Scheme, which would be secured as part of the DCO post-consent.
- 1.3.3 The Cable Route Corridor for the Scheme has the potential to be shared with three nearby solar Nationally Significant Infrastructure Projects (NSIPs), which are the West Burton Solar Project, Cottam Solar Project and Gate Burton Energy Park. For the purposes of transport and access, it is considered that a shared Cable Route Corridor would reduce potential cumulative effects. It is proposed that a Joint CTMP document is to be prepared between the Scheme and the other solar DCOs post-consent to manage and mitigate cumulative effects, once further details are known on project timeframes and the approach for the shared Cable Route Corridor. The potential sharing of the Cable Route Corridor would be expected to reduce cumulative effects as this would consolidate and reduce trips across the network compared to a situation where separate cable route corridors were taken forward. Alternatively, the sequential installation of ducts and cables would reduce any temporal overlap between the Scheme and the three other projects, further details related to the Cumulative effects related to transport and access are set out within Section 18.17 of **Chapter 18: Cumulative Effects and Interactions** of the ES [EN010142/APP/6.1]. In the interim, the measures set out in this Framework CTMP are based on the worst-case scenario assumption that the installation of the Cable Route Corridor is carried out independently of the other DCO solar projects. However, the Applicant continues to liaise with the other DCO solar projects to combine works and minimise cumulative effects where possible.

- 1.3.4 This document sets out the Applicant's proposals to manage construction traffic and staff vehicles within the vicinity of the Scheme along the local highway network during the construction period of the works, in order to limit any potential disruptions and implications on the wider transport network. It identifies the management of freight traffic i.e. Heavy Goods Vehicles (HGVs), as well as staff (construction worker) vehicles.
- 1.3.5 This Framework CTMP has been informed by consultation with Lincolnshire and Nottinghamshire County Council's as the Local Highway Authorities (LHAs). Further details of the discussions and meetings held, as well as meeting minutes etc. are provided as part of the Transport Assessment (TA) (**Appendix 16-2** of the ES [EN010142/APP/6.2]).
- 1.3.6 Within each section of this Framework CTMP, a summary is included on the purpose of the section and if it is expected to be updated in the Detailed CTMP.

1.4 Objectives

- 1.4.1 The objectives of this Framework CTMP are to set a framework for the measures that would be developed in the Detailed CTMP(s) to:
- a. Minimise the volume of HGV and staff vehicles associated with the construction phase as far as reasonably practicable;
 - b. Maximise the safe and efficient movement of materials and staff required during the construction phase as far as reasonably practicable;
 - c. Minimise the effect on, and ensure efficient management, of the local Public Rights of Way (PRoW) and Claimed PRoW within the Scheme Order limits during the construction phase;
 - d. Minimise the impacts both for the local community and visitors to the area using the road network as far as reasonably practicable; and
 - e. Set out the measures (i.e. management plan) to be adhered to by those travelling to and from the Scheme to reduce the impact of its construction on the local highway network and local communities.

1.5 Report Structure

- 1.5.1 This Framework CTMP is structured as follows:
- a. **Section 2** provides details of the existing conditions regarding the Scheme;
 - b. **Section 3** provides details of future baseline conditions during the construction phase;
 - c. **Section 4** covers relevant planning policy and best practice for the construction phase of the Scheme;
 - d. **Section 5** summarises the HGV and staff vehicle movements that are expected to be generated by the Scheme across the construction period, including during the peak phase;
 - e. **Section 6** provides details of the proposed Site accesses for the Principal Site and the Cable Route Corridor, including details of layouts,

visibility splays and swept paths, as well as routing arrangements and internal Site layout considerations including access tracks, compounds and parking;

- f. **Section 7** provides details of the proposed management and measures;
- g. **Section 8** outlines compliance and enforcement; and
- h. **Section 9** provides the conclusion to the document.

1.5.2 This document is supported by the following appendices:

- a. Appendix A – Indicative Scheme Access Plans; and
- b. Appendix B – Figures:
 - i. Figure 1 – Proposed HGV Routes - Principal Site and Cable Route Corridor.
 - ii. Figure 2 – Abnormal Load Routes - Principal Site and Cable Route Corridor.
 - iii. Figure 3 – Construction Layout.

1.5.3 This document is also supported by the following ES Appendices:

- a. **Transport and Access Legislation, Policy and Guidance (Appendix 16-1 of the ES [EN010142/APP/6.2]);** and
- b. **Transport Assessment (TA) (Appendix 16-2 of the ES [EN010142/APP/6.2]).**

1.5.4 In addition, the following DCO drawings and plans have been referenced:

- a. **Streets, Rights of Way and Access (SRoWA) Plans [EN010142/APP/2.4];**
- b. **Traffic Regulation Measures Plans [EN010142/APP/2.5];** and
- c. Appendix C (Abnormal Indivisible Loads (AIL) Management Plan) of this **Framework CTMP.**

2. Existing Conditions

- 2.1.1 Details of the Site location as well as the existing conditions in terms of the local highway network, pedestrian and cycle routes and public transport networks (bus and rail) are provided in **Chapter 16: Transport and Access** of the ES [EN010142/APP/6.1] and the TA (**Appendix 16-2** of the ES [EN010142/APP.6.2]).

3. Future Highway Network

- 3.1.1 During the construction and operational phases, there are not expected to be any changes to the surrounding highway network within or in close proximity to the Scheme occurring as a result of other projects or schemes that should be considered.
- 3.1.2 The cumulative schemes for consideration have been agreed in consultation with Lincolnshire County Council and Nottinghamshire County Council. These schemes, for which development aligns to the peak construction year of 2026, are also set out within **Chapter 18: Cumulative Effects and Interactions** of the ES [EN010142/APP/6.1].

4. Policy and Best Practice

- 4.1.1 Details of the legislation and planning policy in relation to the assessment of transport and access are provided in **Appendix 16-1** of the ES [EN010142/APP/6.2].

5. Construction Movements

5.1 Introduction

- 5.1.1 This section provides a summary of the forecast Heavy Goods Vehicles (HGV), Light Goods Vehicles (LGV) and staff vehicle movements estimated during the construction phase of the Scheme in terms of vehicles, estimated number of movements (peak and average) and routing.
- 5.1.2 Further details are provided in the TA (**Appendix 16-2** of the ES [EN010142/APP/6.2]). This section provides an overview of the forecast construction movements as background information.

5.2 Construction Programme

- 5.2.1 The main construction phase for the Scheme is currently predicted to commence in late 2025, with the construction peak in terms of activity and vehicle movements expected to take place in 2026. The approach taken offers a reasonable worst-case assessment, as it is based on a relatively short construction period (24 months) that would generate the highest number of peak hour and daily road trips on the local network.

5.3 Construction Vehicle Movements

Principal Site

- 5.3.1 At the peak of construction, which will be around 3 to 6 months after the start of construction, the Principal Site will accommodate a maximum of 1,225 construction staff per day. On average there would be approximately 800 staff per day.
- 5.3.2 The Cable Route Corridor will require a maximum of 170 staff per day across the route. Four groups of 30 construction staff will travel to/ from any one of site accesses/ cable contractor compounds per day and two groups of 25 construction staff will travel to/ from any one of the Cable Route Corridor compounds per day.
- 5.3.3 All construction staff will travel to/ from the Principal Site or the Cable Route Corridor accesses between 06:00-07:00 and 19:00-20:00 for the 12-hour working day between 07:00-19:00 (on the weekdays and between 07:00-13:00 on Saturdays, there will be no work undertaken on Sundays or Public holidays). An internal shuttle bus service is anticipated to be utilised to transport construction staff within the various Principal Site working areas (and vice-versa). All staff arriving/ departing in one hour provides a worst-case assessment of the forecast vehicle trip generation of construction staff vehicles on the local highway network.
- 5.3.4 In addition to the construction staff traffic, there will be an average of 65-70 HGVs (130-140 two-way movements) and 30-35 LGVs (60-70 two-way movements) per day associated with the Principal Site over the construction period and a daily peak of 120 HGVs (240 two-way movements) and 60 LGVs (120 two-way movements). The HGVs and LGVs are expected to use the three Principal Site accesses located on the A631 Harpswell Lane and the access on the B1398 Middle Street. The HGV and LGV routes are expected to primarily follow the A631, B1398 and A15, as identified in **Figure 1 in Appendix B**.
- 5.3.5 In relation to the Cable Route Corridor, in addition to the construction staff, there is expected to be an average of 186 HGVs per day over the construction period and a daily peak of 272 HGVs. The HGVs are expected to use all the Cable Route Corridor accesses (except those on Torksey Ferry Road) and are expected to primarily follow routes along the A15, A631, A1500, A156, A57, B1241, Fillingham Lane, Kexby Lane, Cow Lane, Laneham Road and Cottam Road.
- 5.3.6 The forecast trip distribution of construction staff vehicles has been derived using mid-year (2020) population estimates extracted from all Middle Layer Super Layout Areas (MSOAs) within or partially within a 45km radius (approximately 60 minutes' drive time) of the Principal Site, using Access 2 on the A631 as the centre point. The 45km construction staff travel distance is based on professional judgement, experience from other DCO Solar schemes and is also in line with **Chapter 14: Socio- Economics and Land Use** of the ES [EN010142/APP/6.1]. Further details of the trip distribution and assignment of construction staff is provided within the TA (**Appendix 16-2** of the ES [EN010142/APP/6.2]).

- 5.3.7 In terms of construction staff vehicles, the following parameters have been included as part of the assessment within the TA (**Appendix 16-2** of the ES **[EN010142/APP/6.2]**):
- a. Based on information provided by the project team and as agreed with the respective LHAs, during the construction peak, it is anticipated that 600 construction staff (48% of persons at the construction peak) would be transferred to/ from the Principal Site by a shuttle service (e.g. coach).
 - b. It is expected that each of the shuttle services will have a capacity for 50 construction staff, meaning a peak of 14 external shuttle services will be required to pick-up construction staff in the morning and drop-off construction staff in the evening (accounting for a typical occupancy of 80% to 90%) during the peak construction period (2026).
 - c. To provide a robust assumption of vehicle movements, it is assumed that the external shuttle services will originate from the Principal Site in both the AM and PM development peak hours, equating to 28 vehicle movements in the AM and PM (14 outbound movements and 14 inbound movements, with a daily total of 56 vehicle movements associated with the shuttle service).
 - d. During the construction peak, 650 construction staff (52% of persons at the peak of construction) would travel by private vehicle with an average vehicle occupancy of 1.3 staff per vehicle, resulting in 500 staff vehicles (1,000 daily movements). This approach was agreed with the LHAs during consultation on 19 January 2023 and is based on previous large scale solar project experience and professional judgement.
- 5.3.8 In relation to the shuttle service provision, if additional demand is identified by the monitoring carried out as part of the Detailed CTMP(s) (which will be secured through the DCO), then additional shuttle services will be provided to further reduce the number of construction staff vehicles on the network.
- 5.3.9 Given the locations of the nearest rail and bus services/ stops to the Scheme and considering the public transport timetables in relation to the construction staff working hours, there will be limited opportunity for construction staff to travel to the Principal Site by rail or bus. Nevertheless, sustainable travel will be promoted for construction staff travelling to/ from the Principal Site with further details set out within this document. The above mode share is considered to provide a worst-case assumption in terms of the number of construction staff vehicles forecast based on previous experience of Solar Farm/ Energy Park projects and professional judgement.
- 5.3.10 The forecast distribution of HGVs, LGVs and construction staff vehicles across the four Principal Site access points is presented below in **Table 5-1**. The HGV and LGV routes to/ from the Principal Site Accesses are shown in **Figure 1** in **Appendix B**.
- 5.3.11 To provide the most robust assessment, the worst-case scenario has been assumed (i.e. all HGVs and LGVs will therefore access the Principal Site from the east via the A15 (50% from the A15 north and 50% from the A15 south)).

Table 5-1: Forecast Trip Distribution (Construction Accesses) for the Principal Site

Site Access	Description	Construction Staff, LGV and HGV (%)
Principal Site Access 1 (A631)	Three Site accesses serving primarily the northern section of the Principal Site	30%
Principal Site Access 2 (A631)		20%
Principal Site Access 3 (A631)		20%
Principal Site Access 4 (B1398 Middle Street)	One Site access serving the southern section of the Principal Site	30%
Total	-	100%

5.3.12 Based on the trip generation and distribution outlined above, the forecast peak daily trip generation for each of the Principal Site access points during the construction period (in terms of vehicles) is set out in **Table 5-2**.

Table 5-2: Forecast Peak Daily Construction Vehicles for the Principal Site

Site Access	HGVs	LGVs	Staff Vehicles	Shuttle Service**	Total Vehicles
Principal Site Access 1 (A631)	36	18	157	4	215
Principal Site Access 2 (A631)	24	12	96	3	135
Principal Site Access 3 (A631)	24	12	96	3	135
Principal Site Access 4 (B1398)	36	18	151	4	209
Total	120	60	500	14	694

**Difference in totals due to rounding. The values in the table represent total vehicles and not daily movements.*

***Each shuttle service to depart from and arrive back to the Site twice per the morning and evening i.e. 14 shuttle services picking-up and dropping-off staff in the morning, and 14 shuttle services in the evening*

5.3.13 A daily profile of overall construction movements (arrivals and departures) for the Principal Site is presented in **Table 5-3** which includes construction staff vehicles, shuttle services, LGVs and HGVs based on the anticipated travel patterns across the day.

Table 5-3: Forecast Peak Daily and Hourly Construction Vehicle Movements for the Principal Site

Hour	HGVs		LGVs		Staff (private vehicles)		Staff (shuttle service)		Total Vehicles	
	In	Out	In	Out	In	Out	In	Out	In	Out
06:00-07:00	0	0	0	0	500	0	14	14	514	14
07:00-08:30	0	0	0	0	0	0	0	0	0	0
08:30-09:30	15	15	8	8	0	0	0	0	23	23
09:30-10:30	15	15	8	8	0	0	0	0	23	23
10:30-11:30	15	15	8	8	0	0	0	0	23	23
11:30-12:30	15	15	8	8	0	0	0	0	23	23
12:30-13:30	15	15	8	8	0	0	0	0	23	23
13:30-14:30	15	15	8	8	0	0	0	0	23	23
14:30-15:30	15	15	8	8	0	0	0	0	23	23
15:30-16:30	15	15	8	8	0	0	0	0	23	23
16:30-19:00	0	0	0	0	0	0	0	0	0	0
19:00-20:00	0	0	0	0	0	500	14	14	14	514
Total	120	120	60	60	500	500	28	28	708	708

5.3.14 Further details of the assessment of the peak daily HGVs and LGVs is provided within the TA (**Appendix 16-2** of the ES [EN010142/APP/6.2]).

5.3.15 An HGV routing plan is shown in **Figure 1** in **Appendix B** identifying the key routes which will be used by HGVs and LGVs to travel to/ from each of the Principal Site access points. It should be noted that for the Principal Site, all HGVs (excluding abnormal loads) will be expected to avoid the local towns/villages such as Sturton by Stow and Willingham by Stow. A separate routing plan for abnormal loads is shown in **Figure 2** in **Appendix B** and further details on abnormal loads are set out within Section 6.6 and in **Appendix C (AIL Management Plan)** of this Framework CTMP.

5.3.16 The forecast trip distribution and assignment of construction staff vehicles, LGVs and HGVs are provided within the TA (**Appendix 16-2** of the ES [EN010142/APP/6.2]).

Cable Route Corridor

5.3.17 There is expected to be a daily peak of 170 construction staff and 272 HGVs (with an average of 186 HGVs per day across the construction period) associated with the Cable Route Corridor (over a six-month period).

5.3.18 Four groups of 30 construction staff will travel to/ from any one of the Site accesses/ cable contractor compounds per day and two groups of 25 construction staff will travel to/ from any one of the trenchless crossing compounds per day. This equates to a total of 170 construction staff for the Cable Route Corridor and trenchless crossing works. An average occupancy

of 1.3 staff per vehicle has been adopted for all construction staff trips, meaning at peak there will be a total of 131 cars/LGVs associated with the 170 construction workers (262 two-way vehicle movements). These would be distributed across any of the Cable Route Corridor and trenchless crossing Site compounds.

5.3.19 At peak (assuming a worst-case assumptions), there will be up to 65 HGVs travelling to/ from any one of the Site accesses/ cable contractor compounds per day and two groups of seven HGVs travelling to/ from any one of the trenchless crossing compounds per day. This equates to a total peak of 272 HGVs (544 two-way vehicle movements) for the Cable Route Corridor and trenchless crossing works.

5.3.20 A daily profile of overall construction vehicle movements (arrivals and departures) for the Cable Route Corridor is presented in **Table 5-4** and includes construction staff vehicles and HGVs based on the anticipated travel patterns across the day. As per the Principal Site, the construction staff working hours are 07:00-19:00 (12-hours) and HGVs are distributed across an eight-hour delivery period between 08:30-16:30.

Table 5-4: Forecast Peak Daily and Hourly Construction Vehicle Movements for the Cable Route Corridor

Hour	HGVs		Staff Vehicles (LGVs)		Total Vehicles	
	In	Out	In	Out	In	Out
06:00-07:00	0	0	131	0	131	0
07:00-08:30	0	0	0	0	0	0
08:30-09:30	34	34	0	0	34	34
09:30-10:30	34	34	0	0	34	34
10:30-11:30	34	34	0	0	34	34
11:30-12:30	34	34	0	0	34	34
12:30-13:30	34	34	0	0	34	34
13:30-14:30	34	34	0	0	34	34
14:30-15:30	34	34	0	0	34	34
15:30-16:30	34	34	0	0	34	34
16:30-19:00	0	0	0	0	0	0
19:00-20:00	0	0	0	131	0	131
Total	272	272	131	131	403	403

**Differences in totals due to rounding*

- a. The proposed accesses for the Principal Site are as follows, and are also shown in **Figure 16-2: Site Access Plan – Principal Site and Cable Route Corridor** of this ES [EN010142/APP/6.3]: Principal Site Access 1 – A631 Harpswell Lane/ School Lane T-junction;

- a. Principal Site Access 2 – A631 Harpswell Lane/ Harpswell Low Farm access (T-Junction);
- b. Principal Site Access 3 – A631 Harpswell Lane/ Harpswell Grange access (T-junction); and
- c. Principal Site Access 4 – B1398 Middle Street / Field access (T-Junction; located between Coachroad Hill and Harpswell).
- d. Additional four internal accesses and two emergency accesses:
 - i. Internal Access 1 – Access off School Lane;
 - ii. Internal Access 2 – Access off School Lane;
 - iii. Internal Access 3 – Access off Common Lane;
 - iv. Internal Access 4 – Access off Common Lane;
 - v. Emergency Access 1 - Access off Common Lane; and
 - vi. Emergency Access 2 – Access off Common Lane.

5.3.21 As shown in **Figure 1** in **Appendix B**, HGVs have been distributed across all the Cable Route Corridor accesses to provide a reasonable worst-case assessment of the peak daily HGVs travelling to/ from the Cable Route Corridor. The vehicle routing adopted for each access is summarised below:

- a. Cable Route Corridor Site Access 1 (via existing entrance into EDF Cottam Power Station off Torksey Ferry Road);
- b. Cable Route Corridor Site Access 1B (via Shortley's Road, south of Torksey Ferry Road);
- c. Cable Route Corridor Site Access 2 (via Torksey Ferry Road to the north.);
- d. Cable Route Corridor Site Access 3 (via Cottam Road to the south);
- e. Cable Route Corridor Site Access 4 (via Cottam Road to the north);
- f. Cable Route Corridor Site Access 5A (via Headstead Bank to the west);
- g. Cable Route Corridor Site Access 5B (via Headstead Bank to the east);
- h. Cable Route Corridor Site Access 6 (via High Street to the west);
- i. Cable Route Corridor Site Access 7 (via High Street to the west);
- j. Cable Route Corridor Site Access 8 (via High Street to the east);
- k. Cable Route Corridor Access 9 (via A1500 Stow Park Road to the south);
- l. Cable Route Corridor Access 10 (via A1500 Stow Park Road);
- m. Cable Route Corridor Access 11 (via A1500 Till Bridge Lane);
- n. Cable Route Corridor Access 12A (via A1500 Till Bridge Lane);
- o. Cable Route Corridor Access 12B (via Stow Park Road / Existing farm access track);
- p. Cable Route Corridor Access 12C (via Wooden Lane to access Cable Route Corridor to the west);

- q. Cable Route Corridor Access 12D (via Wooden Lane to access Cable Route Corridor to the east);
- r. Cable Route Corridor Access 13 (via B1241 Normanby Road to the west);
- s. Cable Route Corridor Access 14 (via B1241 Normanby Road to the east);
- t. Cable Route Corridor Access 15 (via South Lane);
- u. Cable Route Corridor Access 16 (via South Lane);
- v. Cable Route Corridor Access 16B (via Fillingham Lane);
- w. Cable Route Corridor Access 17 (via Willingham Road); and
- x. Cable Route Corridor Access 18 (via Cow Lane).

5.4 Vehicle Types

5.4.1 It is expected that the majority of vehicles accessing the Scheme during the construction phase will be classified under the 'normal' size category (i.e. transit vans and HGVs). Based on the experience of vehicles required for other similar solar projects, it is anticipated that the following vehicle types will serve the Scheme during the construction phase:

- a. Cars;
- b. Tractors;
- c. Small vans;
- d. 10m rigid vehicles;
- e. Box vans;
- f. 8-wheeler rigid lorries;
- g. Concrete mixers;
- h. Articulated lorries (13.5m to 16.5m); and
- i. Abnormal Indivisible Loads (AILs)/ Abnormal Loads.

5.4.2 Vehicle swept paths have been carried out for a cable drum transporter (23m in length) for the relevant proposed construction access points across the Scheme. This represents the abnormal vehicle which will transport cable drums to/ from the Cable Route Corridor and is therefore considered to be robust. For accesses required during construction that do not form part of the cable installation corridor, the accesses are designed to cater for 16.6m Low Loader vehicles. Supporting improvements (e.g. local carriageway widening and vegetation clearance) is proposed to take place within the highway boundary and/ or Order limits if required. Drawings showing the proposed swept paths are held within **Appendix A**.

5.5 Plant Requirements

5.5.1 The typical plant requirements (and associated vehicle types) for the trenchless cabling techniques (such as Horizontal Directional Drilling (HDD) or thrust boring) during the construction works are listed below:

Launch Pits

- a. Articulated lorry for delivery / pick up of the directional drill rig*;
- b. Three articulated lorries for delivery of cable;
- c. Three-axle rigid 30ft flatbeds for delivering temporary trackway;
- d. One telehandler anticipated to be delivered on 44ft articulated lorry or small crane;
- e. Two excavator (anticipated to be delivered and picked up with the telehandler);
- f. Two Vans;
- g. Beavertail Lorry & 1000 Gallon Tank (with 13m x 2.5m Rod boxes);
- h. HDD Rig*
- i. Tractor and Tanker (12.3m x 2.5m)*;
- j. Vehicle with 2 x 1000 Gallon Mixing Tanks (9m x 2.5m); and
- k. Mud Mixing Tank Unit (7.6m x 2.5m).

*Specific vehicle types will be selected upon the appointment of the contractor and set out within the Detailed CTMP(s)

Reception Pits

- a. Two excavators (anticipated to be delivered and picked up with the telehandler);
- b. Three articulated lorries for delivery of cable;
- c. Three-axle rigid 30ft flatbed for delivering temporary trackway;
- d. One telehandler anticipated to be delivered on articulated lorry; and
- e. One flatbed lorry for the delivery of cement bound sand.

5.5.2 The above are expected to be sourced locally and will be delivered to the Site either individually driven (larger units) and/ or by plant haulage.

5.6 Abnormal Vehicles

5.6.1 Abnormal vehicles are expected to be required to transport the transformers to the Principal Site for the on-site Substations as well as cable drums for the Cable Route Corridor. The following abnormal vehicles are expected to be utilised during the construction phase to transport the indivisible loads:

- a. A 16 axle Small Girder Trailer – a 60.3m 49m length vehicle (including rear tractor unit) to deliver the transformers to the Principal Site via Access 1 on the A631 and Access 4 on the B1398 Middle Street (arrival only, as the vehicle would be disassembled prior to egressing the Site) (swept paths for the Principal Site are included in **Appendix A**); and
- b. Several 23.1m length vehicles to transport cable drums to/ from the Cable Route Corridor via multiple access points (arrivals and departures) (swept paths for the Cable Route Corridor are included in **Appendix A**).

5.6.2 A specialised haulage service will be employed to allow these components to be transported with the necessary escort, permits and traffic management, with the applicant consulting the relevant highways authorities to ensure the

correct permits are obtained. This is a standard measure to help accommodate AILs and will therefore be included within the DCO submission, secured by this Framework CTMP. The police will also be given advanced notification under the Road Vehicle Authorisation of Special Types Order 2003 (Ref. 2).

- 5.6.3 The abnormal vehicles will be required to follow the abnormal vehicle routing strategy as shown in **Figure 2** in **Appendix B** when travelling to/ from the Scheme. A number of highway improvements will be required to accommodate abnormal vehicles. Further details of these improvements are set out within **Appendix C (AIL Management Plan)** of this Framework CTMP.
- 5.6.4 Due to the constrained nature of Torksey Ferry Road, no abnormal load vehicles will access Torksey Ferry Road to facilitate the cable installation works into Cottam Power Station. Furthermore, no construction HGVs will pass through the village of Rampton. Construction HGVs will use the dedicated haul route within the Order limits to the west of the Cottam power station site.

6. Site Access, Layout and Routing

6.1 Introduction

- 6.1.1 During the construction phase, the Scheme will be served by a number of proposed access points. These will be designed with adequate visibility for construction vehicles to accommodate swept paths. Supporting improvements (e.g. local carriageway widening and vegetation clearance) to take place within the highway boundary and/ or Order limits if required. The Principal Site will have three access points from the A631 Harpswell Lane and one from the B1398 Middle Street. In addition, there will be four secondary accesses for construction, operation and decommissioning, two off School Lane and two off Common Lane, and two accesses provided for emergency use only during operation, both off Common Lane. The Cable Route Corridor will be served by 24 access points across Lincolnshire and Nottinghamshire, in addition to two of the Principal Site access points on the A631 and the Principal Site access point on the B1398. The proposed access locations for the Scheme are illustrated on **Figure 3** in **Appendix B**.
- 6.1.2 The proposed accesses for the Principal Site will be utilised during both the construction and operational phases. The accesses to the Cable Route Corridor will be reinstated after construction with the exception of the access into the Substation which will be retained for the operation phase.
- 6.1.3 The proposed Site layout for the construction phase is shown on **Figure 3** in **Appendix B**. This shows the proposed access arrangements and internal construction routes, as well as construction compound locations for the Principal Site and Cable Route Corridor. The internal construction routes are indicative and may be refined at Detailed Design stage.

Site Access Arrangements

- 6.1.4 The proposed accesses for the Principal Site are as follows:

- a. Principal Site Access 1 – A631 Harpswell Lane/ School Lane T-junction;
 - b. Principal Site Access 2 – A631 Harpswell Lane/ Harpswell Low Farm access (T-Junction);
 - c. Principal Site Access 3 – A631 Harpswell Lane/ Harpswell Grange access (T-junction); and
 - d. Principal Site Access 4 – B1398 Middle Street / Field access (T-Junction; located between Coachroad Hill and Harpswell).
 - e. Additional four internal accesses and two emergency accesses:
 - f. Internal Access 1 – Access off School Lane;
 - g. Internal Access 2 – Access off School Lane;
 - h. Internal Access 3 – Access off Common Lane;
 - i. Internal Access 4 – Access off Common Lane;
 - j. Emergency Access 1 - Access off Common Lane; and
 - k. Emergency Access 2 – Access off Common Lane.
- 6.1.5 Principal Site Accesses 1 to 3 will primarily serve the northern section of the Principal Site utilising the existing internal tracks. Whilst Principal Site Access 4 (B1398 Middle Street) will primarily serve the southern section of the Principal Site.
- 6.1.6 The Principal Site Accesses offer the following benefits:
- a. Direct access from the A631 and B1398 Middle Street utilising existing T-junctions (to be improved as part of the Scheme);
 - b. Allow existing tracks/ routes within the Principal Site to be utilised which minimise the need to construct additional access tracks or for large amounts of vegetation removal to be required;
 - c. The accesses will be located on parts of the highway network which do not pose any problems in terms of highway safety (no serious accidents noted in the vicinity of the proposed access points);
 - d. The accesses will be located on sections of the carriageway where the required visibility splays will be provided in both directions (visibility splay requirements are included as part of **Appendix 16-2: Transport Assessment** of the ES, Section 8.4 [EN010142/APP/6.2]; and
 - e. The accesses will be used within the HGV routing strategy, to avoid narrow rural roads (where possible) and to utilise the close proximity (circa five to ten minutes' drive) to/ from the A15.
- 6.1.7 During the operational phase, it is assumed that all four Principal Site Accesses will remain in use.
- 6.1.8 Further to the above, several existing private access points into the Principal Site will be closed as part of the proposals for the Scheme, including in instances where an alternative (new) access is to be provided in support of the Scheme or where an existing access will be redundant (no longer required) with the Scheme in place (such as accesses to a field which will now hold Solar PV and be fenced). Further details relating to the above, including where road alterations such as kerb raising or line marking are

proposed to implement private access closures, are shown on the **Streets, Right of Way and Access Plans (SRoWA) [EN010142/APP/2.4]**.

6.1.9 Accesses proposed for the Cable Route Corridor:

- a. Cable Route Corridor Site Access 1 (via existing entrance into EDF Cottam Power Station off Torksey Ferry Road);
- b. Cable Route Corridor Site Access 1B (via Shortley's Road, south of Torksey Ferry Road);
- c. Cable Route Corridor Site Access 2 (via Torksey Ferry Road to the north.);
- d. Cable Route Corridor Site Access 3 (via Cottam Road to the south);
- e. Cable Route Corridor Site Access 4 (via Cottam Road to the north);
- f. Cable Route Corridor Site Access 5A (via Headstead Bank to the west);
- g. Cable Route Corridor Site Access 5B (via Headstead Bank to the east);
- h. Cable Route Corridor Site Access 6 (via High Street to the west);
- i. Cable Route Corridor Site Access 7 (via High Street to the west);
- j. Cable Route Corridor Site Access 8 (via High Street to the east);
- k. Cable Route Corridor Access 9 (via A1500 Stow Park Road to the south);
- l. Cable Route Corridor Access 10 (via A1500 Stow Park Road);
- m. Cable Route Corridor Access 11 (via A1500 Till Bridge Lane);
- n. Cable Route Corridor Access 12A (via A1500 Till Bridge Lane);
- o. Cable Route Corridor Access 12B (via Stow Park Road / Existing farm access track);
- p. Cable Route Corridor Access 12C (via Wooden Lane to access Cable Route Corridor to the west);
- q. Cable Route Corridor Access 12D (via Wooden Lane to access Cable Route Corridor to the east);
- r. Cable Route Corridor Access 13 (via B1241 Normanby Road to the west);
- s. Cable Route Corridor Access 14 (via B1241 Normanby Road to the east);
- t. Cable Route Corridor Access 15 (via South Lane);
- u. Cable Route Corridor Access 16 (via South Lane);
- v. Cable Route Corridor Access 16B (via Fillingham Lane);
- w. Cable Route Corridor Access 17 (via Willingham Road); and
- x. Cable Route Corridor Access 18 (via Cow Lane).

- 6.1.10 The proposed Cable Route Corridor Accesses listed above are in addition to those identified for the Principal Site on the A631 and the B1398 Middle Street, which could be utilised if required when connecting the Cable Route Corridor to the on-site Substations within the Principal Site. The proposed vehicle access arrangements for the Cable Route Corridor are shown in **Appendix A**

6.2 Access Layouts

- 6.2.1 The proposed layouts of the accesses to the Principal Site are shown within **Appendix A**. Local highway improvements (e.g. verge clearance, hedge cutting and/ or carriageway realignment) will be carried out at each Site access where required. A 6.0m carriageway width will be provided along internal construction routes to accommodate HGVs). The proposed Site access roads will be surfaced with a bound surfacing material over a minimum 20m distance from the junction, to minimise the transfer of material onto the public highway as a result of construction vehicles. Some partial or full road closures would be required for street works to enable safe construction. For further details refer to **Section 7.3** of this Framework CTMP.
- 6.2.2 The Site access roads have been designed to accommodate two-way HGV movements (excluding abnormal vehicles). There is expected to be a maximum of 46 HGV and LGV arrivals to or departures from the Principal Site during the busiest hours (refer to **Table 5-3** above). This equates to approximately one vehicle movement every one to two minutes. The proposed layout of the Principal Site accesses are considered to be appropriate for accommodating this level of activity.
- 6.2.3 The proposed layouts of the accesses to the Cable Route Corridor are shown within **Appendix A**. The construction access roads have been designed to accommodate two-way HGV movements (excluding abnormal vehicles) including the required load bearing capacity, load overhang and turning provisions as shown by the vehicle swept paths. The Cable Route Corridor accesses are expected to serve up to 68 HGVs and 131 staff vehicles (LGVs) (split across multiple accesses) per day during the peak construction period (refer to **Table 5-4** above). This level of activity is expected to be easily accommodated within the local highway network, and the design of the accesses will sufficiently accommodate this.

6.3 Access Tracks

- 6.3.1 Existing tracks which run throughout the Principal Site are expected to be utilised as internal routes to move construction vehicles and staff internally between different areas during the construction period. Crucially, this means that use of the existing highway network running through the Principal Site, including Common Lane and Kexby Road, as part of any internal routes will be minimised and avoided if possible. The indicative routes to be utilised along existing internal tracks have set out in the **Figure 3-1: Indicative Principal Site Layout Plan** of the ES [EN010142/APP/6.3] and further information related to the internal access tracks can be found in **Chapter 3: Scheme Description** of the ES [EN010142/APP/6.1]. The internal tracks

will enable free-flowing movement within the Site whilst removing construction traffic from local roads.

- 6.3.2 Additionally, appropriate management is expected to be sustained during the construction phase, including marshals and banksmen to manage the crossing of the local highways which are within the Scheme, such as School Lane and Common Lane. Further, consultation with the local highway authorities will be undertaken to identify the appropriate method of management of these points during the construction phase as part of the detailed design stage and set out within the Detailed CTMP(s).
- 6.3.3 Utilising existing internal routes also minimises the need for construction vehicles to use local rural roads such as Common Lane and Kexby Lane and minimises the need to build any new road infrastructure within the Principal Site. Some strengthening may be required to ensure that the existing internal routes are suitable for heavy traffic loads during the construction period.
- 6.3.4 The Cable Route Corridor will be utilised to transport materials, equipment and construction staff from the Cable Route Corridor access points along the route via a haul road.

6.4 Vehicle Swept Path (non-AIL)

- 6.4.1 The proposed routing strategy for HGVs (non-AIL) is shown in the TA (**Appendix 16-2** of the ES [EN010142/APP/6.2]). The location of accesses and proposed routes will ensure that larger vehicles take the most direct route to and from the Scheme, while minimising the number of turning movements. Drawings showing vehicle swept paths for a cable drum transporter (23.1m in length) or a 16.6m Low Loader vehicle (where relevant) are provided in **Appendix A**.
- 6.4.2 The swept paths demonstrate that non-AIL construction vehicles will be able to turn in/ out of the proposed accesses without overrunning any kerb lines. It should be noted that marshals will be in place to control HGV movements at the accesses to ensure these movements are carried out safely. An appropriate level of visibility will be achievable to/ from the accesses as set out below. No carriageway widening or amendments will be required outside of the Order limits.
- 6.4.3 Details related to the swept paths of AILs are set out in **Appendix C (AIL Management Plan)** of this Framework CTMP, which identifies locations of street alterations which would be required along the route.

6.5 Vehicle Routing

- 6.5.1 The HGV routing to/ from the Principal Site is shown **Figure 1** in **Appendix B** and shows the routes to/ from the four accesses for the Principal Site along the A631, B1398 Middle Street and A15. These routes provide wider connection towards the M180 to the north and the A46 and A57 to the south, this routing strategy reflects the most suitable routes available to assist the delivery drivers with the most appropriate routes to/from the strategic network to the Site.

- 6.5.2 Additionally, the HGV routing shown in **Figure 1** in **Appendix B** includes the routing of the HGVs to/ from the Cable Route Corridor Accesses. In principle, the routing is expected to follow the same as those identified for the Principal Site utilising the A15, A631 as well as the A1500 and the A156 before utilising more local roads (where possible, routes through local villages have been avoided).
- 6.5.3 No construction traffic will be routed passed within 200m of the Ashton's Meadow Site of Special Scientific Interest (SSSI), thus avoiding any potential degradation to sensitive habitats from vehicle pollutants.

6.6 Abnormal Indivisible Loads

- 6.6.1 An assessment of the abnormal vehicles required for the Principal Site and Cable Route Corridor is provided within **Appendix C (AIL Management Plan)** of this Framework CTMP.. It should be noted, a further detailed assessment of the abnormal vehicle route will be carried out by an abnormal loads specialist to assess the movement associated with the delivery of a transformer as part of the detailed design stage. Upon the review of the findings, improvements will then be carried out within the Order limits and the movements will take place subject to the management measures.
- 6.6.2 The nature of the delivery is such that an AIL(s) will only be required when the transformer is transported to the Principal Site, as the vehicle will be dis-assembled and take the form of a standard vehicle prior to its departure. **Appendix C (AIL Management Plan)** of this Framework CTMP. includes the following:
- a. Route assessment for the delivery of transformers to the substations.
 - b. Route assessment for the delivery of cable drums to the temporary contractors' compounds.
- 6.6.3 AECOM conducted a high-level review of the proposed routing from the assumed Port of Entry (Immingham) to the Order limits and carried out vehicle tracking at several pinch points along the route, highlighting areas of works required, traffic management and constraints identified, this is further set out in the **Appendix C (Abnormal Indivisible Loads Management Plan)** of this Framework CTMP. A detailed AIL Management Plan including routes would be refined and confirmed prior to commencement of construction, which would be secured as part of the CTMP for the Scheme.

6.7 Visibility Splays

- 6.7.1 Drawings showing the required areas to be kept clear to achieve the appropriate visibility splays are in **Appendix A**. These drawings demonstrate that the desirable minimum visibility splays can be achieved through the clearance of vegetation etc. within the highway boundary and the land included within the Order limits. Further details of the calculations relating to the visibility splay requirements are set out within the TA (**Appendix 16-2** of the ES [EN010142/APP.6.2]).
- 6.7.2 It should be noted that speed surveys have not been conducted on Torksey Ferry Road as the existing road conditions would provide a disproportionately low 85th percentile speed for the purpose of deriving the

SSD, it is therefore proposed that the DMRB design requirement for 60kph is utilised for the road.

6.8 Car and Cycle Parking

- 6.8.1 In accordance with the peak parking demand identified in the TA (**Appendix 16-2** of the ES [EN010142/APP.6.2]) during the construction phase the Principal Site construction staff car parking spaces will be capped at 500. Parking for construction staff will be provided within the Principal Site as follows:
- Principal Site Access 1 = 150 spaces (30%);
 - Principal Site Access 2 = 100 spaces (20%);
 - Principal Site Access 3 = 100 spaces (20%); and
 - Principal Site Access 4 = 150 spaces (30%).
- 6.8.2 Utilisation at each car park will be monitored and the potential to introduce additional parking during the peak construction period will be explored to ensure that parking does not occur outside of the Scheme Order limits.
- 6.8.3 An internal shuttle bus service will be provided to move staff from the car parks to different areas of construction within the Principal Site making use of the existing internal tracks where possible. Construction staff working on the Cable Route Corridor will access the relevant compounds/ access points directly and would not travel to the Principal Site.
- 6.8.4 A sufficient number of cycle parking spaces within the Principal Site will be provided to encourage staff to travel by bicycle where viable. Currently it is envisaged that 12 cycle parking spaces (1% of the peak number of construction staff) will be provided within the Principal Site for construction and operational staff to use. There is no specific cycle parking standard for the land use of the Scheme, but based on professional judgement and the location of the Scheme in a rural setting, it is considered that this constitutes an appropriate provision. Depending on the compound design during the construction phase of the Scheme, there may be an opportunity to provide more. Cycle parking provision will also be monitored and increased if required.
- 6.8.5 Along the Cable Route Corridor, the number of parking spaces provided will be determined based on the number of construction staff required at each compound, there will be a sufficient amount of space assigned within the Cable Route Corridor compounds to accommodate the number of spaces required during the peak period of works. Further details and car parking strategy will be set out within the Detailed CTMP. The usage of the car parks will be monitored and the potential to introduce additional parking will be explored during peak construction if required, to ensure that parking does not occur outside of the Scheme Order limits.

6.9 Construction Compounds

- 6.9.1 The main construction compounds will be accessed via the accesses from the A631 and B1398 Middle Street, with each containing offices, mobile welfare units, canteens, storage and waste skips, a power supply, parking

areas and space for storage, a wheel washing facility, a bunded area for refuelling and the storage of liquids, as well as unloading and turning areas.

6.9.2 Five temporary construction compounds will be located across the Principal Site, the locations of the compounds are shown in **Figure 3** in **Appendix B**.

6.9.3 Construction compounds will also be located at specified positions within the Cable Route Corridor, accessed via the nearest access point to that compound. The proposed indicative locations of the Cable Route Corridor construction compounds are shown in **Figure 3** in **Appendix B**.

7. Management and Measures

7.1 Introduction

7.1.1 This section of the Framework CTMP outlines the construction traffic and travel plan management measures that will be implemented in support of the Scheme, to minimise adverse impacts on the surrounding networks during the construction phase.

7.2 Management Measures and Controls

HGV Measures and Controls

7.2.1 The following measures will be implemented to manage HGV deliveries to the Scheme and further details are set out under separate headings below:

- a. Delivery Management System (DMS) and Traffic Management and Monitoring System (TMMS);
- b. Suitable HGV Routes;
- c. HGV and LGV Timing Restrictions;
- d. HGV Monitoring;
- e. HGV Emission Standards;
- f. Communications Strategy;
- g. Road Condition Surveys;
- h. Site Access Arrangements;
- i. Escort, permits and traffic management for AILs;
- j. Interactions with pedestrians and cyclists; and
- k. Marshals and Site Management.

CLOCS Standard

7.2.2 The Construction Logistics and Community Safety (CLOCS) Standard (Ref. 1) is a national industry standard that should be applied to all construction projects and programmes to ensure safe, efficient and environmentally friendly construction vehicle journeys. The principal contractors and fleet operators shall comply with the requirements of the CLOCS Standard by implementing a Construction Logistics Plan (CLP) and ensuring the following:

- a. Vehicle routes to and from the Site committed in the CLP are specified, communicated and followed;
- b. Ground conditions of the Site are suitable for vehicles and vehicles are fitted with appropriate safety features;
- c. Access to and egress from the Site is managed, marked, understood and clear of obstacles; and
- d. Collate annual collisions and emissions performance information and, where necessary, produce an improvement plan.

Delivery Management System (DMS) and Traffic Management and Monitoring System (TMMS)

- 7.2.3 A DMS will be implemented to control bookings of HGV and LGV deliveries from the start of the construction period. This will be used to effectively plan all HGV and LGV deliveries in accordance with the construction programme, regulate the flow of HGVs and LGVs via timed delivery slots and monitor compliance of HGV routing. In addition, measures will be in place to ensure no queuing back from accesses onto the surrounding road network occurs.
- 7.2.4 A TMMS will be developed. The TMMS will provide details of the technologies and other means employed to monitor HGVs and LGVs travelling to/ from the Scheme (e.g. Global Positioning System (GPS), Automatic Number Plate Recognition (ANPR)). This will enable the Applicant to monitor the following:
- a. Compliance with the HGV routes;
 - b. Compliance with HGV and LGV limits in terms of number of deliveries arriving and departing at any one time and over the course of the day; and
 - c. Compliance with the timing restrictions.
- 7.2.5 If a complaint is made in relation to inappropriate routes being used, then this will be cross-referenced with the TMMS to allow appropriate actions to then be taken.
- 7.2.6 The precise form of DMS and TMMS would be determined following the appointment of a contractor and will include a summary of the contractual requirements with which those visiting the Site will have to adhere, along with the measures to be taken for non-compliance. This could include, for example, implementing a three-strike system for contractors which could lead to financial penalties.

HGV Routes

- 7.2.7 HGVs will be required to comply with the proposed routing strategy outlined in the TA (**Appendix 16-2** of the ES [EN010142/APP/6.2]) in accordance with the DMS and TMMS. The following strategies will be applied:
- a. Routing strategy for HGVs (excluding abnormal vehicles) for the Principal Site;
 - b. Routing strategy for HGVs (including abnormal vehicles) for the Cable Route Corridor; and

- c. Routing strategy for abnormal vehicles for the Principal Site informed by **Appendix C (AIL Management Plan)** of this Framework CTMP.

7.2.8 In the case of exceptional circumstances where the proposed routing to the Scheme is compromised due to an incident or road closure for example, then it is considered acceptable for HGVs to be redirected via an appropriate alternative route or to deliver outside of the established scheduling if required.

HGV and LGV Timing Restrictions

7.2.9 To reduce the potential impact of HGV and LGV deliveries, the arrival and departure times will be managed to minimise the number of HGVs and LGVs travelling to the Site during the actual highway network peak hours; identified within the TA (**Appendix 16-2** of the ES [EN010142/APP/6.2]) as 07:30-08:30 and 16:30-17:30. For example, HGVs and LGVs will be arranged to avoid being released from the Site during the actual PM highway network peak hour.

7.2.10 The timing restrictions, considered likely to be implemented at this stage are:

- a. No arrivals or departures on a weekday between 07:30 and 08:30, and between 16:30 and 17:30;
- b. No arrivals or departures on a weekday before 07:00 or after 19:00;
- c. No arrivals or departures on a Saturday before 07:00 or after 13:00; and
- d. No arrivals or departures on Sundays or public holidays.

7.2.11 The restrictions imposed on deliveries by HGVs and LGVs will be set out within the DMS and TMSS.

HGV Monitoring

7.2.12 The Applicant will implement a monitoring system whereby the route of all HGVs travelling to and from the Scheme is recorded such that non-compliance with the CTMP can be identified and measures taken. The precise form this monitoring will take will be included within the Detailed CTMP.

7.2.13 The Applicant is committed to undertaking robust data collection and formulating a reporting mechanism to record collisions and near misses associated with construction traffic or on construction routes. If there is a pattern of incidents that is apparent from information collected then this will be reviewed in terms of understanding causality. Understanding the underlying cause of any road safety issues will inform the approach to their resolution. Where relevant, operational measures will be considered and introduced by the Applicant to reduce the likelihood of occurrence, e.g. driver training. The Applicant will raise and discuss any apparent road safety issues with the relevant LHA.

HGV Emissions

7.2.14 All HGVs routing to the Scheme (with the exception of vehicles used for the transportation of AILs including cranes) will be required to be compliant with the latest emission standards at the time of construction. The HGVs will be compliant with 'Euro VI' emissions standards.

Communications Strategy

- 7.2.15 A Communications Strategy will be developed by the Applicant to ensure that the measures contained within the Detailed CTMP are communicated to the workforce. This would include an information pack setting out the contractual requirements which will be provided to potential staff. Furthermore, regular meetings will be held with contractors to discuss HGV and LGV management and to address any issues associated with travel to/ from the Site as well as to relay information including any restrictions and requirements which should be followed.

Highway Condition Surveys

- 7.2.16 A road condition survey will be carried out pre-construction, during construction and after construction to identify any impacts/ defects which are a result of the development that need to be remediated. At this stage, it is proposed to carry out a highway condition survey at the following locations within the Order limits (see the Study Area shown on **Figure 16-1** of the ES [EN010142/APP/6.3] for reference):

- a. A631 covering the Order limits between Principal Site Accesses 1, 2 and 3;
 - b. B1398 Middle Street covering the Order limits associated with Principal Site Access 4;
 - c. Torksey Ferry Road covering the Order limits associated with Cable Route Corridor Accesses 1, 1B and 2;
 - d. Cottam Road covering the Order limits associated with Cable Route Corridor Accesses 3 and 4;
 - e. Headstead Bank covering the Order limits associated with Cable Route Corridor Accesses 5A and 5B;
 - f. A156 High Street covering the Order limits associated with Cable Route Corridor Accesses 6, 7 and 8;
 - g. A1500 Stow Park Road and A1500 Till Bridge Lane covering the Order limits associated with Cable Route Corridor Accesses 9, 10, 11 and 12A, 12B, 12C and 12D;
 - h. B1241 Normanby Road covering the Order limits associated with Cable Route Corridor Accesses 13 and 14; and
 - i. South Lane, Fillingham Lane and Cow Lane covering the Order limits associated with Cable Route Corridor Accesses 15, 16, 17 and 18.
- 7.2.17 In addition, a separate highway condition survey will be carried out for the abnormal vehicle route for the transformer to the Principal Site, covering the route between the A15/ A631 roundabout and Principal Site Accesses 1 and 4 on the A631 and the B1398 Middle Street. This will be used to identify any defects that arise to highways assets/ verges as a result of abnormal loads for reinstatement, including at the A15/ A631 roundabout junction. As above, this survey would be carried out both before and after any abnormal loads travel on the network.
- 7.2.18 Where the pre-condition survey identifies that there would be a benefit to having appropriate measures in place to protect or maintain the road

surface, to reduce the likelihood of damage caused by construction vehicles, the Applicant will enter discussions with the LHA on this matter.

Site Access Arrangements

- 7.2.19 The Site access layouts have been designed to accommodate HGVs as shown by the vehicle swept paths held in **Appendix A**.
- 7.2.20 A hardstanding surface will be provided at the proposed accesses to ensure the weight of the HGVs can be accommodated. In addition, wheel washing facilities will be provided at every access to minimise mud from being trafficked onto the highway.
- 7.2.21 Vegetation clearance will be carried out at the proposed Site accesses, where required, in order to achieve appropriate levels of visibility, subject to agreement with the LHAs.
- 7.2.22 The detailed design of the Site accesses will include measures to minimise vehicles obstructing the public highway at the access points. This will include:
- a. Any gates required or currently in situ will be located a sufficient distance into the Site to ensure that HGVs can pull off the public highway fully without causing an obstruction. All gates will open inwards to the Site.
 - b. Internal Site layout will ensure that all HGVs access and egress the Site in a forward gear, with any turning required to be accommodated on-site.
 - c. Deliveries will be managed to avoid entering and exiting vehicles meeting at an access point. In the unlikely event that this occurs, the entering vehicle will have priority, and the internal Site layout will be designed to ensure that there is sufficient space for the exiting vehicle to wait within the Site and allow the entering vehicle to pass without obstruction. Sufficient forward visibility will be provided to enable this to take place safely.
 - d. Positioning of suitably qualified banksmen at the proposed accesses for the Principal Site and Cable Route Corridor, to allow all vehicle arrivals and departures to be safely controlled during the construction period.
 - e. Implementing traffic management (e.g. advanced signage to advise other users of the works) and providing manned controls at each crossing point (i.e. marshals/ banksmen). The default priority will be for construction traffic to give-way to other road users

Abnormal Indivisible Loads

- 7.2.23 Before the movement of any AILs the police will be given advanced notification as required under the Road Vehicle Authorisation of Special Types Order 2003 (Ref. 2).
- 7.2.24 In addition, communication and co-ordination will occur with both National Highways (as appropriate) and the LHAs before the AILs are required on-site to ensure sufficient notification is provided. This also includes the co-ordination of the temporary removal and subsequent re-instatement of signage and street furniture. The matter is addressed within the **Appendix C (AIL Management Plan)** of this **Framework CTMP**.

- 7.2.25 The transportation of AILs will be undertaken in line with the Government and the LHAs requirements, and timely applications will be made. Advance notice will be given to the Department for Transport, National Highways, the relevant highway authorities, the police and bridge owners as necessary in line with the requirements depending on the vehicles' weight, width and length.

Pedestrians and Cyclists

- 7.2.26 The **Framework Public Rights of Way Management Plan [EN010142/APP/7.16]** sets out the measures which have been included as embedded mitigation within the ES, to minimise the traffic impacts of the Scheme on pedestrians, cyclists and equestrians during the construction and decommissioning phases. It should be noted that all pedestrian and cycle routes will be maintained and remain unobstructed at all times when in use, to ensure the continued safe passage of the public including when using the PRow through the Site and at crossing points. The measures will be secured through the DCO, primarily by this document, as well as via the **Framework CEMP [EN010142/APP/7.8]**.

Marshals and Site Management

- 7.2.27 A suitably qualified marshal will be positioned at each of the proposed Site accesses and at internal crossing points (as well as any locations which may require temporary traffic management) when required, to allow vehicle arrivals and departures, as well as internal vehicle movements to be safely controlled during the construction period. This includes the network of internal access routes and the PRow crossing points within the Scheme. Visibility will be maximised between construction vehicles and other users at the crossing points (through hedgerow clearance for example), and advanced signage will be provided to warn users of the potential presence of construction vehicles and crossing points. Manned controls will be provided at each crossing point (marshals and gates), with a default priority that construction traffic will give-way to other users.

Staff Measures and Controls

- 7.2.28 Staff movements will be managed through the implementation of the following measures:
- a. A cap on construction staff vehicle parking (monitored and with some flexibility provided if required to prevent any off-site parking);
 - b. Encouraging car sharing;
 - c. Staff arrival and departure times;
 - d. External shuttle bus service providing transport between temporary accommodation/ residential centres and the Principal Site; and
 - e. Internal shuttle bus service in order to transfer construction staff to different parts of the Principal Site (if required).

Cap on Construction Staff Vehicles

- 7.2.29 The measures to reduce vehicle trips above are outline measures with details to be defined when more information on workforce locations is known. This is typical of a Framework Travel Plan at this stage of the

planning process. To ensure the ultimate effectiveness of the proposed measures, and to provide additional confidence to the LHAs, a cap on construction staff parking will be applied and monitored. This will ensure that the level of traffic generated does not exceed that assessed within **Chapter 16: Transport and Access** of the ES [EN010142/APP/6.1].

- 7.2.30 The Applicant has demonstrated that an average occupancy of 1.3 persons per vehicle would not result in a significant effect in EIA terms (see Section 16.8 of **Chapter 16: Transport and Access** of the ES [EN010142/APP/6.1]), and therefore it is proposed to establish a daily vehicle cap at this level, which is 500 staff vehicles for the Principal Site (split across the four access points).
- 7.2.31 The capacity of each car park is set to be limited to between 100-150 vehicles, to accommodate (but limit) the expected parking demand of construction staff within the Principal Site during the peak period, with additional parking available for shuttle buses. The usage of the car park will be monitored and the potential to introduce additional parking during the peak construction period will be explored to ensure that parking does not occur outside of the Order limits.
- 7.2.32 Additional car parking spaces will be provided for construction staff within the construction compounds serving the Cable Route Corridor, as staff will be travelling directly to the Cable Route Corridor.

Car Sharing

- 7.2.33 To reduce the potential impact of vehicles associated with the local staff during the construction period, the Applicant will implement measures to encourage car sharing to reduce the number of vehicles travelling to/ from the Scheme each day. The benefits of car sharing will be promoted to encourage multi-occupancy vehicle use, such as reduced fuel costs and ease of parking with guaranteed spaces for those car-sharing within the compounds. A Car Share Scheme will be implemented to match potential sharers and to help staff identify any colleagues who could potentially be collected along their route to/ from the Scheme. The limited car parking and the use of the shuttle service or the Principal Site will encourage staff to travel together.
- 7.2.34 Due to the rural location of the Scheme, it is anticipated that the majority of staff will drive or be a vehicle passenger to / from the Scheme. For the purpose of the assessment carried out within the TA (**Appendix 16-2** of the ES [EN010142/APP/6.2]), it is assumed that the staff vehicles travelling to the Principal Site will have an average vehicle occupancy of 1.3 persons. The average vehicle occupancy has been identified from previous experience of large-scale solar farms and professional judgement. However, a higher average occupancy level will be aspired to, in order to further reduce the impact of the development on the local network and the SRN.

Staff Arrivals and Departures

- 7.2.35 The proposed working hours of construction staff are expected to be 07:00-19:00 (12-hour shift) resulting in construction staff travelling to/ from the Scheme outside of the traditional highway network peak hours, which makes use of the spare capacity on the highway network outside of the peak times.

- 7.2.36 Construction staff will be expected to arrive in the hour before the start of work (06:00-07:00) and to depart in the hour after the end of the working day (19:00-20:00). Based on the above, all staff are expected to avoid the traditional morning and evening highway network peak hours. The proposed working hours are therefore designed to minimise additional trips at the busiest times in terms of trips on the surrounding highway network. If any works are required outside of the above working hours, then these will comply with any restrictions agreed with the relevant planning/ highway authorities.
- 7.2.37 To minimise additional vehicle trips on local roads, construction staff will be directed to travel to the Scheme via the main routes such as the A631 to the north, the A57 to the south, the A1500 to the south, the A156 to the west and the A15 to the east, which will provide the most direct access to the Scheme and therefore limit the impact on local/ rural roads.

Shuttle Bus Service

- 7.2.38 As agreed with the LHAs, an external shuttle service is expected to be used to transport approximately 575 construction staff (47%) staying within local accommodation in the vicinity of the Scheme. At this stage of the Scheme, it is expected that each of the shuttle services will have capacity for 50 construction staff, meaning a peak of 14 shuttle services will be required to pick-up construction staff in the morning and drop-off construction staff in the evening (accounting for a typical occupancy of 80% to 90%).
- 7.2.39 In relation to the shuttle service provision, if additional demand is identified by the monitoring carried out as part of the Detailed CTMP then additional shuttle services will be provided to accommodate these and to further reduce the number of construction staff vehicles on the network.
- 7.2.40 The external shuttle service will primarily be provided for transporting staff between the Principal Site and appropriate temporary accommodation and residential centres in the vicinity of the Scheme, considered likely to be Gainsborough (north), Scunthorpe (north), Doncaster (north), Lincoln (south), Retford (west) and Newark on Trent (south). A detailed assessment of the location of temporary accommodation (for non-local staff) and staff residential locations is provided in **Chapter 14: Socio-economics and Land Use** of the ES [EN010142/APP/6.1]. Areas with the greatest concentration of staff will be targeted to maximise the number of staff being transferred by shuttle service. The exact pick-up/drop-off locations of construction staff will be confirmed within the Detailed CTMP.
- 7.2.41 With regards to the external shuttle service, the following assumptions have been adopted:
- a. The shuttle buses will travel between the Principal Site Accesses and temporary accommodation/ residential centres to transport all non-local staff to/ from the Scheme;
 - b. The shuttle buses will depart from the Principal Site, travel to the local temporary accommodation/ residential centres to pick-up the construction staff and return to the Scheme within the hour prior to the start of work;

- c. The shuttle buses will depart from the Principal Site and travel to the temporary accommodation/ residential centres to drop-off the construction staff within the hour after the end of the working day (before returning back to the Scheme); and
 - d. Each shuttle bus will be expected to have a typical occupancy of 80% to 90% when transporting construction staff to/from the Scheme; and
- 7.2.42 The primary aim of the external shuttle service is to minimise the number of private vehicle trips taking place on the local highway network during the construction period.
- 7.2.43 Within the Principal Site, an internal shuttle service is expected to use the internal tracks to transport staff internally. This will help prevent additional trips between the Site accesses on the surrounding highway network.

7.3 Additional Measures and Controls

Stage 1 Road Safety Audit

- 7.3.1 A Stage 1 Road Safety Audit (RSA) will be carried out for the following the submission of the DCO:
- a. Preliminary design of the proposed Site access points and crossovers for the Scheme; and
 - b. Proposed highway improvements as identified above.
- 7.3.2 The highway improvements will be secured by the DCO, and further details of the works required to deliver the improvements will be provided in the Detailed CTMP.
- 7.3.3 The Stage 1 RSAs undertaken will be compliant with DMRB GG119 (Ref. 3) (this will be done for any new or modified accesses within the Order limits, subject to terms of whether an RSA would be required, depends on the nature/ significance of the works and opinion of the LHA - a modified access may require an RSA, depending on nature of the modifications (in this case, it has been assumed that all modified access points would require an RSA)).

Traffic Management Measures

- 7.3.4 Temporary Traffic Management (TTM) measures will be required to accommodate the construction of each of the access points (proposed and existing access points which are set to be modified) and are included within the DCO submission. Furthermore, TTM is expected to be required to accommodate the installation of the Cable Route Corridor across highways where trenchless Horizontal Directional Drilling (HDD) is not employed. The location of the proposed TTM is set out within the **Traffic Regulation Measures Plans[EN010142/APP/2.5]**. It should be noted that trenchless methods will be utilised when installing the cable at the Cable Route Corridor in order to avoid any lane or road closures on these parts of the network. Due to the need for construction vehicles to enter and travel along Torksey Ferry Road from the haul route accessed via Cottam Road, traffic management will be in place to ensure that construction traffic and users of

the existing byway open to all traffic are safely separated. Further details will be provided as part of the Detailed CTMP.

- 7.3.5 Due to the constrained nature of Torksey Ferry Road, no abnormal load vehicles will access Torksey Ferry Road to facilitate the cable installation works into Cottam Power Station. Furthermore, no construction HGVs will pass through the village of Rampton (west of Torksey Ferry Road). Construction HGVs will use the dedicated haul route within the Order limits to the west of the Cottam power station site to access the road.

Highway Measures

- 7.3.6 The following highway works are proposed as part of the Scheme:

a. Within the Order limits:

- i. Street works to facilitate cable installation works;
- ii. Alteration of road layouts, including modifications to road markings and temporary removal of signage to facilitate abnormal load manoeuvres;
- iii. Some private field accesses will be closed, whilst others will be retained and improved. Some of these works will require alterations to the adjacent road layout;
- iv. Junction improvements at Junction of A631 Harpswell Lane with School Lane, Junction of A1500 Tillbridge Lane with Stow Park Road, and Junction of Stow Park Road with Wooden Lane;
- v. Repair of existing carriageway at Torksey Ferry Road – the road was noted as having poor condition from visual inspections, therefore the existing carriageway will need to be surveyed, defects identified and any defects in the existing carriageway repaired, which will comprise the placement of compacted aggregate;
- vi. Alteration of road layout to facilitate localised carriageway widening for construction vehicles on Fillingham Lane, South Lane, and Wooden Lane;
- vii. Provision of new access points; and
- viii. Construction of passing bays, vegetation clearance and potential carriageway widening.

b. Off-site:

- i. Implementation of local off-site highway improvements to accommodate abnormal loads travelling to the Principal Site, e.g. pavement protection, temporary removal of street furniture, vegetation clearance including overhanging trees and lifting overhead cables, as required.

- 7.3.7 The Order limits include the areas required to accommodate the above improvements where required. Plans showing the **Traffic Regulation Measures Plans [EN010142/APP/2.5]** have been submitted with the DCO application. The proposed extent of any carriageway works to be delivered in

support of the Scheme is to be agreed with the LHAs and further details related to the works required will be supplied at the detailed design stage.

- 7.3.8 Temporary partial or full road closures will be required in some locations to complete the works associated with the Scheme, including construction of new access points, improvements to existing accesses, highway improvements such as passing bays and installation of the cable where it crosses existing roads.
- 7.3.9 Any partial or full road closures are expected to be for a short duration to minimise impacts on the local highway network. Full closures would only be required where and when necessary on narrow roads where options for retaining public access through the use of two-way traffic signals is not feasible. In addition, wherever possible access for emergency vehicles, pedestrians and cyclists will be maintained during the temporary closures. Advance warning will be provided in line with local highway authority guidance and diversion routes will be put in place. No permanent road closures will be required. Management measures will be finalised and set out in the Detailed CTMPs.
- 7.3.10 Where a full closure is required, the works will be carefully planned to ensure that the durations of any closures are minimised, and any full closure will include consideration of the continued access of any local residents or commercial businesses that fall within the area of the closure. The exact duration of any partial or full closure would be secured as part of the Detailed CTMP.
- 7.3.11 Below is a summary of the anticipated type of closures and durations by location. The closure durations noted in the table below are the estimated worst case duration required for any unique identified work. The durations represent the anticipated length of time required to complete the associated works, but the actual road closures may not be required for the full length of time.

Table 7-1 Potential Road Closures

Street	Closure Type	Anticipated Maximum Duration
A631 Harpswell Lane	Partial	4-6 weeks
School Lane	Full	6-8 weeks
Roundabout of A631 Harpswell Lane and B1398 Middle Street	Partial	1-2 days
B1398 Middle Street	Partial	4-5 weeks
Common Lane	Full	3-4 weeks (numerous closures of similar or less will be required)
Cow Lane	Full	4 weeks (numerous closures of similar or less will be required)

Street	Closure Type	Anticipated Maximum Duration
Willingham Road	Full	4-6 weeks
Fillingham Lane	Full	4 weeks (numerous closures of similar or less will be required)
South Lane	Full	6 weeks
Normanby Road	Partial	6-8 weeks
Wood Lane	Full	6 weeks
Stow Park Road	Full or Partial	4-5 weeks (full) 8-10 weeks (partial)
A1500 Tillbridge Lane	Partial	4-5 weeks
A1500 Stow Park Road	Partial	4-5 weeks
A156 High Street	Partial	6-8 weeks
Headstead Bank & Town Street	Full or Partial	6 weeks (full), 10 weeks (partial)
Cottam Road	Partial	6-8 weeks
Torksey Ferry Road	Full	4 weeks (aligns to Gate Burton)
Nightleys Road	Partial	2-3 weeks
Shortleys Road	Full	8 weeks (associated with the junction of Torksey Ferry Road and Shortleys Road which will include widening of access over the Seymour Drain)

7.3.12 Any requirement for temporary partial or full closure will be discussed and agreed with the LHAs and details/ mitigation and management will be set out within the Detailed CTMP(s) once the designated contractor has been appointed.

7.4 PRow

7.4.1 Access to all existing PRow (as well as any potential claimed PRow which could be implemented in time of the commencement of the construction phase) will be retained during the construction phase, with no PRow closures (except BOAT13) and a limited number of temporary local PRow diversions within the Cable Route Corridor when the cabling is installed or to physically separate these from the proposed construction routes. During the installation of passing bays and the upgrade to Torksey Ferry Road, which

will comprise the placement of compacted aggregate, it will be necessary to close a section of PRow NT|Rampton|BOAT13 (the exact length of the closure is not currently specified, however, it is expected to be similar to the works proposed by Gate Burton Energy Park Scheme which states a distance of circa 1.7km) for a maximum period of around four to six weeks. Prior to construction, the duration of the closure will be reviewed depending on existing road condition, construction sequencing, final design and weather conditions during the works, to reduce this as far as possible. Any diversion routes will be agreed with the local authorities prior to construction and will be detailed in the Detailed CTMP(s).

- 7.4.2 Further details of the anticipated interactions between construction works/routes and how the existing PRow will be managed during the construction phase are set out within the **Framework PRow Management Plan [EN010142/APP/7.16]**.

7.5 Combined Measures

- 7.5.1 The opportunity to combine mitigation measures (including some of the above measures) with the West Burton Solar Project, Cottam Solar Project and Gate Burton Energy Park schemes (see **Chapter 18: Cumulative Effects and Interactions** of the ES [EN010142/APP/6.1] and **the Joint Report on the Interrelationship with other National Infrastructure Projects [EN01042/APP/7.6]**) will be explored in order to reduce cumulative impacts during the construction phase. This could include sharing the shuttle service to transport construction staff to/ from multiple sites or sharing construction compounds to consolidate trips. Final details will be set out as the Scheme proposals are developed during detailed design and once further details in relation to the other solar farm schemes are known e.g. project timeframes and the approach for the shared sections of the Cable Route Corridor.
- 7.5.2 Further details related to the potential impact on PRow and combined mitigation measures to limit the impact of the cumulative consideration are set out within the **Framework PRow Management Plan [EN010142/APP/7.16]**.
- 7.5.3 It is proposed that a Joint CTMP document is to be prepared between the Scheme and the other solar DCOs post-consent to manage and mitigate cumulative effects, once further details are known on project timeframes and the approach for the shared Cable Route Corridor.
- 7.5.4 At present, there is no certainty that all of the schemes will be consented and therefore that a Joint CTMP would be required. If they are all consented, they may be subject to different requirements on construction traffic or timescales, which may make production of one document across all projects challenging. No single party has authority over another and each DCO only controls the activities for that project. For all these reasons, a firm commitment cannot be made to prepare or agree a Joint CTMP. Notwithstanding the above, it is the developers' intention to together develop a Joint CTMP and this approach has been agreed between the parties.
- 7.5.5 The Joint CTMP would support implementation of shared mitigation measures such as joint traffic management, joint consultation with

Lincolnshire and Nottinghamshire County Council traffic officers, combined vehicle access and routing plans, shared use of construction compounds, taking a holistic approach to construction traffic planning and management as well as considering the cumulative impact on PRow.

- 7.5.6 Further information is provided within the **Joint Report on the Interrelationship with other National Infrastructure projects [EN010142/APP/7.6]** submitted alongside the DCO application.

7.6 Management Structure

- 7.6.1 The overall management and implementation of the Detailed CTMP will be the responsibility of the Applicant. A Transport/ Travel Plan Co-ordinator will be appointed by the Applicant to implement, manage and develop the Detailed CTMP(s) at the appropriate time/ stage. The Detailed CTMP(s) will include the following information:

- a. Specifics of carriageway widening or improvement works;
- b. Specifics of the design of TTM measures;
- c. Details of the works to accesses, including provision of visibility splays;
- d. Further details in respect of the design and management measures required to accommodate AILs; and
- e. Information on sanctions for breaches of the routing strategies.

- 7.6.2 The Transport/ Travel Plan Co-ordinator will:

- a. Liaise proactively as appropriate with local transport and traffic groups, local planning authorities, LHAs, the police, Parish Councils, the public, and the emergency services. The Transport/ Travel Plan Co-ordinator will be responsible for recording and collating any complaints related to transport aspects of construction activities;
- b. Monitor the CTMP to identify what is working well and what can be improved;
- c. Promote the CTMP to all staff and contractors travelling to and from the Site to ensure compliance with its contents;
- d. Monitor data relating to HGV routes, timing of HGV and LGV arrivals and departures, how contractors are utilising the DMS and the emission standards of vehicles;
- e. Manage the external shuttle service between local worker accommodation and the Principal Site;
- f. Monitor data relating to levels of staff vehicles using each car park and introduce measures to ensure that it remains below the established caps;
- g. Monitor data on road safety, including collisions and near misses, liaise with the LHAs and introduce measures to manage road safety risk where appropriate;
- h. Manage the Car Share Scheme;

- i. Assign staff to the most appropriate staff car park including the provision of a car parking permit system; and
- j. Discuss issues which come to light with the relevant parties and discuss any amendments required to ensure that compliance with the CTMP is maintained.

7.7 Monitoring and Review

HGVs

- 7.7.1 To ensure that contractors are complying with the CTMP, a monitoring and review approach will be taken. This will be led by the Transport/ Travel Plan Co-ordinator.
- 7.7.2 The Transport/ Travel Plan Co-ordinator will monitor data relating to the routes utilised, the timings of arrivals and departures, how contractors are utilising the DMS, the emission standards of vehicles accessing the Site, road safety, including collisions and near misses, and reports from external parties including the public. Reporting will be on a monthly basis initially, however, the frequency of reporting will be reviewed as construction progresses and may be reduced once the peak construction period has passed. The reporting will set out the results of the data monitoring and identify any issues that need to be resolved and what measures would need to be implemented to ensure that any identified issues do not occur again.

Staff

- 7.7.3 The Car Share Scheme will be managed by the Transport/ Travel Plan Co-ordinator to implement and identify potential matches for car sharers. This will also be available to staff so that they can find their own matches. The Transport/ Travel Plan Co-ordinator will require the starting location of staff before commencing work on-site, to assist in promoting the Car Share Scheme. This takes into consideration if staff are starting their journey from a different location to their home.
- 7.7.4 The construction staff car parks will be monitored during the arrival of staff in the morning and departure of staff in the evening. The car parking areas will be managed to ensure the efficient arrival of staff and assignment of car parking spaces, where vehicles will be routed to the most appropriate location based on their arrival time. The car parking management will ensure staff entering the car parking areas park in a timely and safe manner. Given the working patterns identified it is not expected there will be the requirements for car parking management outside of the hours of 06:00-07:00 and 19:00-20:00.
- 7.7.5 The Applicant proposes to introduce a cap on vehicle numbers using each of the staff car parks in line with the peak number of staff vehicles forecast in the TA (**Appendix 16-2** of the ES [EN010142/APP/6.2]), to provide a level of control and to ensure the measures are effective.
- 7.7.6 Monitoring will be undertaken by way of In/Out counts at the car park accesses. The exact method will be determined by the contractor. As a minimum, data will be collected on a weekly basis, although it is likely that it will be collected continuously using automated technology. The Transport/

Travel Plan Co-ordinator will monitor data against the construction programme and take early action to introduce measures if vehicle numbers are forecast to exceed the cap.

- 7.7.7 The Applicant is committed to regular and frequent monitoring on a monthly basis, or such lesser frequency as is agreed with the LHAs. Monitoring will include collecting the following information and providing it to the LHAs:
- a. Freight movement to/ from the Scheme;
 - b. Details of non-compliance with routing or speed limits;
 - c. Near misses or safety related incidents;
 - d. Freight compliance with appropriate exhaust emissions (Euro VI);
 - e. Transport of AILs to/ from the Scheme;
 - f. LGV movements to/ from the Scheme;
 - g. Staff movement to/ from the Scheme, based on total numbers of vehicles and compliance with shift patterns; and
 - h. Information on complaints received on transport related issues including parking.

8. Compliance and Enforcement

8.1 Introduction

- 8.1.1 This section of the Framework CTMP provides a summary of the mechanisms that will ensure compliance with the Detailed CTMP(s).

8.2 Compliance

- 8.2.1 There are three areas under which enforcement of the CTMP will be imposed: Best Practice, Contractual Conditions and Default Mechanisms.

8.3 Best Practice

- 8.3.1 The Applicant will use internal management procedures to ensure compliance with the requirements of the CTMP, including:
- a. Contractor Kick off meetings: Contractors will be reminded of the Applicant's standards and expectations as set out in contract documentation.
 - b. Site induction: Driver induction to include briefing on aims and objectives of the CTMP, including booking system, designated routes and driver behaviour. A copy of the CTMP will be provided to each of the companies who provide services to the Scheme so that all are informed of how the Site is being managed and what the Applicant expects all contractors to adhere to.
 - c. Reporting: Incidences of non-compliance with the CTMP will be investigated. Reports from each incident will be raised and shared with the relevant contractor. Where appropriate updates to the CTMP will be

considered, in accordance with the provisions of the DCO, to resolve the risk of repeated breaches.

8.4 Contractual Conditions

- 8.4.1 Upon appointment, each contractor will be provided with a contract setting out their contractual requirements in terms of compliance with the Framework and/ or Detailed CTMP(s).
- 8.4.2 A copy of the CTMP will be provided along with confirmation of the routes vehicles are required to take to reach the Site from their starting location as well as the access which they will use and the time of entry, in order to ensure HGVs acknowledge that this route is to be followed.

8.5 Information Packs and Communications

- 8.5.1 Information packs will be provided to all contractors once they have been confirmed. The information pack will form part of the agreement between the Applicant and the designated contractors. The information pack will include details of the following:
 - a. Code of Good Practice;
 - b. Details of the Transport/ Travel Plan Co-ordinator;
 - c. Delivery routing restrictions;
 - d. Worker routing;
 - e. Emergency procedures;
 - f. Non-compliance guidance; and
 - g. Complaint procedures.

8.6 Enforcement

- 8.6.1 If despite the careful efforts of the Applicant and its contractor, there are breaches of the movement arrangements as set out in this CTMP during the construction phase, the enforcement procedures are as follows.
 - a. The Transport/ Travel Plan Co-ordinator will notify the Applicant of a breach of the CTMP arrangements as and when they occur;
 - b. The Applicant will issue a warning letter to the relevant contractor outlining what action would be taken in the event of a further breach. Details relating to the action which would be taken will be provided within the Detailed CTMP(s);
 - c. The Applicant will report the details of the response to the Transport/ Travel Plan Co-ordinator as part of the monitoring report. The monitoring report will be made available to the relevant local planning authorities and relevant LHAs at their request to ensure compliance and that action is being taken where breaches are occurring.
- 8.6.2 Mechanisms will be established to provide all parties with an understanding of the enforcement procedures to be applied and further detail on the

sanctions which could be applied would be included within the Detailed CTMP(s).

9. Conclusion

- 9.1.1 The purpose of this Framework CTMP is to focus on the management of construction traffic along the local highway network within the vicinity of the Scheme during the construction period of the works, in order to limit any potential disruptions and implications on the wider transport network. The **Framework P_{Ro}W Management Plan [EN010142/APP/7.16]** identifies P_{Ro}W to be potentially affected by the proposals and sets out measures to mitigate any impacts.
- 9.1.2 This Framework CTMP sets out the proposals to manage construction traffic and staff vehicles during the construction of the Scheme. It identifies the management of freight traffic (HGVs), as well as LGVs and construction staff vehicles.
- 9.1.3 It should be noted that as this is a framework document, certain details will remain to be developed as the Scheme progresses into detailed design stage. The full details of all measures may not be available until after consent for the Scheme has been granted and will be provided within the Detailed CTMP(s) as necessary.

10. References

- Ref. 1 Construction Logistics and Community Safety (CLOCS). www.clocs.org.uk [accessed 22nd March 2024]
- Ref 2 Road Vehicle (Authorisation of Special Types) Order 2003. www.legislation.gov.uk [Accessed 18 March 2023]
- Ref 3 Highways England. Design Manual for Roads and Bridges (DMRB) GG119 Road Safety Audit. Highways England. London

Appendix A Indicative Scheme Access Plans

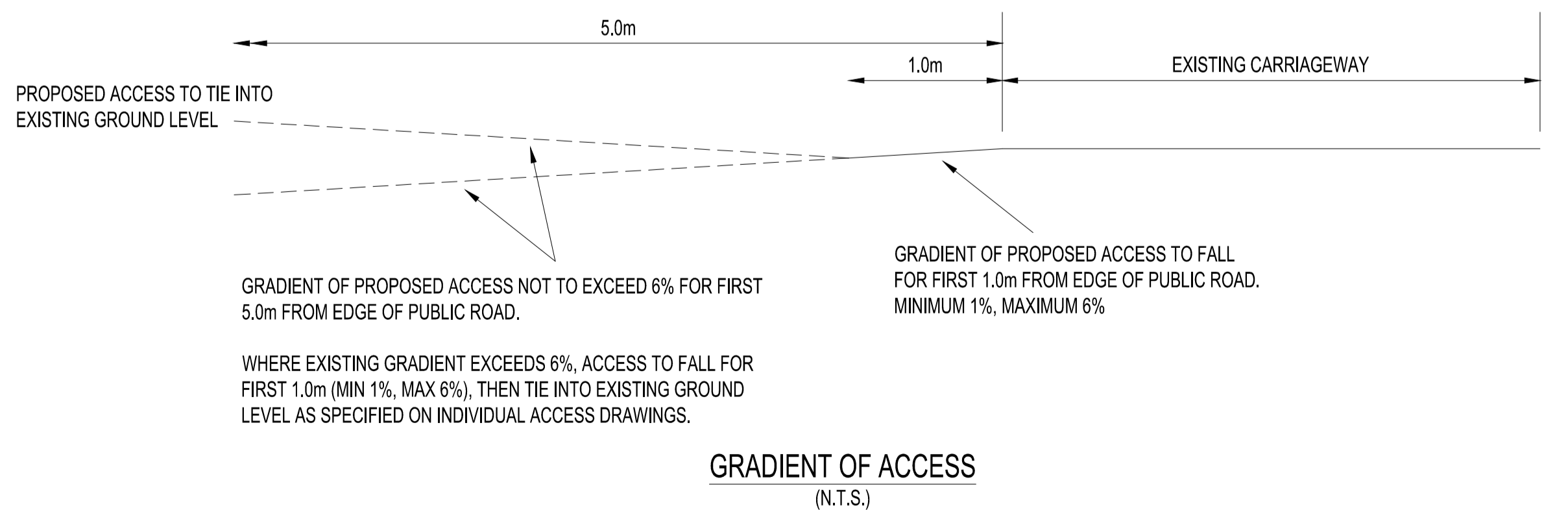
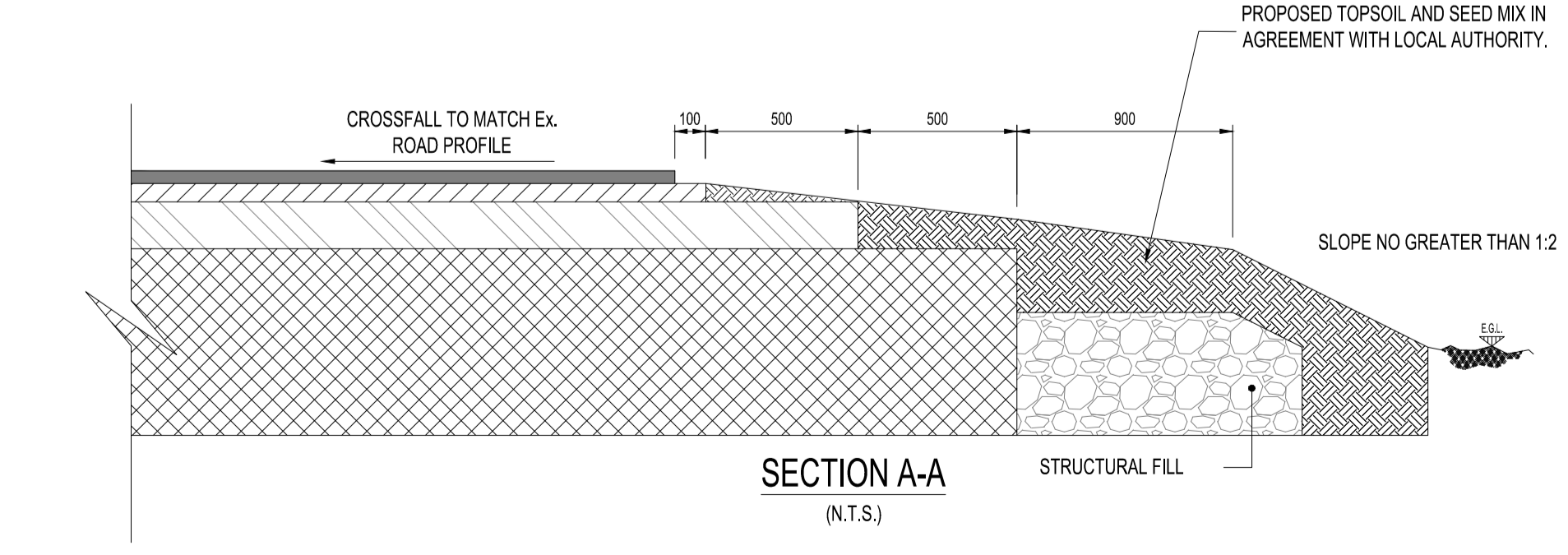
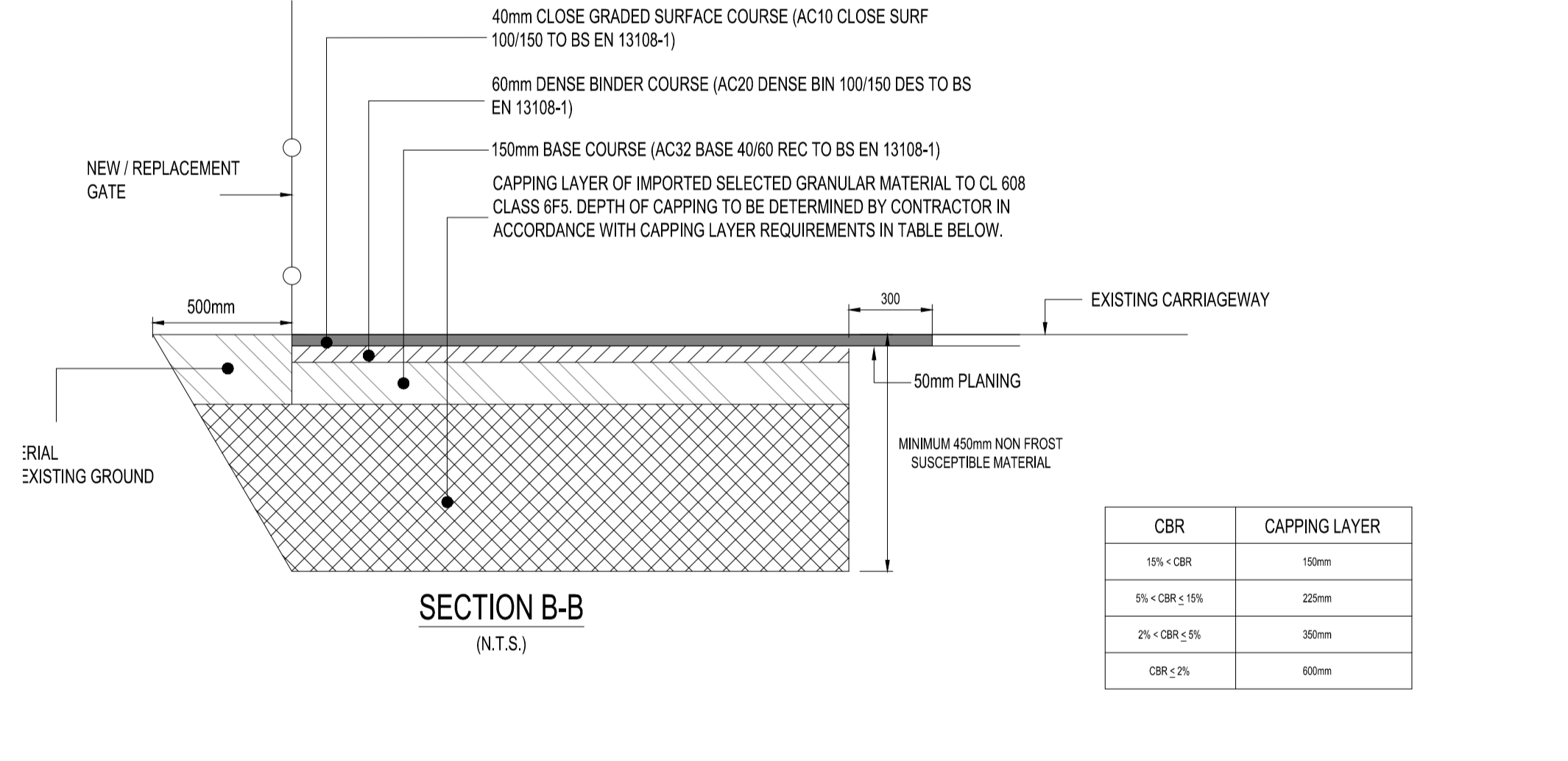
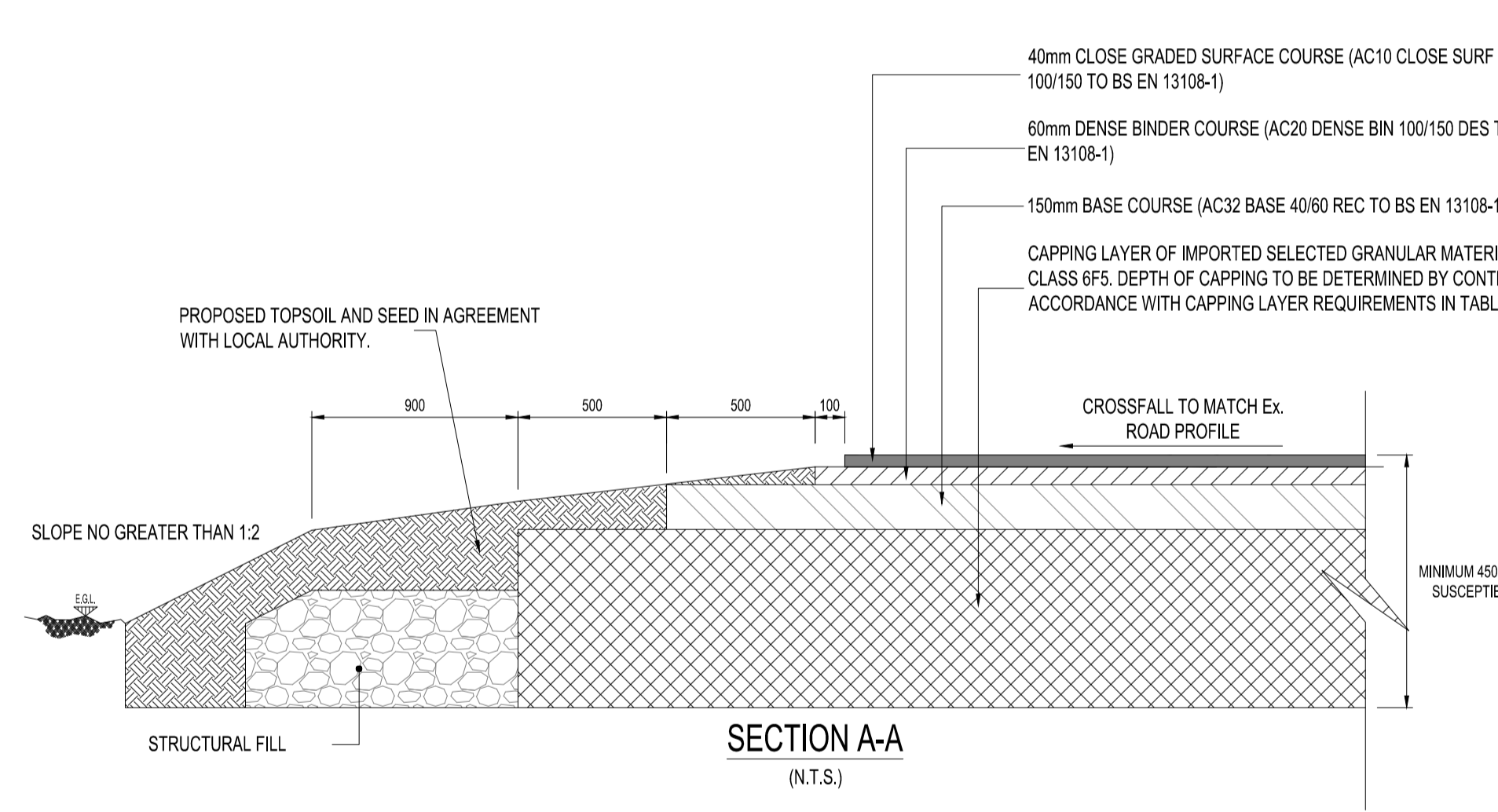
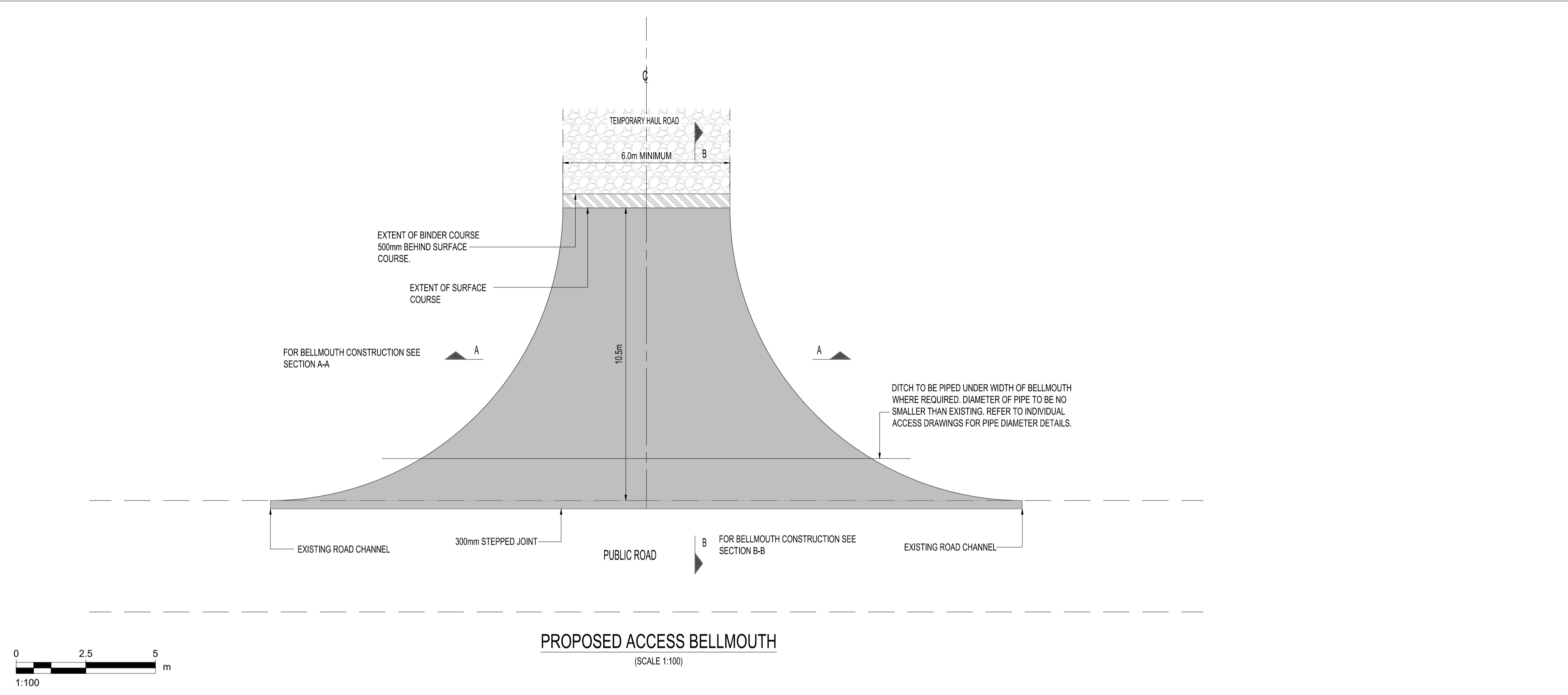

ISSUE/REVISION

Rev	Date	Description	Dim/Chk/Appr
-	17.08.23	FIRST ISSUE	GM&E/JM&GJY

Key Plan

Purpose Of Issue
DCO SUBMISSION

Project Number
60682158

Sheet Title
PROPOSED BELLMOUTH ACCESS TYPICAL ARRANGEMENT

Sheet Number
60682158-ACM-XX-00-DR-CE-1021

Scale: As shown @ A1 **Rev:** .

NOT FOR CONSTRUCTION
FOR INFORMATION ONLY

This drawing has been prepared for the use of AECOM's client. It may not be used, modified, reproduced or relied upon by third parties, except as agreed by AECOM or as required by law. AECOM accepts no responsibility, and denies any liability whatsoever, to any party that uses or relies on this drawing without AECOM's express written consent. Do not scale this document. All measurements must be obtained from the stated dimensions.

KEY:

- DCO SUBMISSION ORDER LIMITS
- EXISTING FENCE
- EXISTING VEHICLE GATE
- EXISTING TREES
- EXISTING HEDGEROW / VEGETATION
- VISIBILITY SPLAY
- EXISTING BELLMOUTH TO BE RESURFACED
- PROPOSED CARRIAGEWAY RESURFACING

ISSUE/REVISION

Rev	Date	Description	Dwn/Chk/Appr
C	15.03.24	FINALISED FOR DCO SUBMISSION.	GM&E/PCGY
B	06.12.23	FINALISED FOR DISCUSSION WITH LHA.	GM&E/JMCGY
A	08.09.23	VISIBILITY X DISTANCE AMENDED	GM&E/EEP
-	23.08.23	FIRST ISSUE	MM/GM&E/EEP

NOT FOR CONSTRUCTION
FOR INFORMATION ONLY

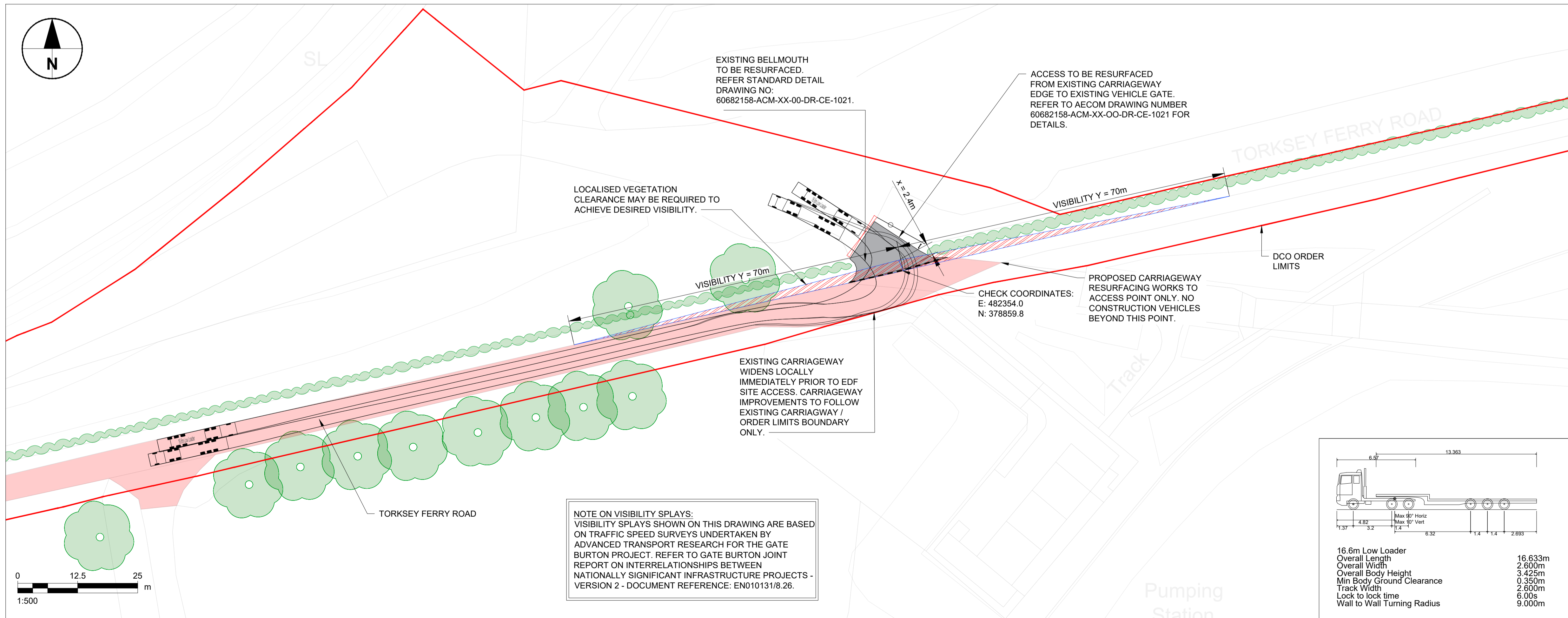
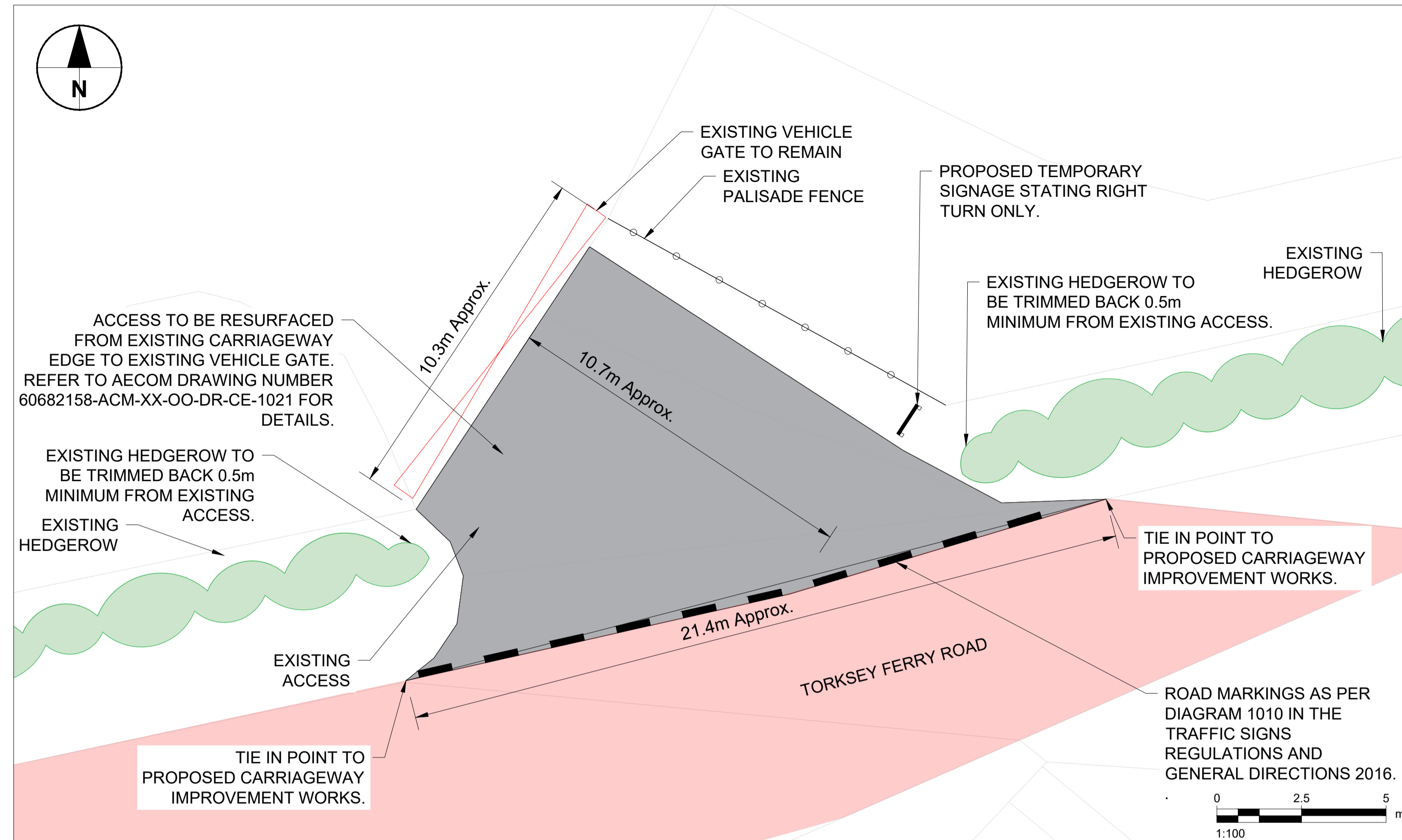
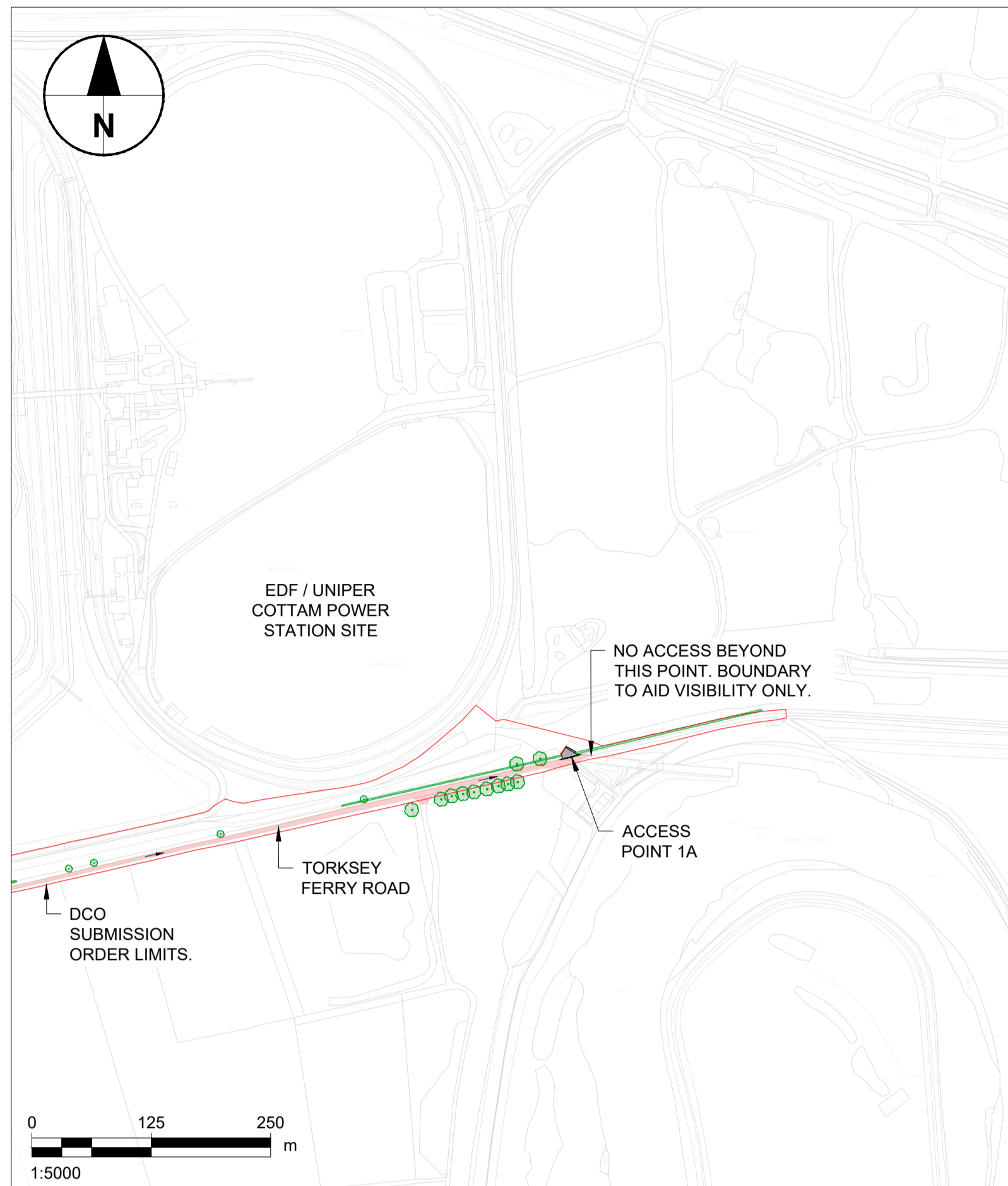

NOTE ON VISIBILITY SPLAYS:
 VISIBILITY SPLAYS SHOWN ON THIS DRAWING ARE BASED ON TRAFFIC SPEED SURVEYS UNDERTAKEN BY ADVANCED TRANSPORT RESEARCH FOR THE GATE BURTON PROJECT. REFER TO GATE BURTON JOINT REPORT ON INTERRELATIONSHIPS BETWEEN NATIONALLY SIGNIFICANT INFRASTRUCTURE PROJECTS - VERSION 2 - DOCUMENT REFERENCE: EN010131/8.26.

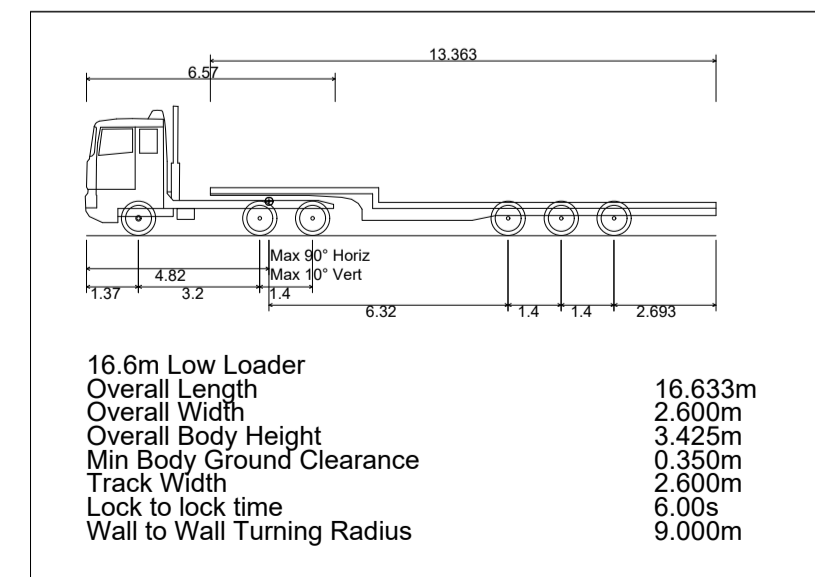

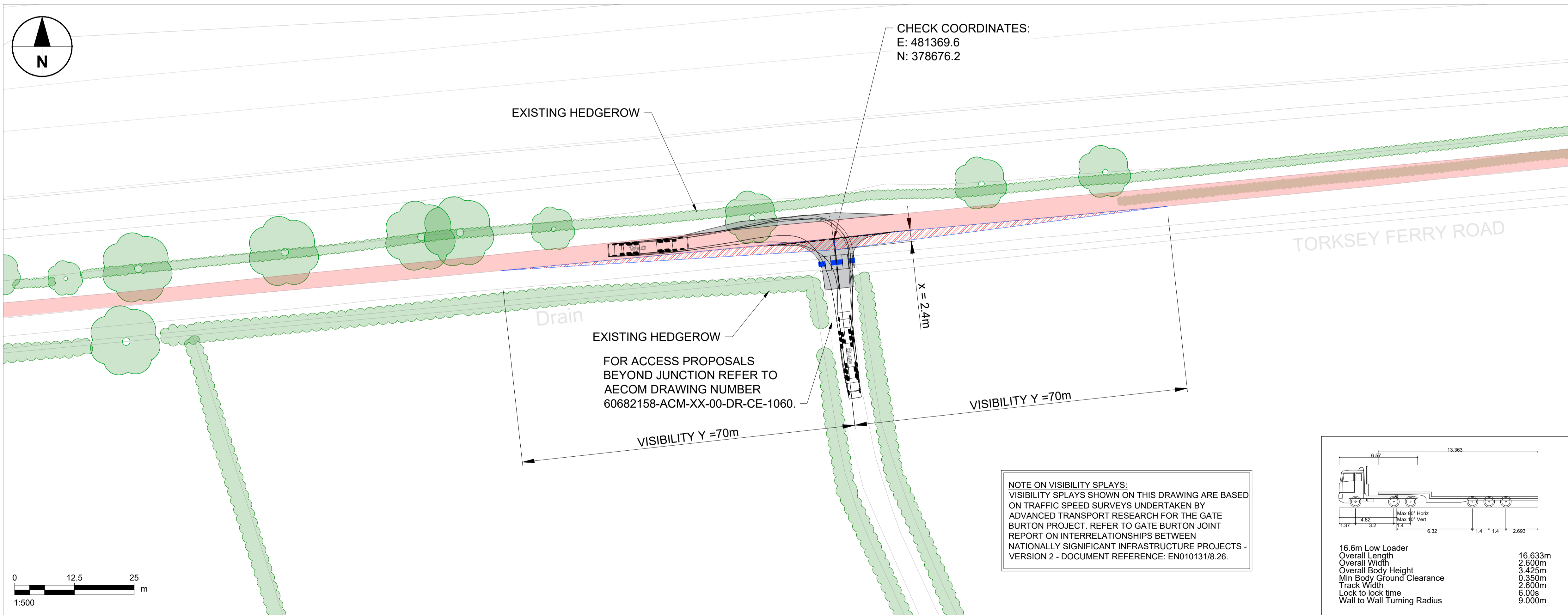
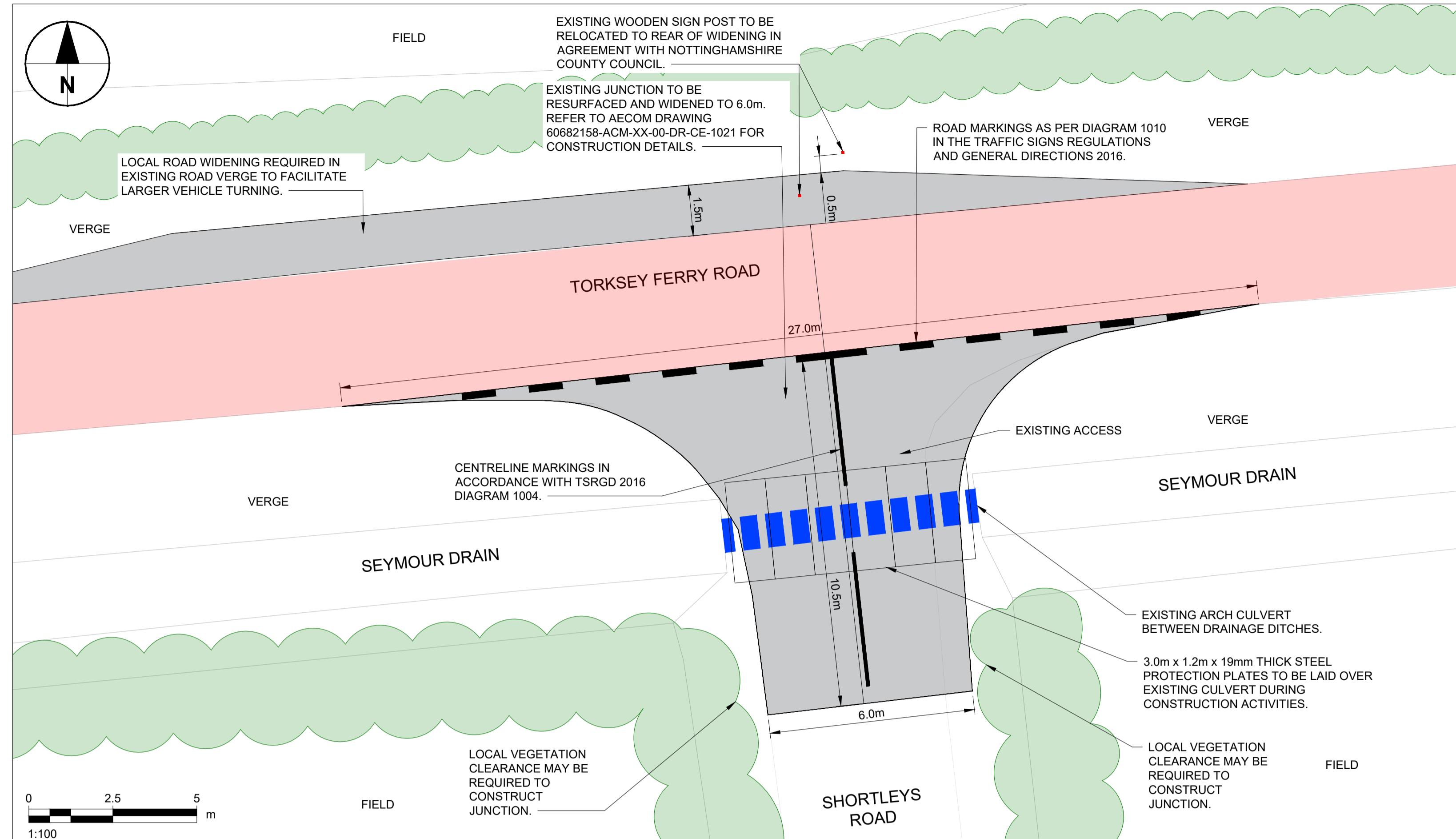
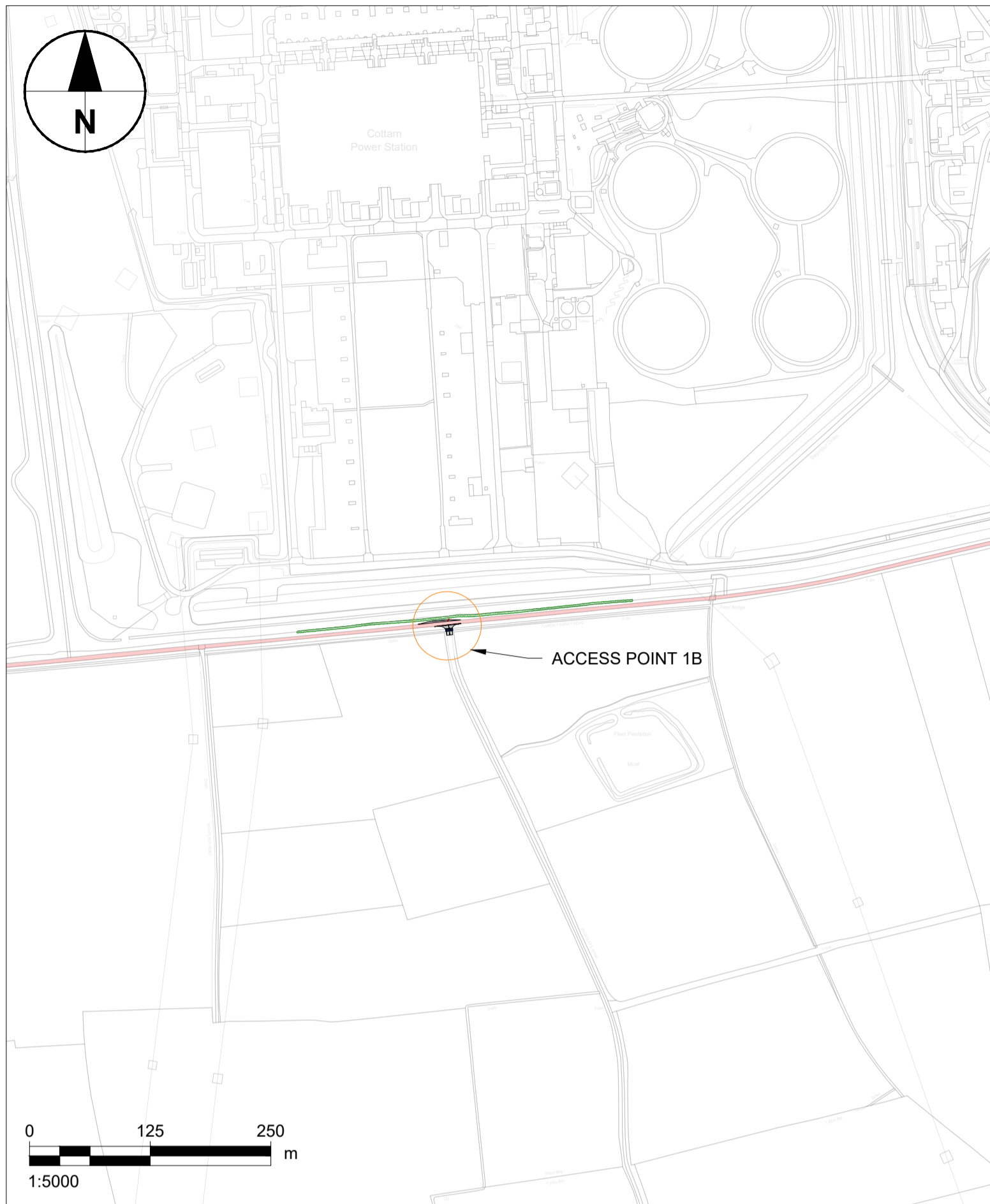

- Notes**
- ALL DIMENSIONS IN METRES UNLESS STATED OTHERWISE.
 - DO NOT SCALE FROM THIS DRAWING USE ONLY FIGURED DIMENSIONS.
 - VISIBILITY X DISTANCE IS BASED ON 2.4m WHICH IS A PERMITTED RELAXATION IN ACCORDANCE WITH CD123 DOCUMENTATION SUBJECT TO APPROVAL BY NOTTINGHAM COUNTY COUNCIL.

KEY:

- DCO SUBMISSION ORDER LIMITS
- EXISTING TREES
- EXISTING HEDGEROW / VEGETATION
- VISIBILITY SPLAY
- EXISTING BELLMOUTH TO BE RESURFACED AND WIDENED
- PROPOSED CARRIAGEWAY RESURFACING REFER TO AECOM DRAWING 1050 FOR DETAILS.

ISSUE/REVISION

Rev	Date	Description	Dm/Chk/Appr
B	15.03.24	FINALISED FOR DCO SUBMISSION.	GM/EP/ICGY
A	01.12.23	FINALISED FOR DISCUSSION WITH LHA.	GM/EP/MCCGY
-	18.09.23	FIRST ISSUE	MM/GM/EP

NOT FOR CONSTRUCTION
 FOR INFORMATION ONLY

Purpose Of Issue

DCO SUBMISSION

Project Number

60682158

Sheet Title

PROPOSED ACCESS POINT 1B
(SHORTLEYS ROAD)

Sheet Number

60682158-ACM-XX-00-DR-CE-1027

Scale: AS SHOWN @ A1 **Rev:** B

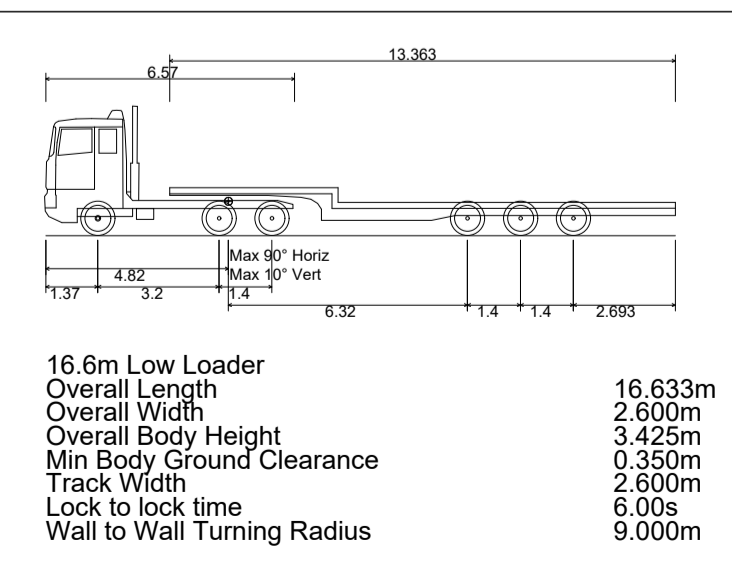

NOTE ON VISIBILITY SPLAYS:
 VISIBILITY SPLAYS SHOWN ON THIS DRAWING ARE BASED ON TRAFFIC SPEED SURVEYS UNDERTAKEN BY ADVANCED TRANSPORT RESEARCH FOR THE GATE BURTON PROJECT. REFER TO GATE BURTON JOINT REPORT ON INTERRELATIONSHIPS BETWEEN NATIONALLY SIGNIFICANT INFRASTRUCTURE PROJECTS - VERSION 2 - DOCUMENT REFERENCE: EN010131/8.26.

- Notes**
1. ALL DIMENSIONS IN METRES UNLESS STATED OTHERWISE.
 2. DO NOT SCALE FROM THIS DRAWING USE ONLY FIGURED DIMENSIONS.
 3. VISIBILITY X DISTANCE IS BASED ON 2.4m WHICH IS A PERMITTED RELAXATION IN ACCORDANCE WITH CD123 DOCUMENTATION SUBJECT TO APPROVAL BY NOTTINGHAMSHIRE COUNTY COUNCIL.

KEY:

- DCO SUBMISSION ORDER LIMITS
- EXISTING FENCE
- EXISTING TREES
- EXISTING HEDGEROW / VEGETATION
- VISIBILITY SPLAY
- PROPOSED SURFACED BELLMOUTH
- PROPOSED CARRIAGEWAY IMPROVEMENT WORKS. REFER TO AECOM DRAWING 1050 FOR DETAILS.

ISSUE/REVISION

Rev	Date	Description	Drm/Chk/Appr
C	15.03.24	FINALISED FOR DCO SUBMISSION.	GM&E/EP/CGY
B	06.12.23	FINALISED FOR DISCUSSION WITH LHA.	GM&E/JM/CGY
A	08.09.23	VISIBILITY X DISTANCE AMENDED	GM&E/EP
-	23.08.23	FIRST ISSUE	MM/GM&E/EP

NOT FOR CONSTRUCTION
FOR INFORMATION ONLY

Purpose Of Issue
 DCO SUBMISSION
Project Number
 60682158
Sheet Title
 PROPOSED ACCESS POINT 2
 (TORKSEY FERRY ROAD TO
 COTTAM ROAD)
Sheet Number
 60682158-ACM-XX-00-DR-CE-1026
Scale: AS SHOWN @ A1 **Rev:** C

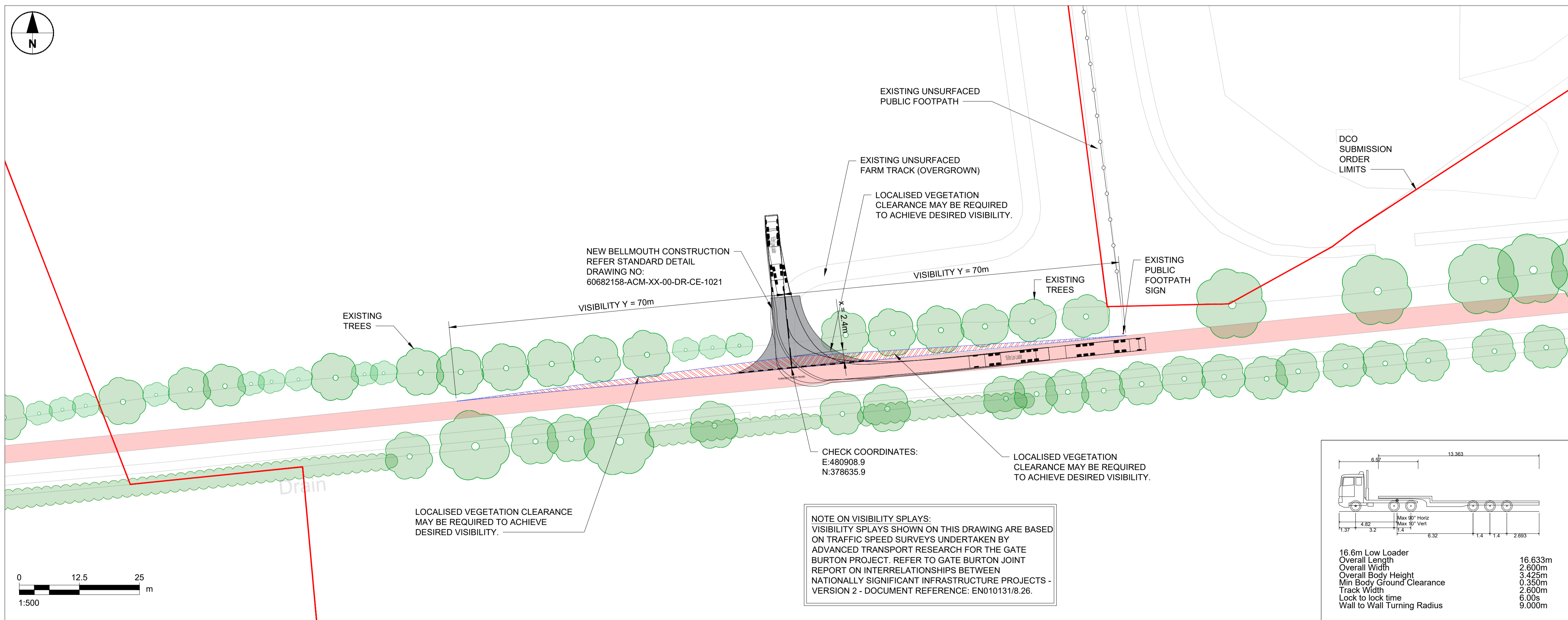
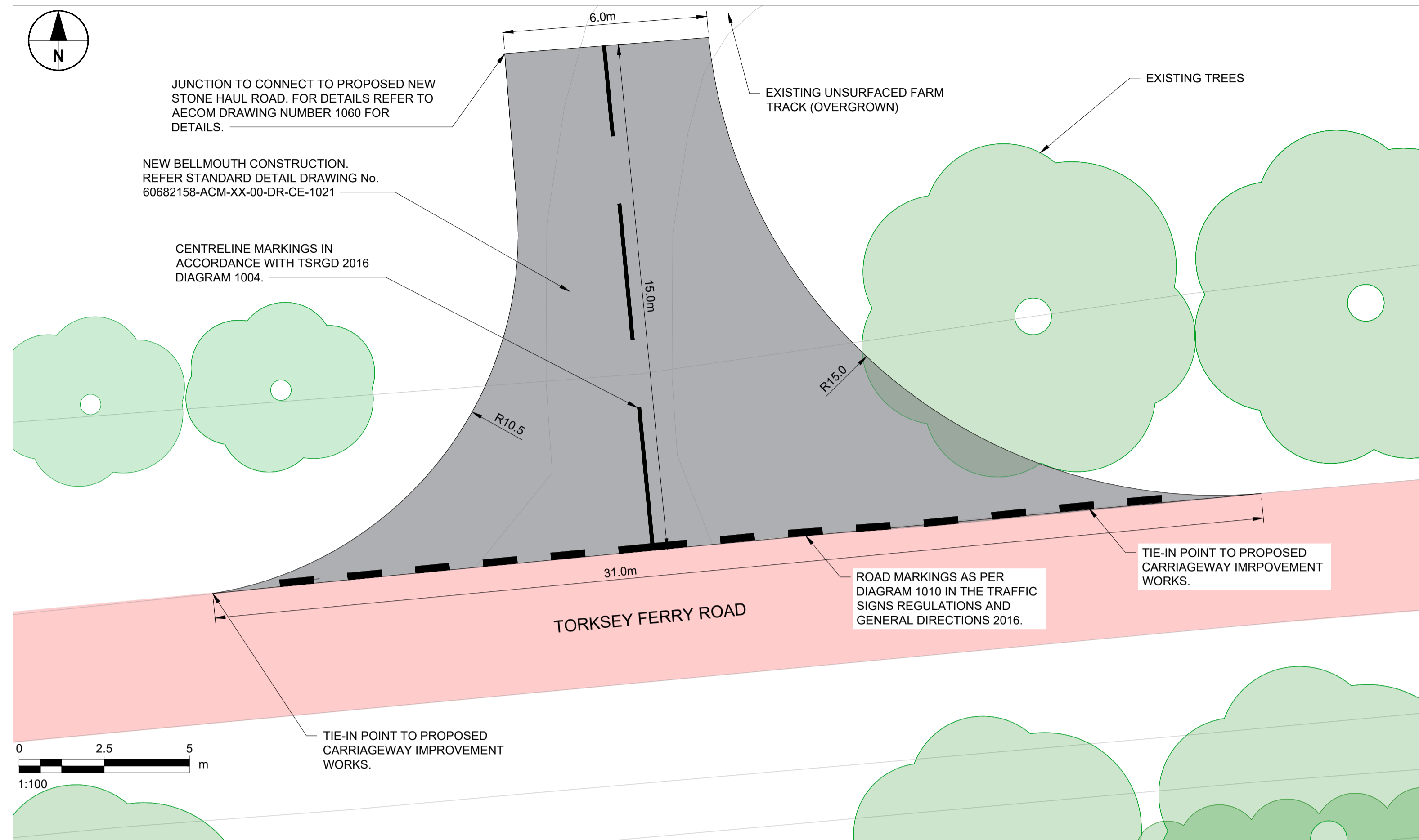
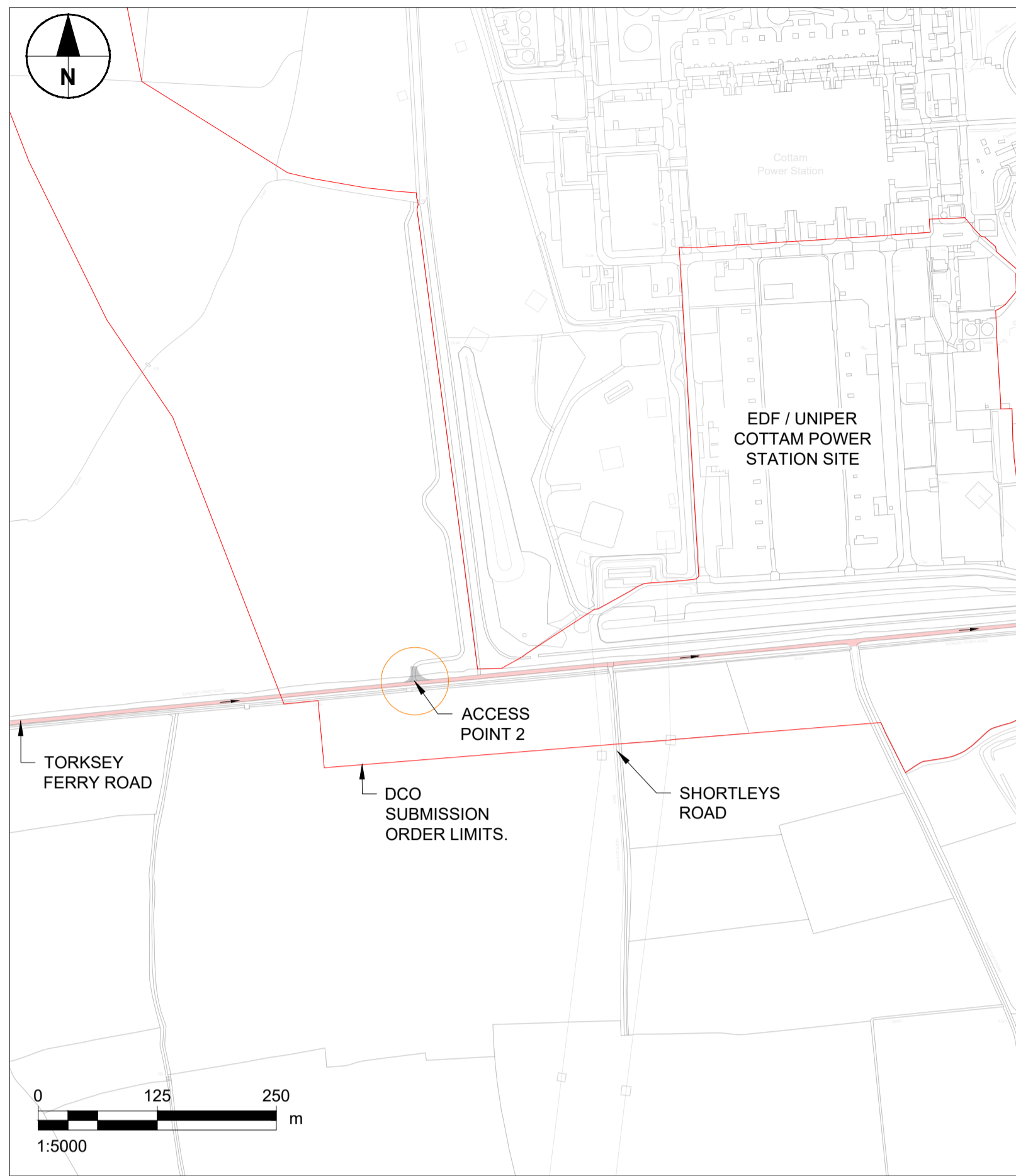

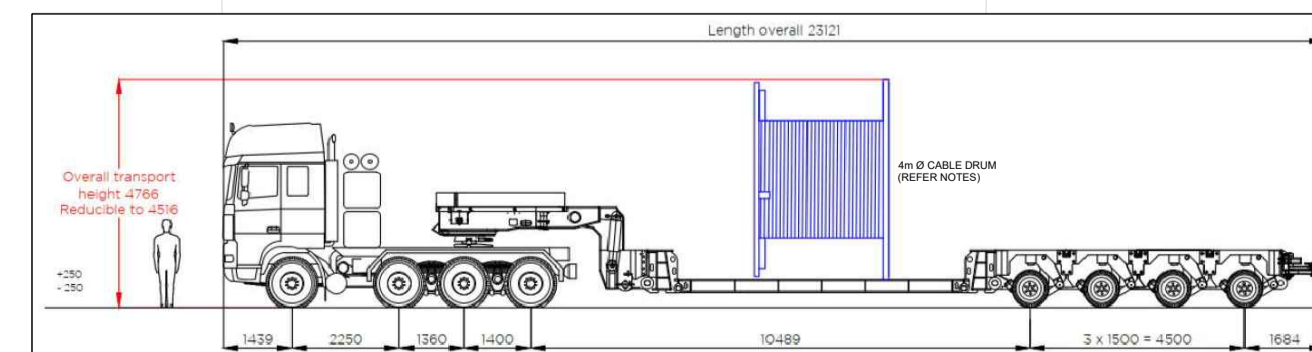
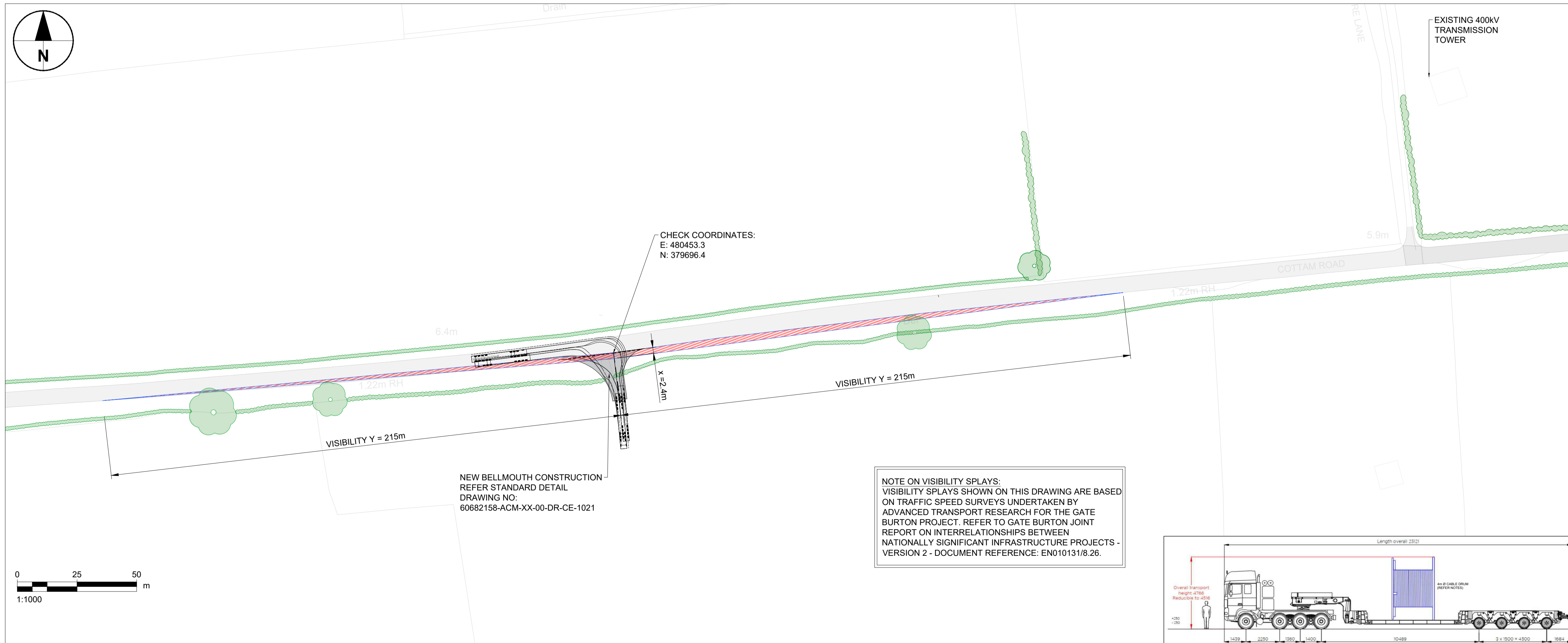
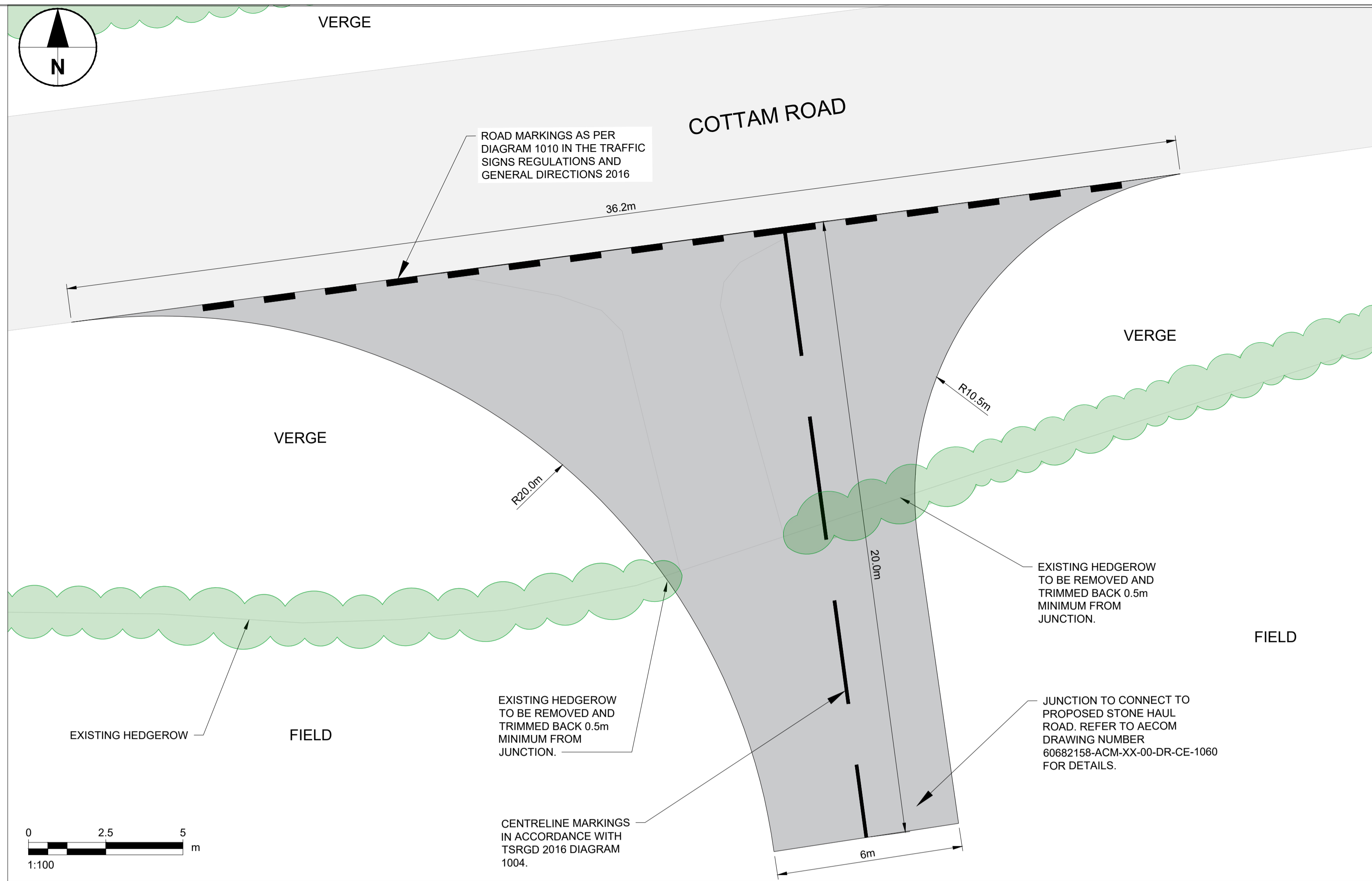
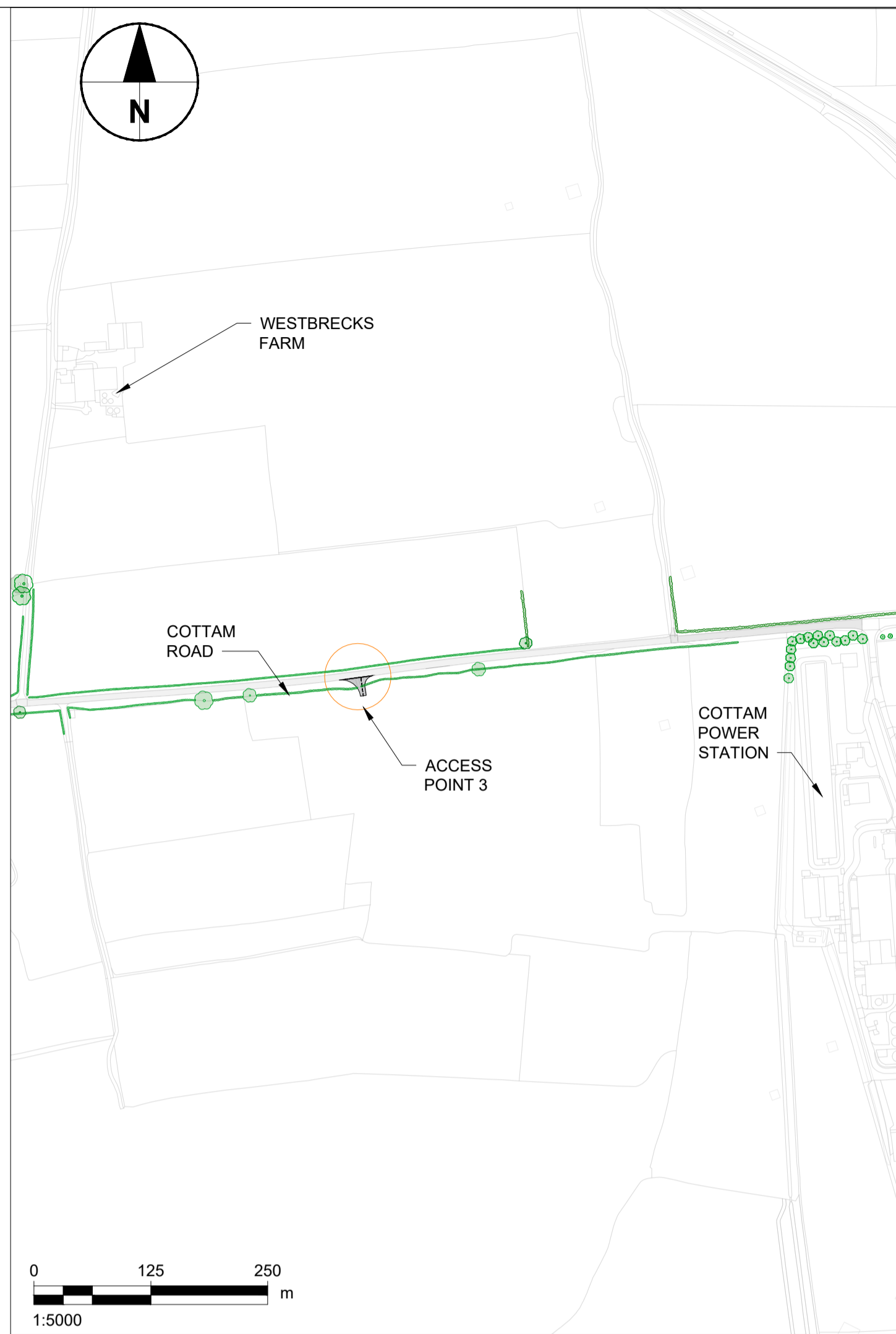

- Notes
- ALL DIMENSIONS IN METRES UNLESS STATED OTHERWISE.
 - DO NOT SCALE FROM THIS DRAWING USE ONLY FIGURED DIMENSIONS.
 - VISIBILITY X DISTANCE IS BASED ON 2.4m WHICH IS A PERMITTED RELAXATION IN ACCORDANCE WITH CD123 DOCUMENTATION SUBJECT TO APPROVAL BY NOTTINGHAMSHIRE COUNTY COUNCIL.

KEY:

- DCO SUBMISSION ORDER LIMITS
- EXISTING TREES
- EXISTING HEDGEROW / VEGETATION
- VISIBILITY SPLAY
- NEW SURFACED BELLMOUTH
- EXISTING CARRIAGEWAY

ISSUE/REVISION

Rev	Date	Description	Drm/Chk/Appr
D	15.03.24	FINALISED FOR DCO SUBMISSION.	GM&E/EP/CGY
C	02.02.24	ACCESS MOVED WEST AND VISIBILITY AMENDED.	GM&E/JM/CGY
B	06.12.23	FINALISED FOR DISCUSSION WITH LHA.	GM&E/JM/CGY
A	08.09.23	VISIBILITY X DISTANCE AMENDED.	GM&E/EP
-	23.08.23	FIRST ISSUE	MM/GM&E/EP

NOT FOR CONSTRUCTION
FOR INFORMATION ONLY

Purpose Of Issue
 DCO SUBMISSION
 Project Number
 60682158
 Sheet Title
 PROPOSED ACCESS POINT 3
 (COTTAM ROAD, SOUTHBOUND)
 Sheet Number
 60682158-ACM-XX-00-DR-CE-1028
 Scale: AS SHOWN @ A1 Rev: D

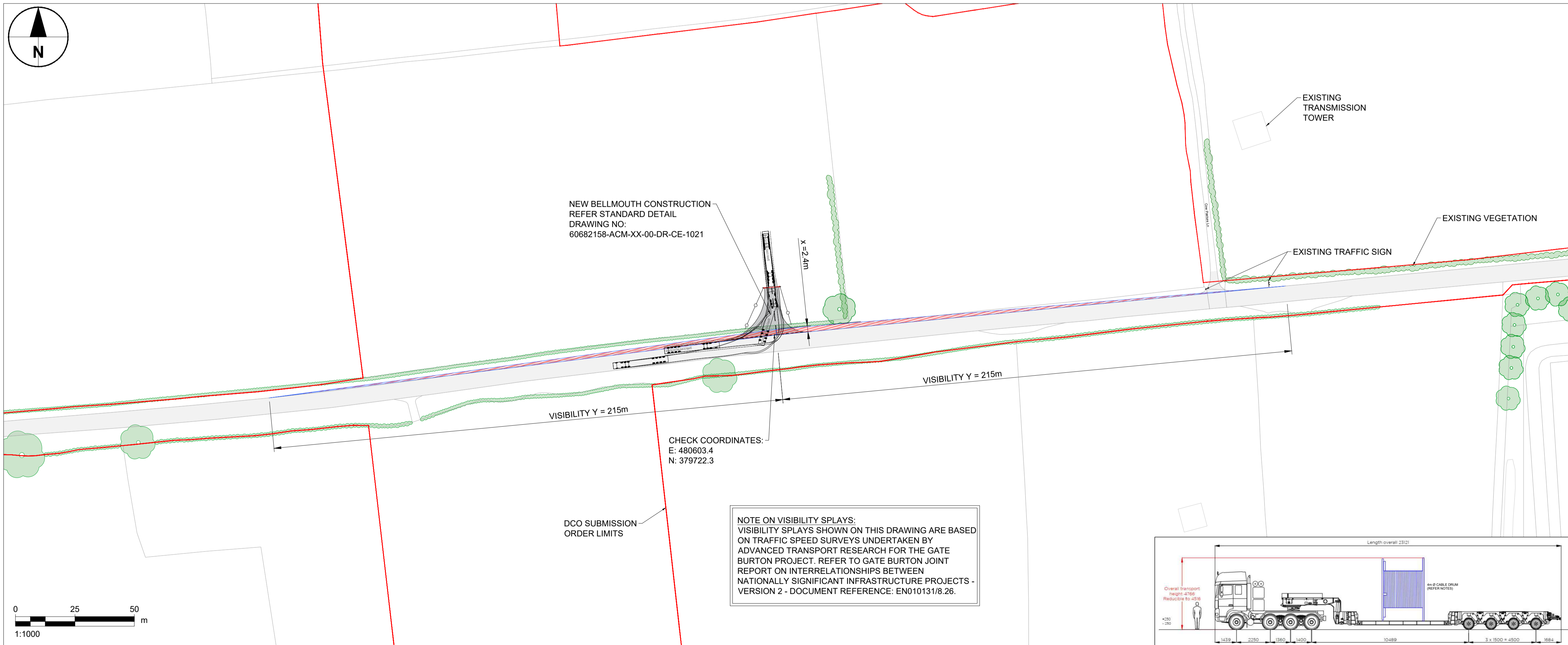
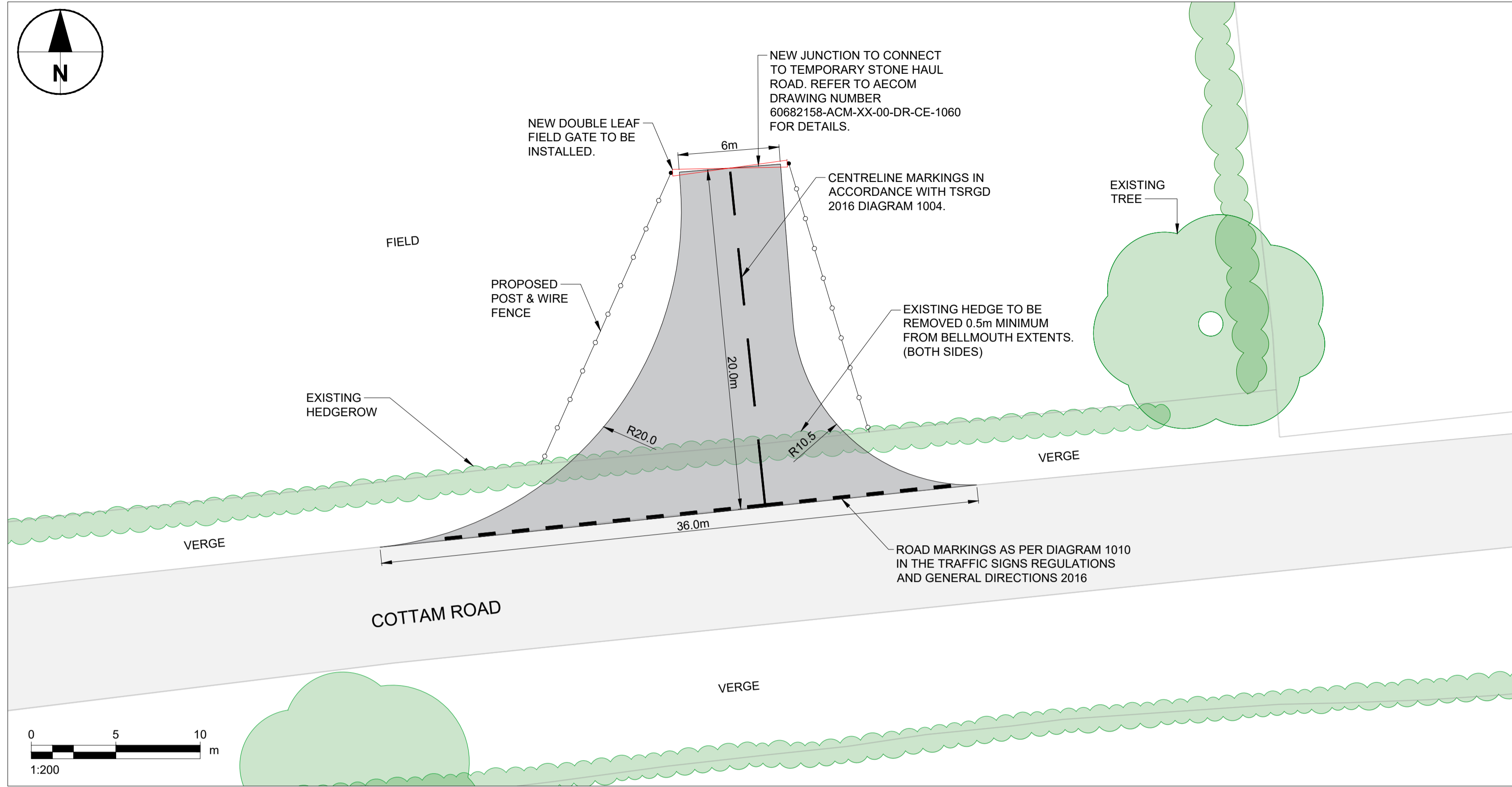
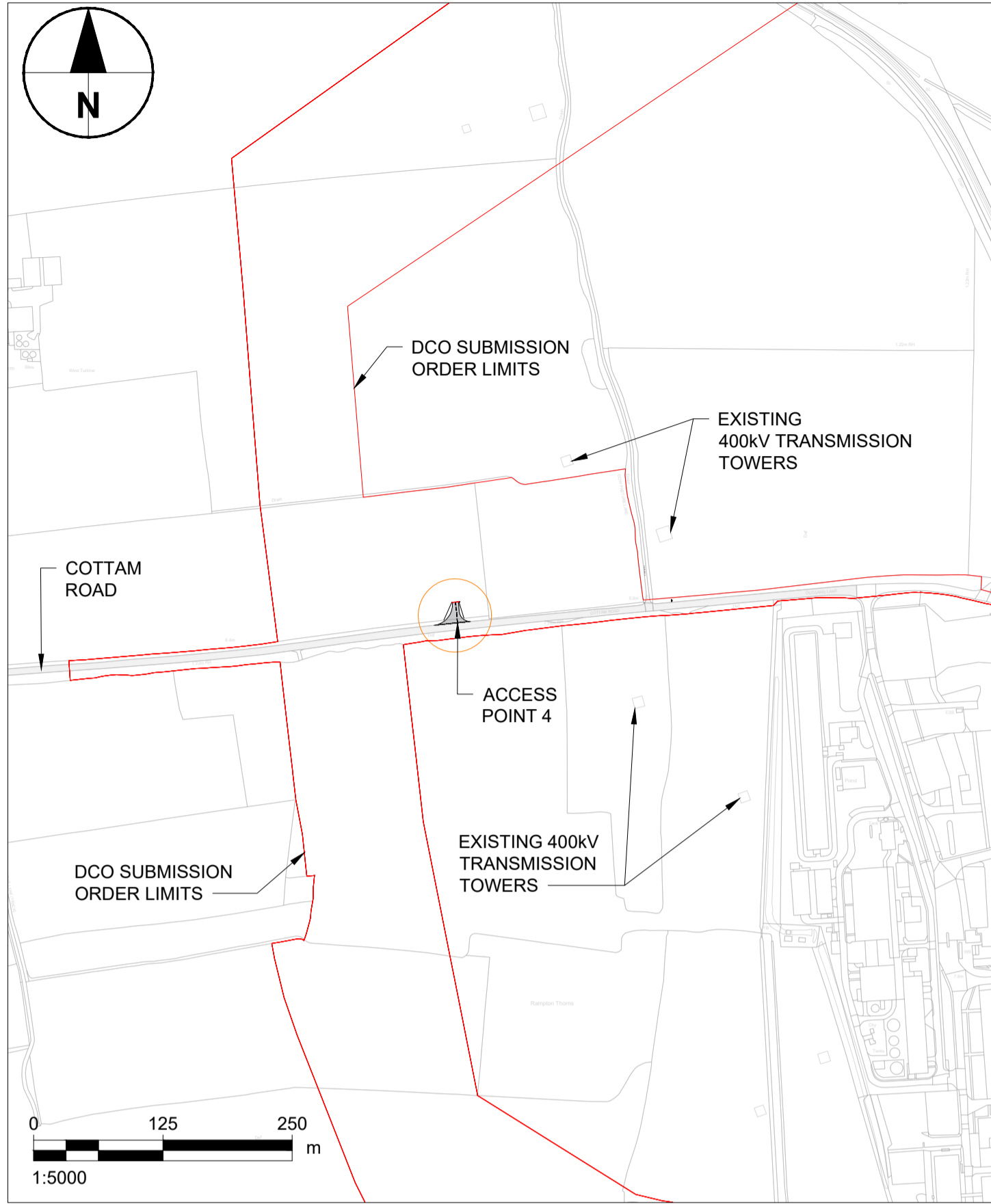

- Notes**
1. ALL DIMENSIONS IN METRES UNLESS STATED OTHERWISE.
 2. DO NOT SCALE FROM THIS DRAWING USE ONLY FIGURED DIMENSIONS.
 3. VISIBILITY X DISTANCE IS BASED ON 2.4m WHICH IS A PERMITTED RELAXATION IN ACCORDANCE WITH CD123 DOCUMENTATION SUBJECT TO APPROVAL BY NOTTINGHAMSHIRE COUNTY COUNCIL.

KEY:

- DCO SUBMISSION ORDER LIMITS
- PROPOSED P/W FENCE
- PROPOSED FIELD GATE
- EXISTING TREES
- EXISTING HEDGEROW / VEGETATION
- VISIBILITY SPLAY
- NEW SURFACED BELLMOUTH
- EXISTING CARRIAGEWAY

ISSUE/REVISION

Rev	Date	Description	Drn/Chk/Appr
D	15.03.24	FINALISED FOR DCO SUBMISSION.	GM&E/PCGY
C	02.02.24	VISIBILITY SPLAYS AMENDED.	GM&E/JMCGY
B	06.12.23	FINALISED FOR DISCUSSION WITH LHA.	GM&E/JMCGY
A	08.09.23	VISIBILITY X DISTANCE AMENDED	GM&E/EP
-	23.08.23	FIRST ISSUE	MM/GM&E/EP

NOT FOR CONSTRUCTION
FOR INFORMATION ONLY

This drawing has been prepared for the use of AECOM's client. It may not be used, modified, reproduced or relied upon by third parties, except as agreed by AECOM or as required by law. AECOM accepts no responsibility, and denies any liability, whatsoever, to any party that uses or relies on this drawing without AECOM's express written consent. Do not scale this document. All measurements must be obtained from the stated dimensions.

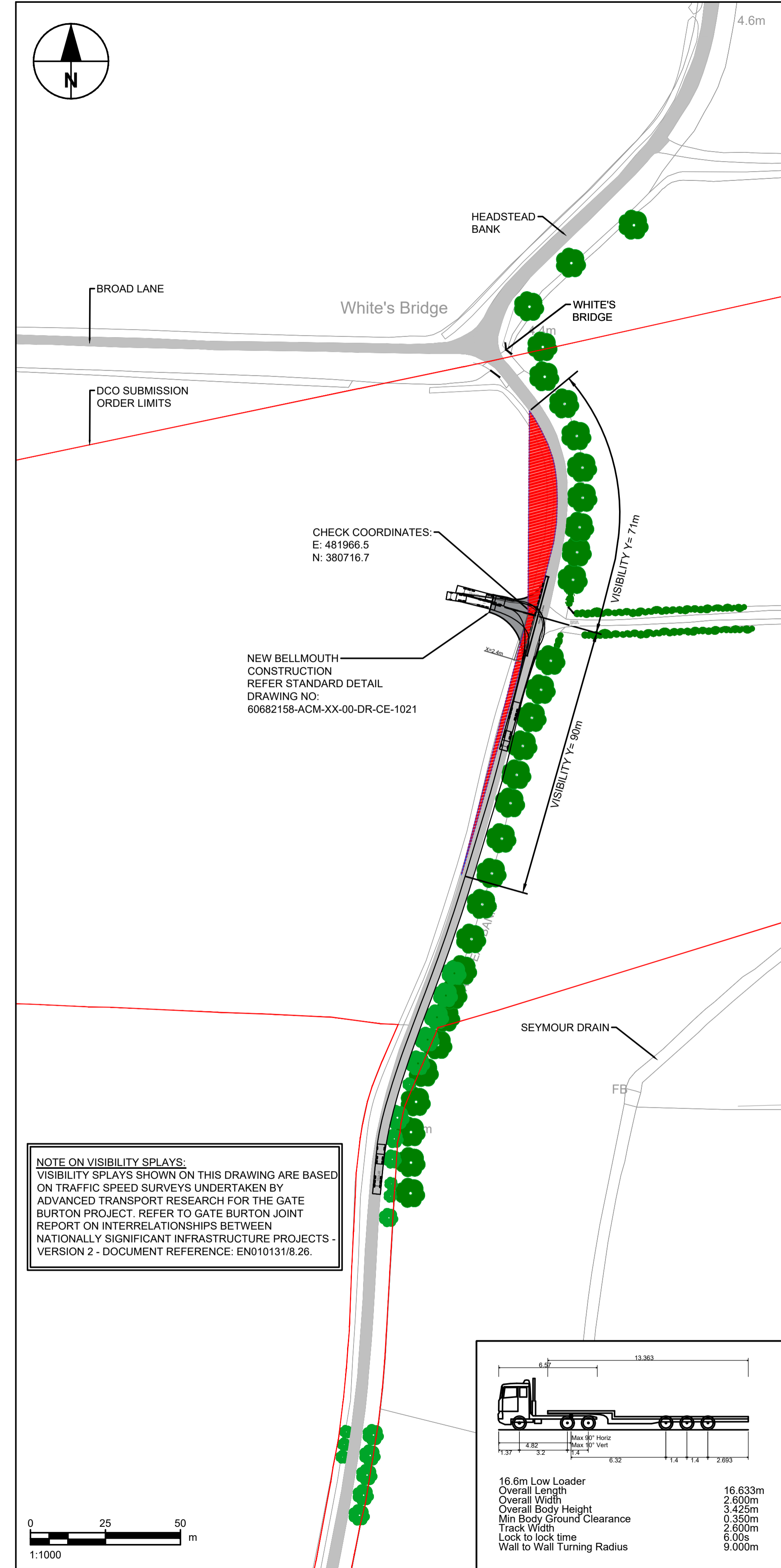
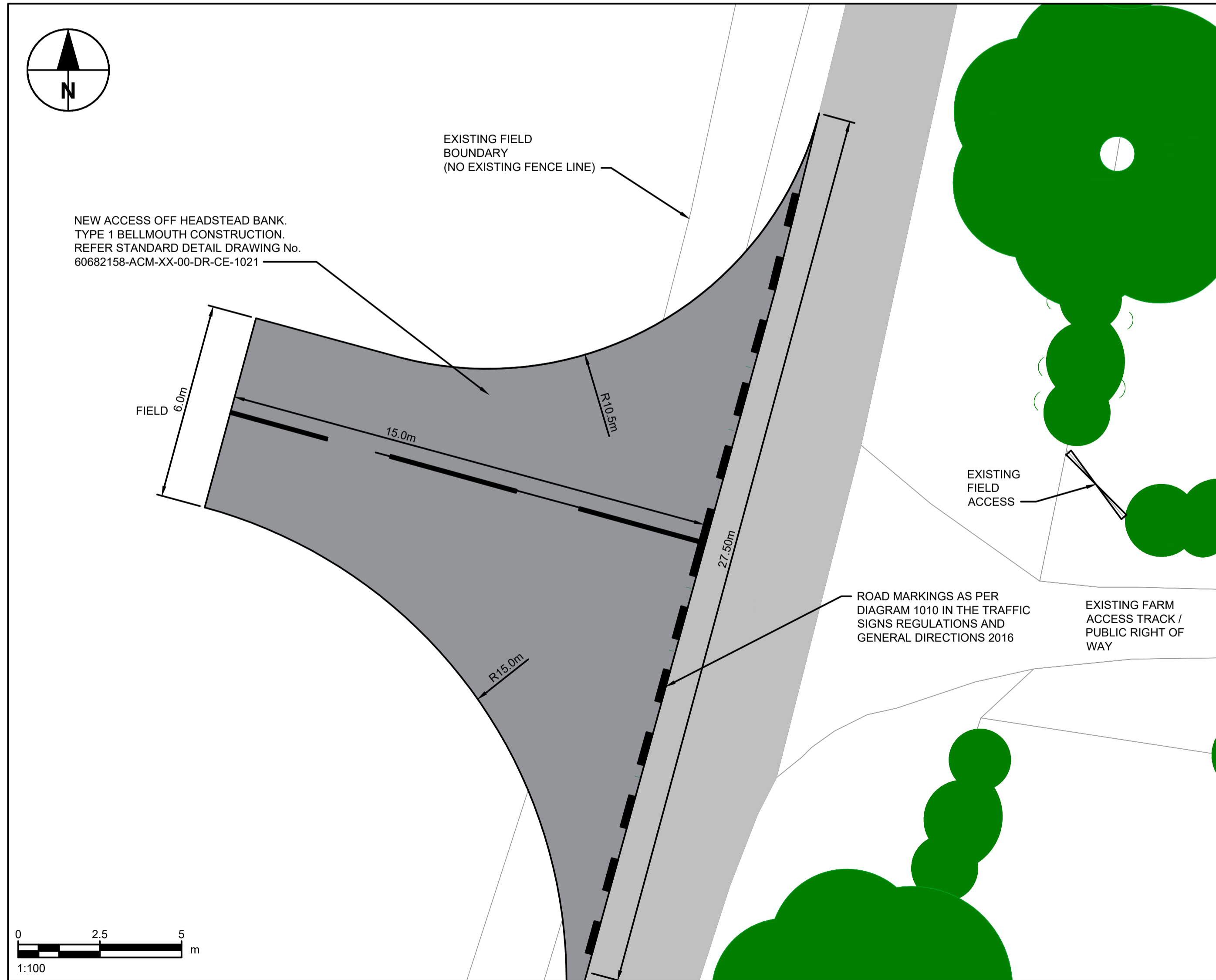
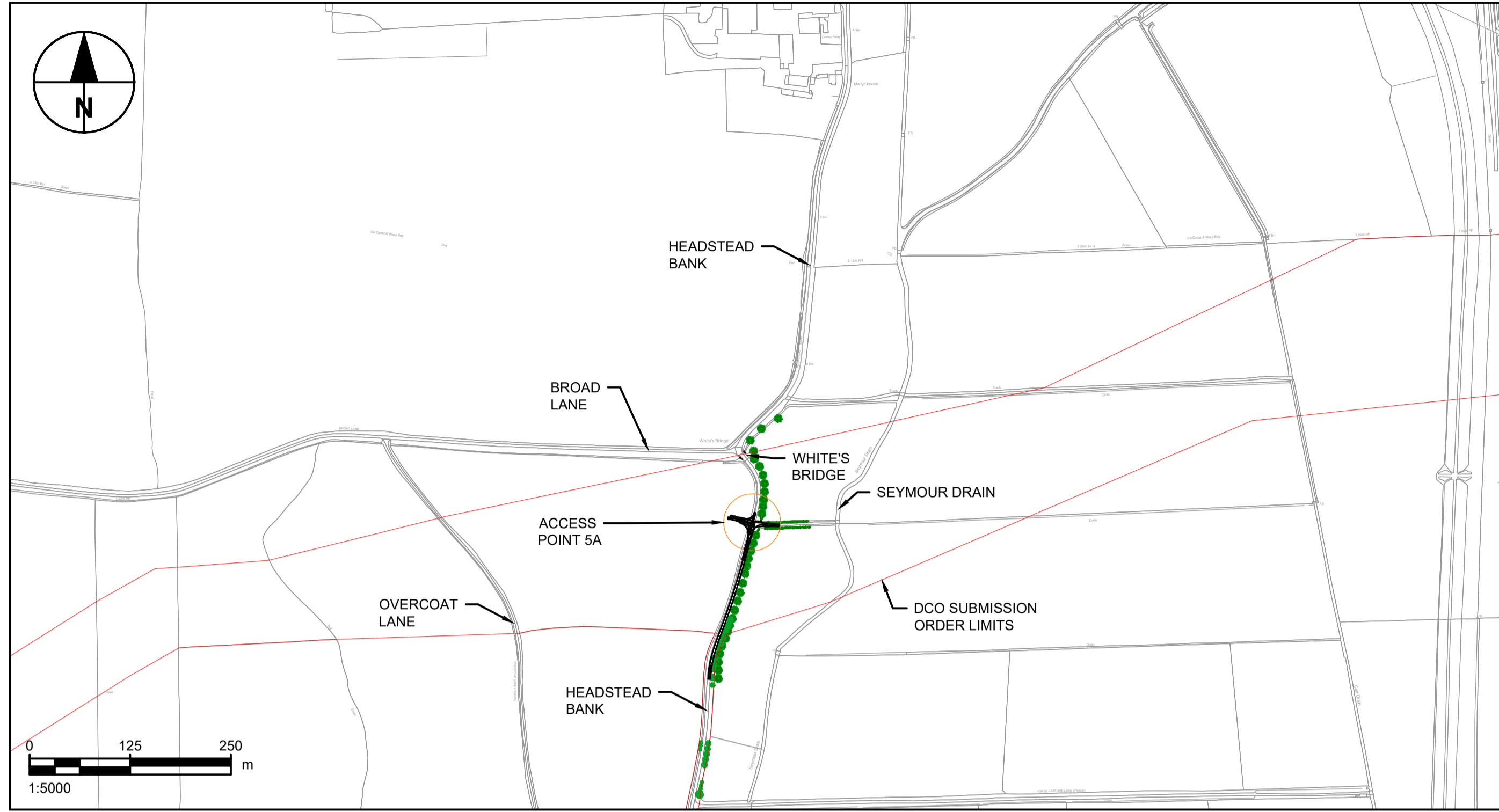

KEY:

- DCO SUBMISSION ORDER LIMITS
- EXISTING TREES
- EXISTING HEDGEROW / VEGETATION
- ▨ VISIBILITY SPLAY
- NEW SURFACED BELLMOUTH
- EXISTING CARRIAGEWAY

**NOT FOR CONSTRUCTION
FOR INFORMATION ONLY**

ISSUE/REVISION			
Rev	Date	Description	Drm/Chk/Appr
D	15.03.24	FINALISED FOR DCO SUBMISSION	GME/EP/CGY
C	02.02.24	SOUTHBOUND VISIBILITY SPLAY AMENDED	GME/JM/CGY
B	01.12.23	FINALISED FOR DISCUSSION WITH LHA	GME/JM/CGY
A	08.09.23	VISIBILITY X DISTANCE AMENDED	GMM/GME/EP
.	23.08.23	FIRST ISSUE	MMG/GME/EP

Key Plan

Purpose Of Issue

DCO SUBMISSION

Project Number

60677969

Sheet Title

PROPOSED ACCESS POINT 5A
(HEADSTEAD BANK, WESTBOUND)

Sheet Number

60682158-ACM-XX-00-DR-CE-1030

Scale: AS SHOWN @ A1 Rev: D

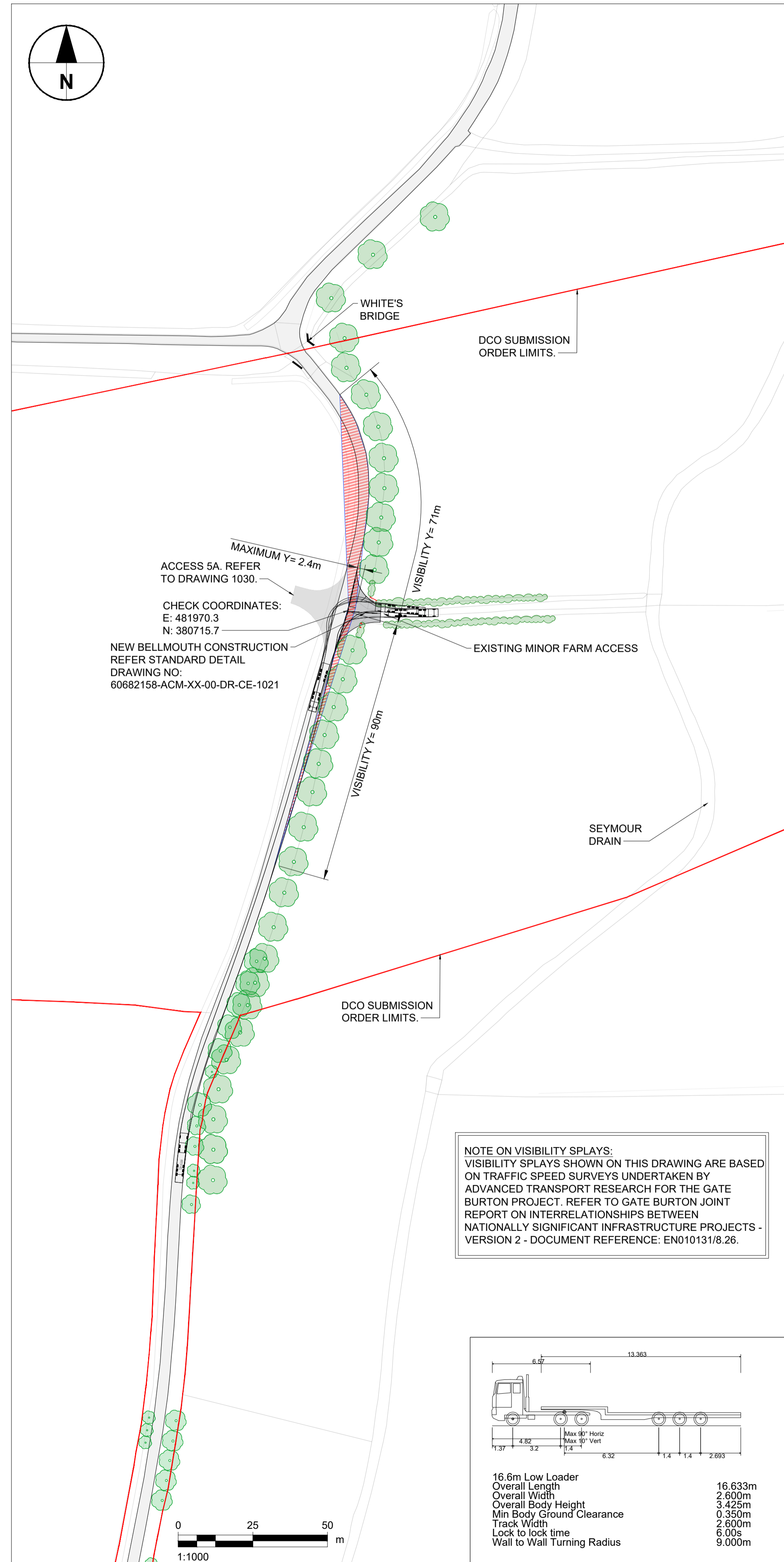
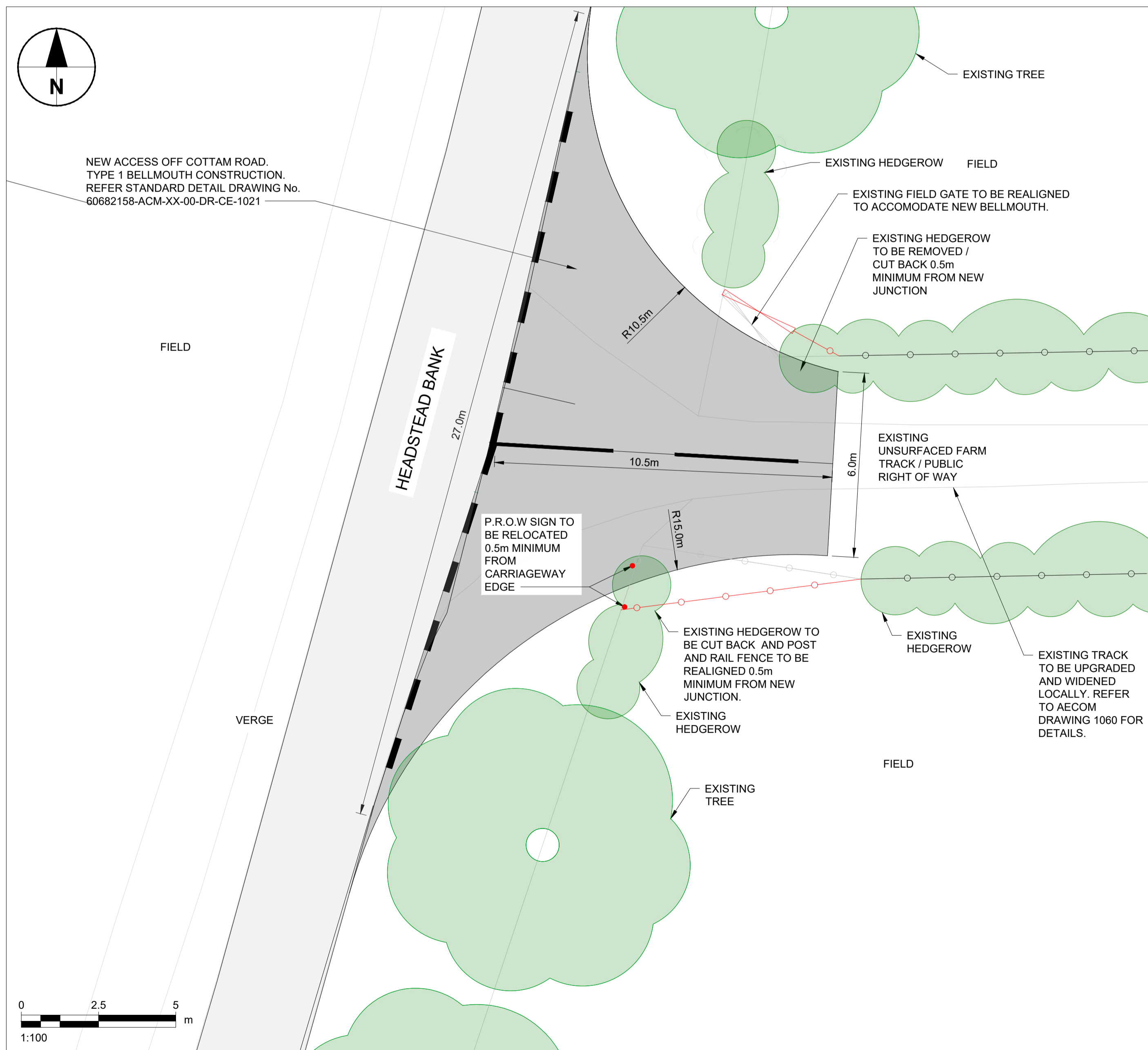
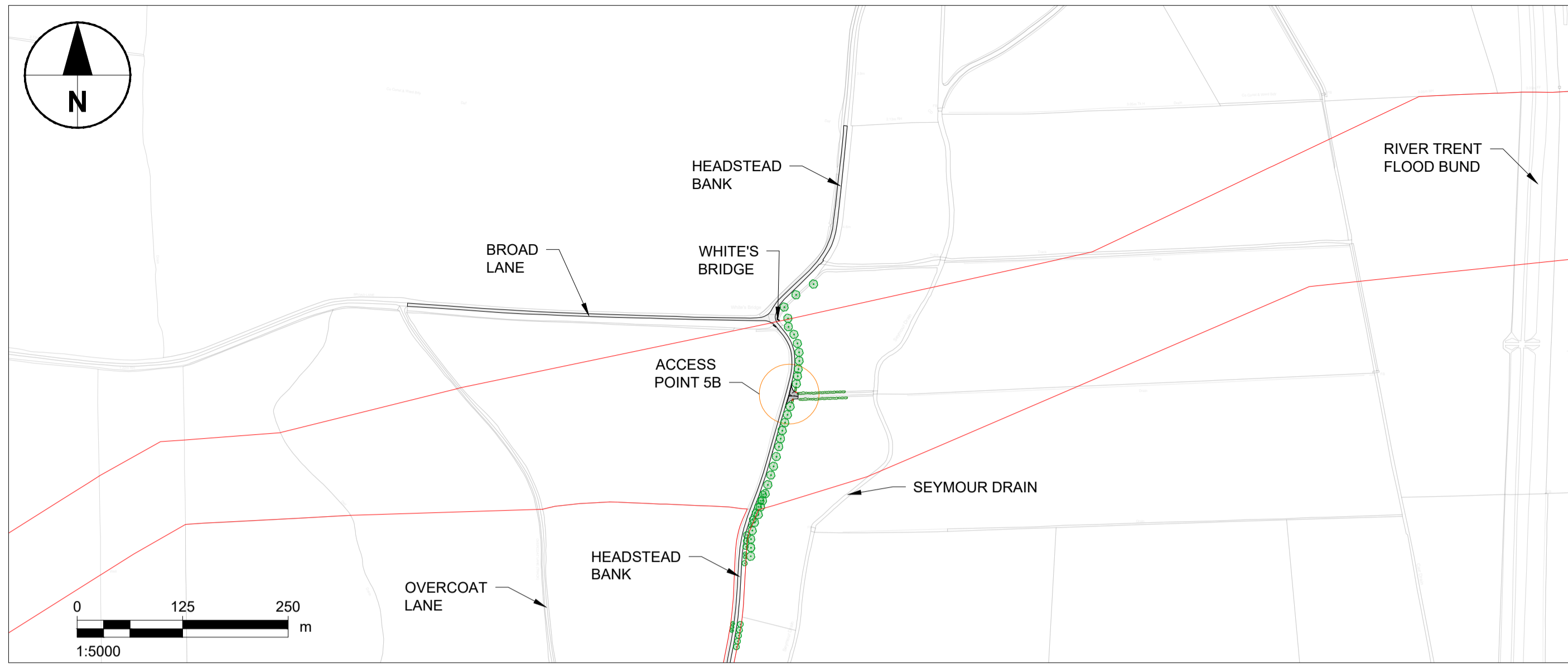

- Notes**
- ALL DIMENSIONS IN METRES UNLESS STATED OTHERWISE.
 - DO NOT SCALE FROM THIS DRAWING USE ONLY FIGURED DIMENSIONS.
 - VISIBILITY Y DISTANCE TO BE AGREED WITH NOTTINGHAMSHIRE COUNTY COUNCIL.

KEY:

- DCO SUBMISSION ORDER LIMITS
- PROPOSED FENCE REALIGNMENT
- EXISTING FENCE
- NEW SINGLE LEAF FIELD GATE
- EXISTING TREES
- EXISTING HEDGEROW / VEGETATION
- VISIBILITY SPLAY
- EXISTING BELLMOUTH TO BE WIDENED AND RESURFACED
- EXISTING CARRIAGEWAY

ISSUE/REVISION

Rev	Date	Description	Dwn/Chk/Appr
D	15.03.24	FINALISED FOR DCO SUBMISSION.	GM/EP/CGY
C	02.02.24	SOUTHBOUND VISIBILITY SPLAYS AMENDED.	GM/EP/JM/CGY
B	06.12.23	FINALISED FOR DISCUSSION WITH LHA.	GM/EP/JM/CGY
A	08.09.23	VISIBILITY X DISTANCE AMENDED.	GM/EP/EP
-	23.08.23	FIRST ISSUE.	MM/EP/EP

NOT FOR CONSTRUCTION
FOR INFORMATION ONLY

NOTE ON VISIBILITY SPLAYS:
 VISIBILITY SPLAYS SHOWN ON THIS DRAWING ARE BASED ON TRAFFIC SPEED SURVEYS UNDERTAKEN BY ADVANCED TRANSPORT RESEARCH FOR THE GATE BURTON PROJECT. REFER TO GATE BURTON JOINT REPORT ON INTERRELATIONSHIPS BETWEEN NATIONALLY SIGNIFICANT INFRASTRUCTURE PROJECTS - VERSION 2 - DOCUMENT REFERENCE: EN010131/8.26.

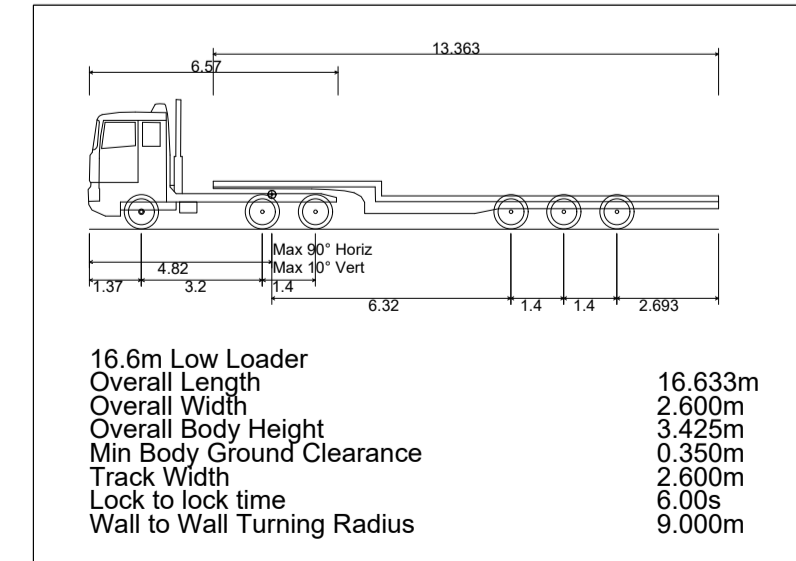

This drawing has been prepared for the use of AECOM's client. It may not be used, modified, reproduced or relied upon by third parties, except as agreed by AECOM or as required by law. AECOM accepts no responsibility, and denies any liability, whatsoever, to any party that uses or relies on this drawing without AECOM's express written consent. Do not scale this document. All measurements must be obtained from the stated dimensions.

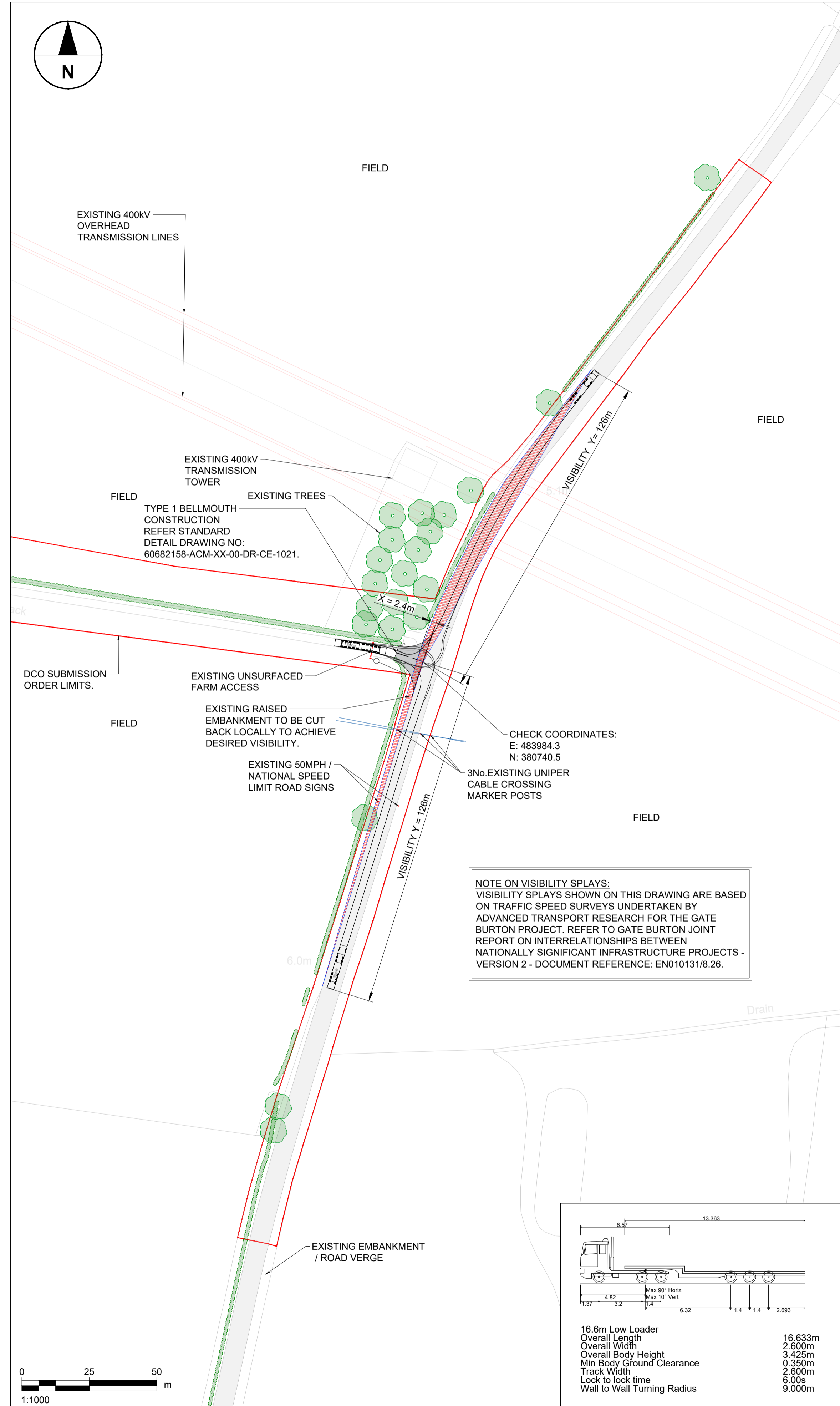
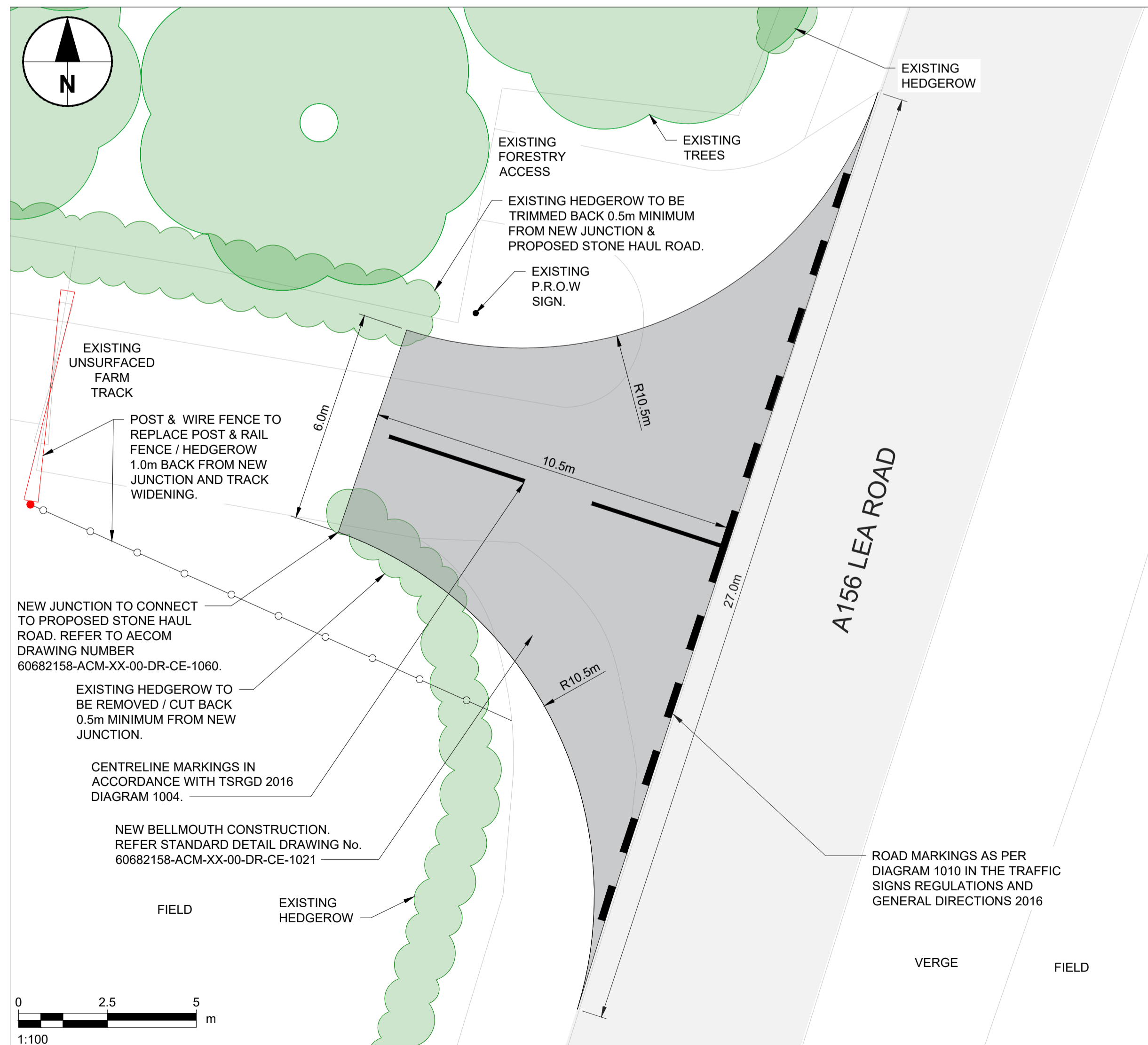
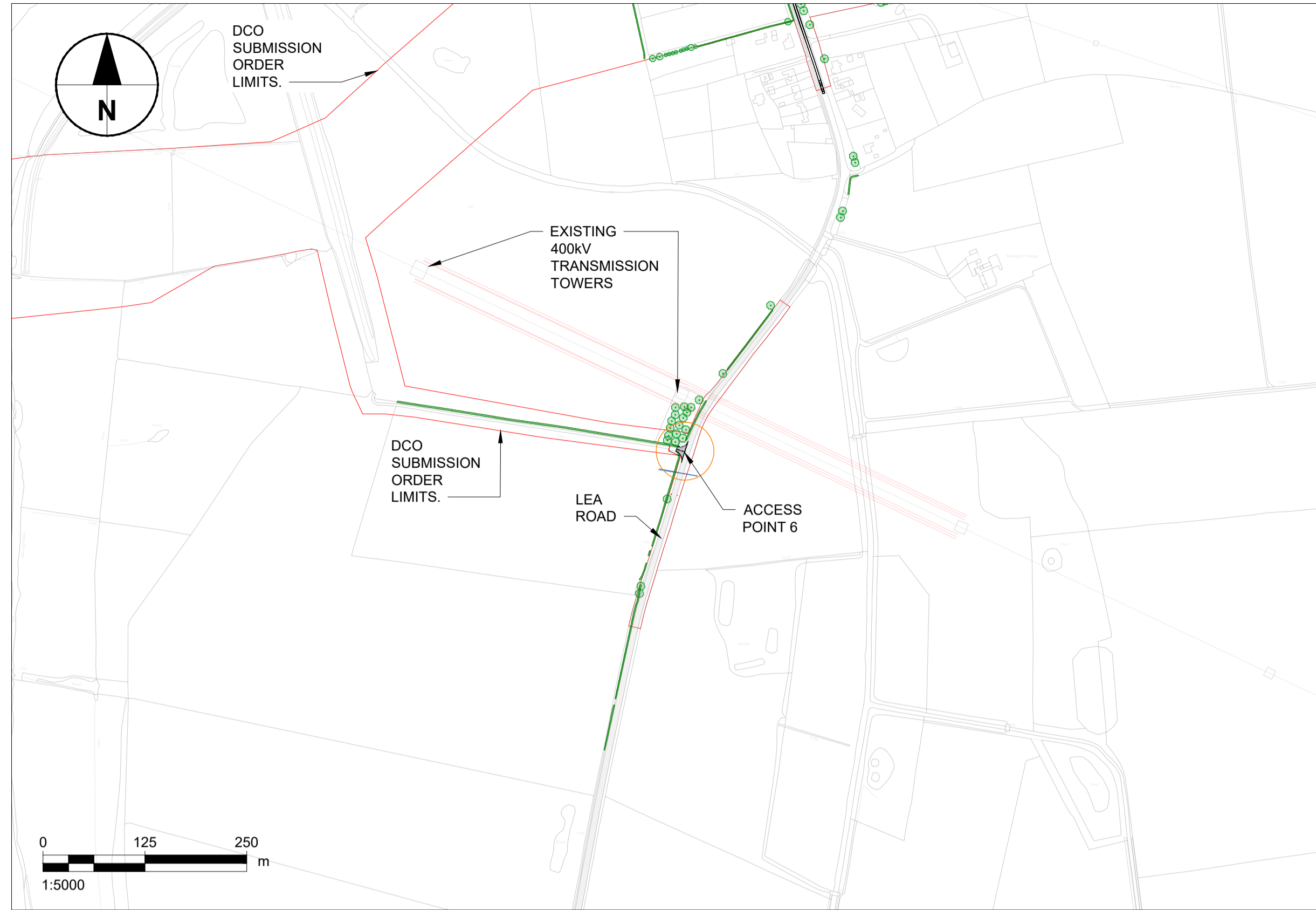

- Notes**
1. ALL DIMENSIONS IN METRES UNLESS STATED OTHERWISE.
 2. DO NOT SCALE FROM THIS DRAWING USE ONLY FIGURED DIMENSIONS.
 3. VISIBILITY X DISTANCE IS BASED ON 2.4m WHICH IS A PERMITTED RELAXATION IN ACCORDANCE WITH CD123 DOCUMENTATION SUBJECT TO APPROVAL BY LINCOLNSHIRE COUNTY COUNCIL.

KEY:

- DCO SUBMISSION ORDER LIMITS
- PROPOSED POST & WIRE FENCE
- NEW DOUBLE LEAF FIELD GATE TO REPLACE EXISTING.
- EXISTING TREES
- EXISTING HEDGEROW / VEGETATION
- VISIBILITY SPLAY
- NEW SURFACED BELLMOUTH
- EXISTING CARRIAGEWAY

ISSUE/REVISION

Rev	Date	Description	Drn/Chk/Appr
D	25.03.24	VEGETATION NOTES AMENDED FOR CLARITY.	GMCE/EP/CGY
C	15.03.24	FINALISED FOR DCO SUBMISSION.	GMCE/EP/CGY
B	06.12.23	FINALISED FOR DISCUSSION WITH LHA.	GMCE/JM/CGY
A	08.09.23	VISIBILITY X DISTANCE AMENDED	GMCE/EP
-	23.08.23	FIRST ISSUE	MM/GMCE/EP

Key Plan
NOT FOR CONSTRUCTION
FOR INFORMATION ONLY

Purpose Of Issue
 DCO SUBMISSION
Project Number
 60682158
Sheet Title
 PROPOSED ACCESS POINT 6
 (A156 LEA ROAD)
Sheet Number
 60682158-ACM-XX-00-DR-CE-1032
Scale: AS SHOWN @ A1 **Rev:** D

- Notes**
1. ALL DIMENSIONS IN METRES UNLESS STATED OTHERWISE.
 2. DO NOT SCALE FROM THIS DRAWING USE ONLY FIGURED DIMENSIONS.
 3. VISIBILITY X DISTANCE IS BASED ON 2.4m WHICH IS A PERMITTED RELAXATION IN ACCORDANCE WITH CD123 DOCUMENTATION SUBJECT TO APPROVAL BY LINCOLNSHIRE COUNTY COUNCIL.

KEY:

- DCO SUBMISSION ORDER LIMITS
- NEW POST & WIRE FENCE
- NEW DOUBLE LEAF FIELD GATE
- EXISTING TREES
- EXISTING HEDGEROW / VEGETATION
- VISIBILITY SPLAY
- NEW SURFACED BELLMOUTH
- EXISTING CARRIAGEWAY

ISSUE/REVISION

Rev	Date	Description	Dwn/Chk/Appr
D	15.03.24	FINALISED FOR DCO SUBMISSION.	GM&E/PCGY
C	06.03.24	FOOTPATH ADDED & JUNCTION AMENDED.	GM&E/MCGY
B	06.12.23	FINALISED FOR DISCUSSION WITH LHA.	GM&E/MCGY
A	08.09.23	VISIBILITY X DISTANCE AMENDED.	GM&E/EP
-	23.08.23	FIRST ISSUE	MM/GM&E/EP

NOT FOR CONSTRUCTION
FOR INFORMATION ONLY

Purpose Of Issue
 DCO SUBMISSION

Project Number
 60682158

Sheet Title
 PROPOSED ACCESS 7
 (A156 HIGH STREET, WESTBOUND)

Sheet Number
 60682158-ACM-XX-00-DR-CE-1033

Scale: AS SHOWN @ A1 **Rev:** D

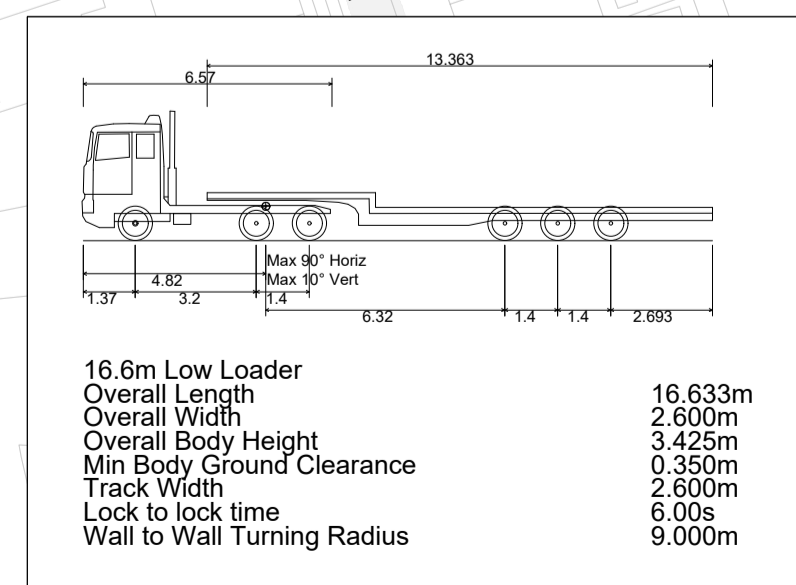
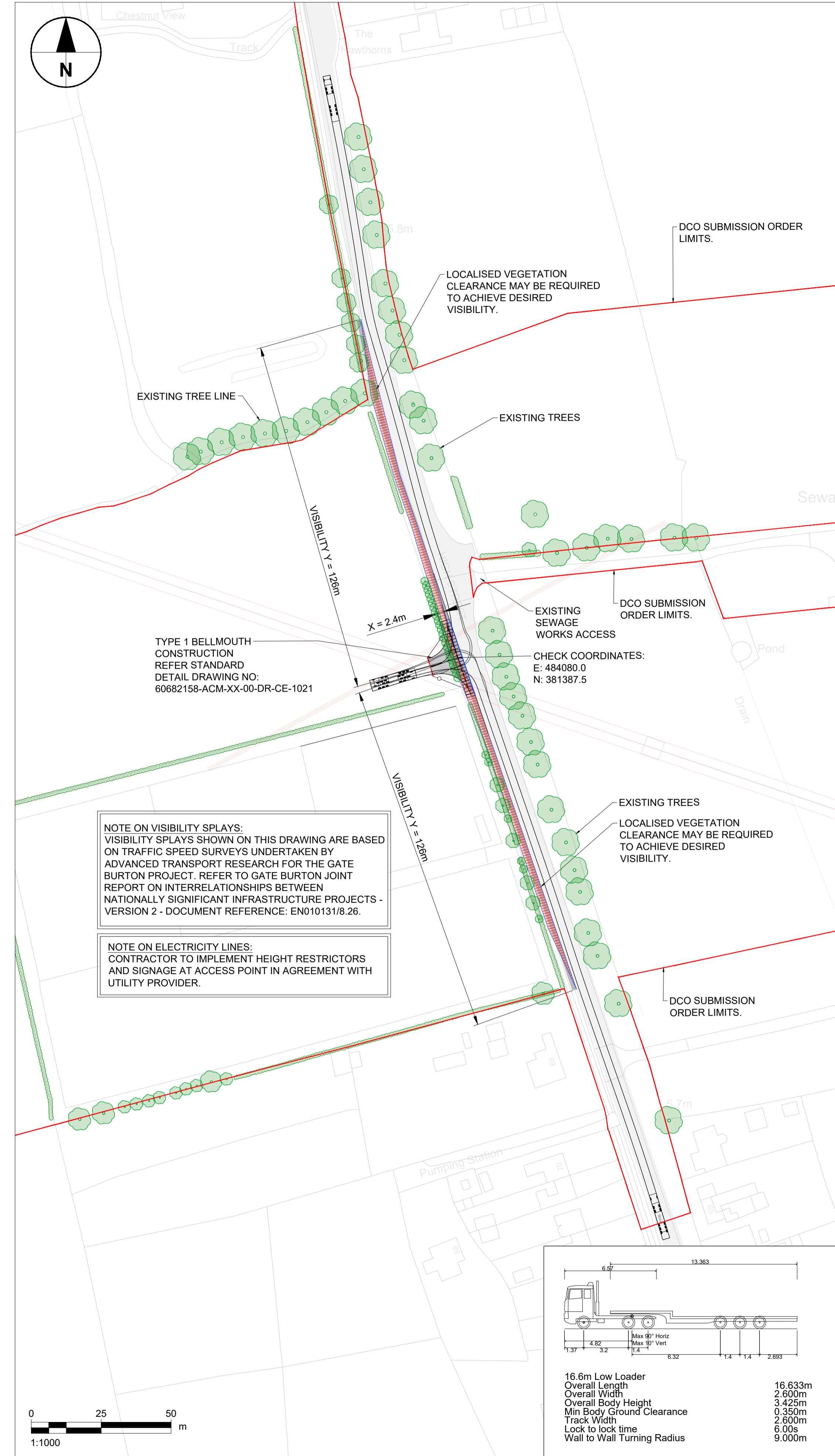
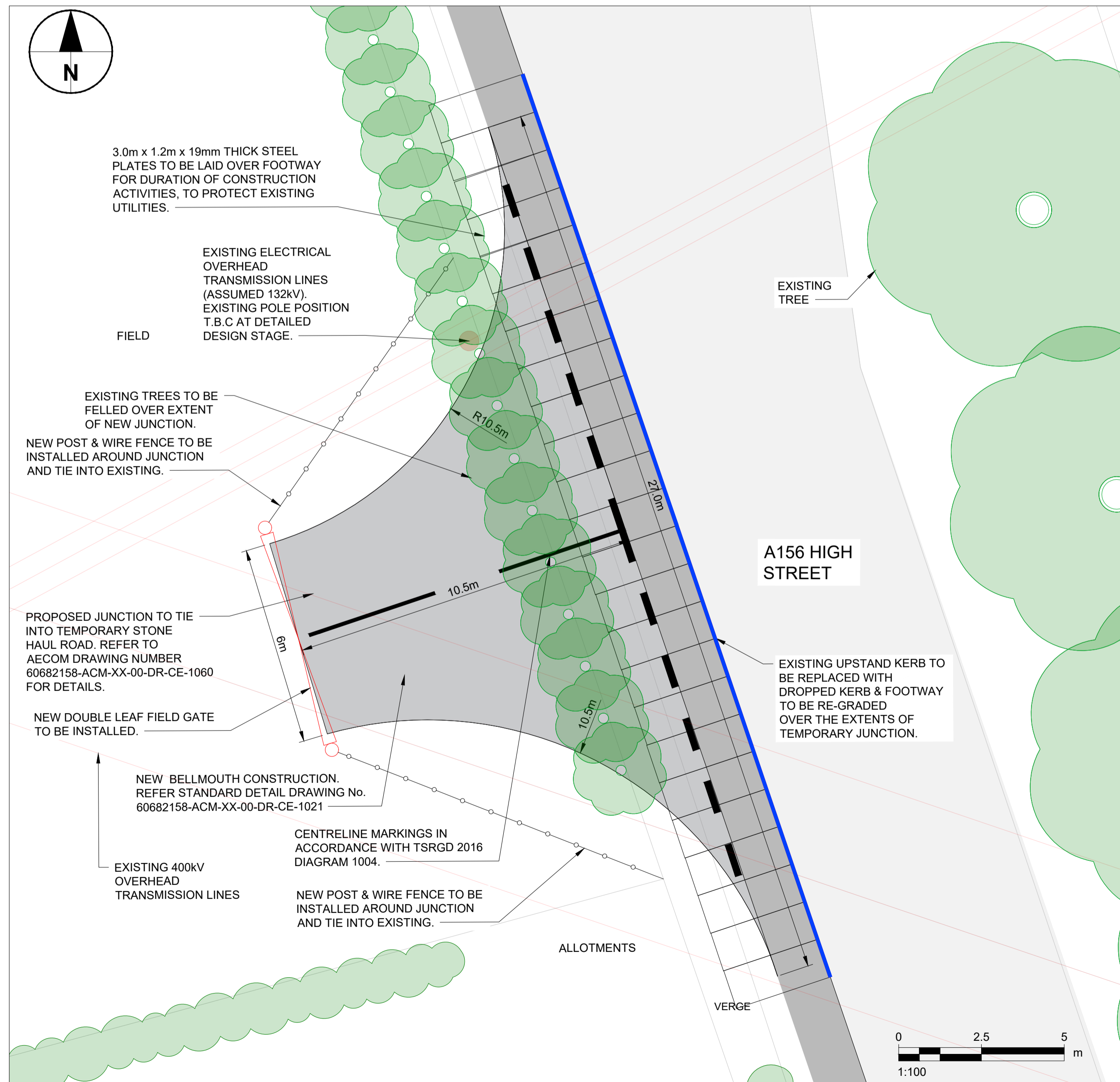
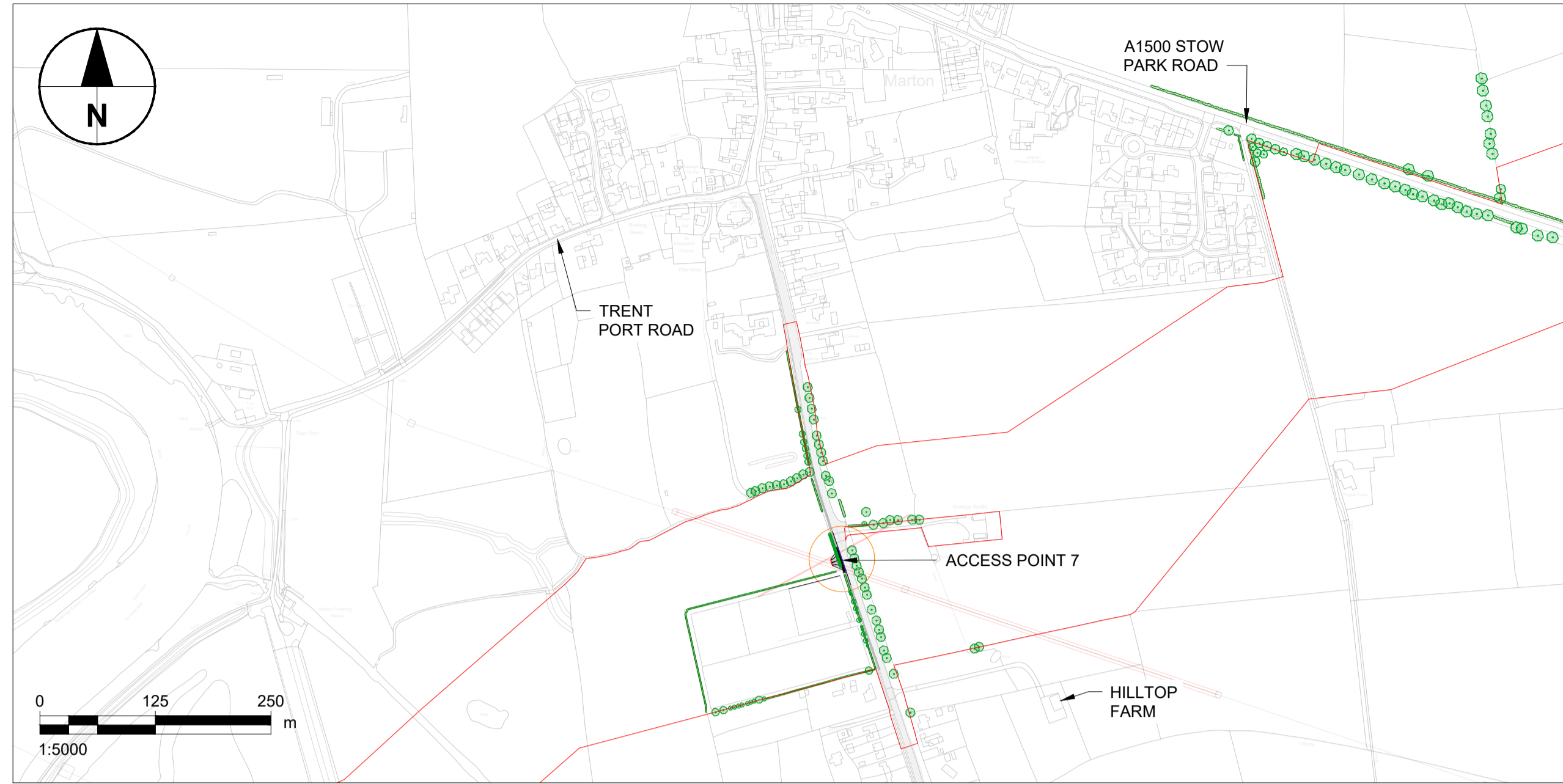

This drawing has been prepared for the use of AECOM's client. It may not be used, modified, reproduced or relied upon by third parties, except as agreed by AECOM or as required by law. AECOM accepts no responsibility, and denies any liability, whatsoever, to any party that uses or relies on this drawing without AECOM's express written consent. Do not scale this document. All measurements must be obtained from the stated dimensions.

KEY:

- DCO SUBMISSION ORDER LIMITS
- EXISTING FENCE
- NEW FIELD GATE TO REPLACE EXISTING
- EXISTING TREES
- EXISTING HEDGEROW / VEGETATION
- VISIBILITY SPLAY
- PROPOSED SURFACED BELLMOUTH TO REPLACE EXISTING FIELD ACCESS
- EXISTING CARRIAGEWAY

ISSUE/REVISION

Rev	Date	Description	Drm/Chk/Appr
C	15.03.24	FINALISED FOR DCO SUBMISSION.	GMCE/EP/CGY
B	06.12.23	FINALISED FOR DISCUSSION WITH LHA.	GMCE/JM/CGY
A	08.09.23	VISIBILITY X DISTANCE AMENDED	GMCE/EP
-	23.08.23	FIRST ISSUE	MM/EP

NOT FOR CONSTRUCTION
FOR INFORMATION ONLY

Purpose Of Issue

DCO SUBMISSION

Project Number

60682158

Sheet Title

PROPOSED ACCESS POINT 8
 (A156 HIGH STREET, EASTBOUND)

Sheet Number

60682158-ACM-XX-00-DR-CE-1034

Scale: AS SHOWN @ A1 Rev: C

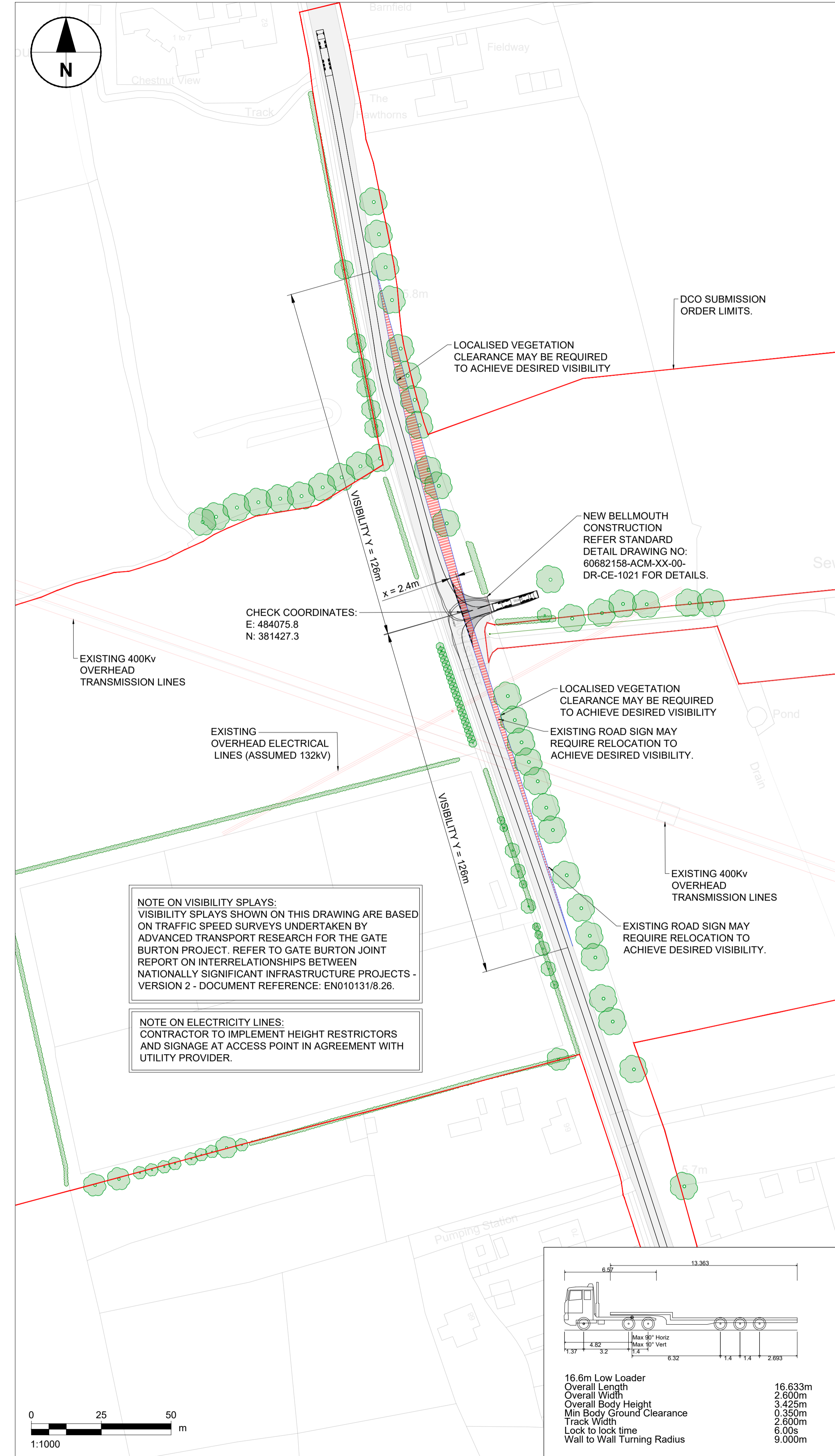
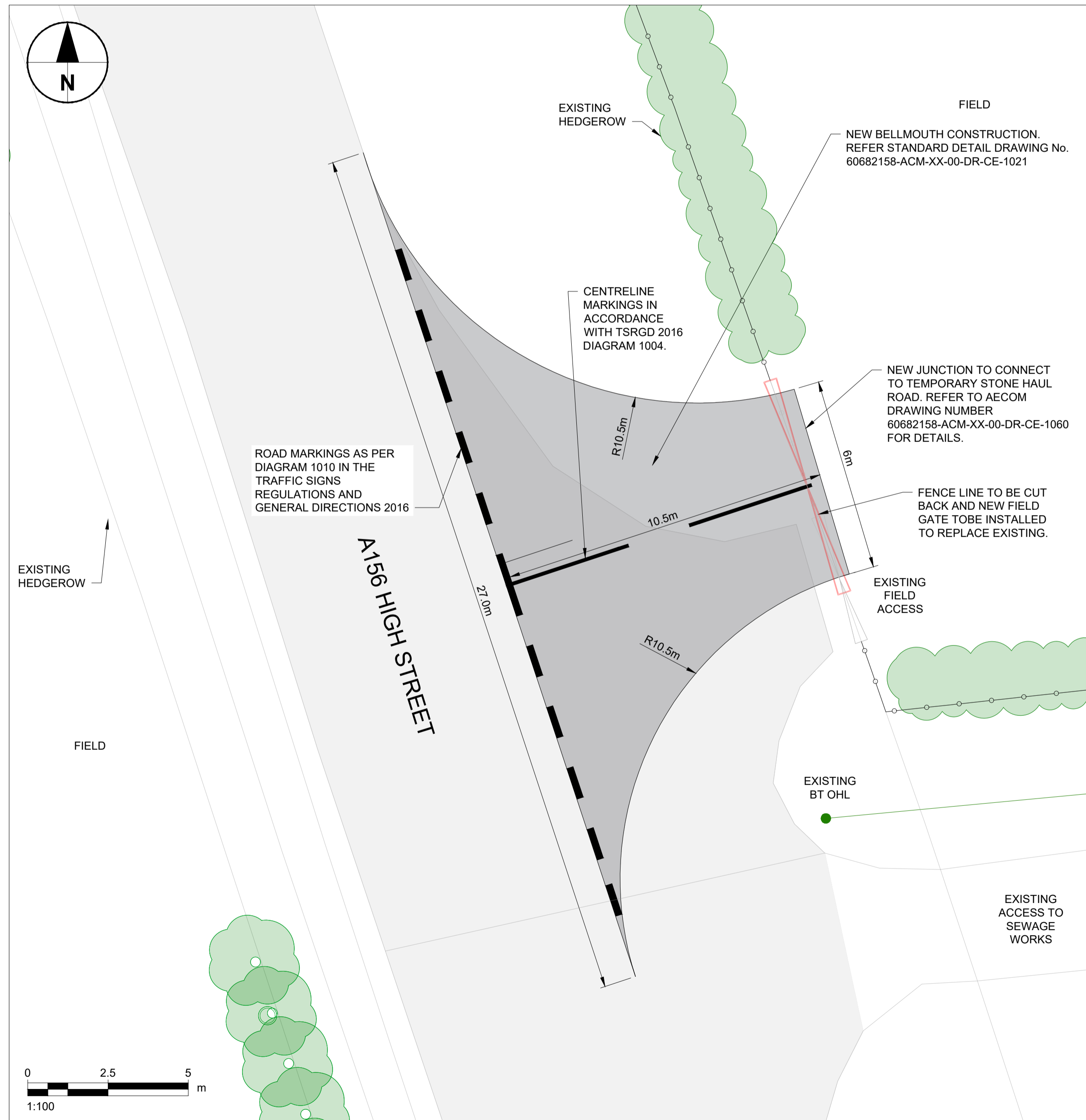
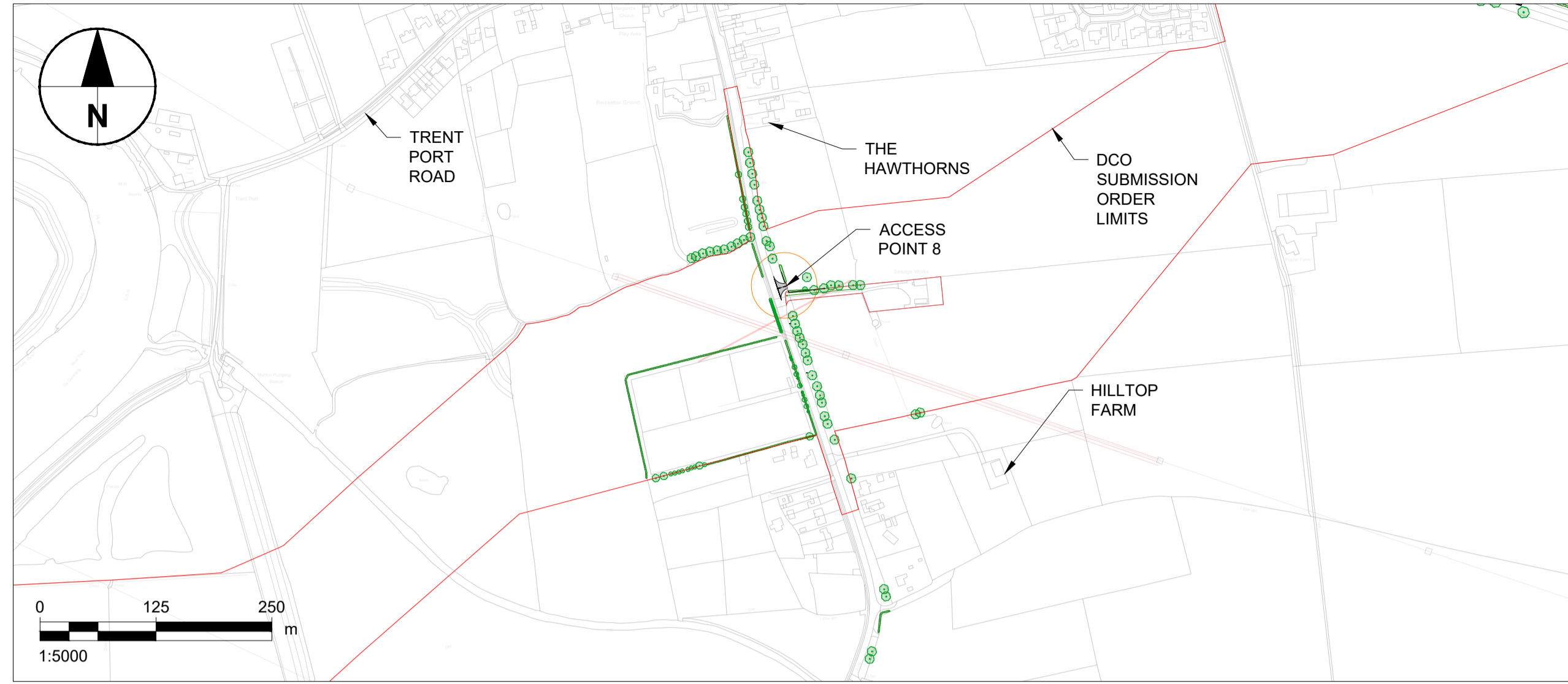

NOTE ON VISIBILITY SPLAYS:
 VISIBILITY SPLAYS SHOWN ON THIS DRAWING ARE BASED ON TRAFFIC SPEED SURVEYS UNDERTAKEN BY ADVANCED TRANSPORT RESEARCH FOR THE GATE BURTON PROJECT. REFER TO GATE BURTON JOINT REPORT ON INTERRELATIONSHIPS BETWEEN NATIONALLY SIGNIFICANT INFRASTRUCTURE PROJECTS - VERSION 2 - DOCUMENT REFERENCE: EN010131/8.26.

NOTE ON ELECTRICITY LINES:
 CONTRACTOR TO IMPLEMENT HEIGHT RESTRICTORS AND SIGNAGE AT ACCESS POINT IN AGREEMENT WITH UTILITY PROVIDER.

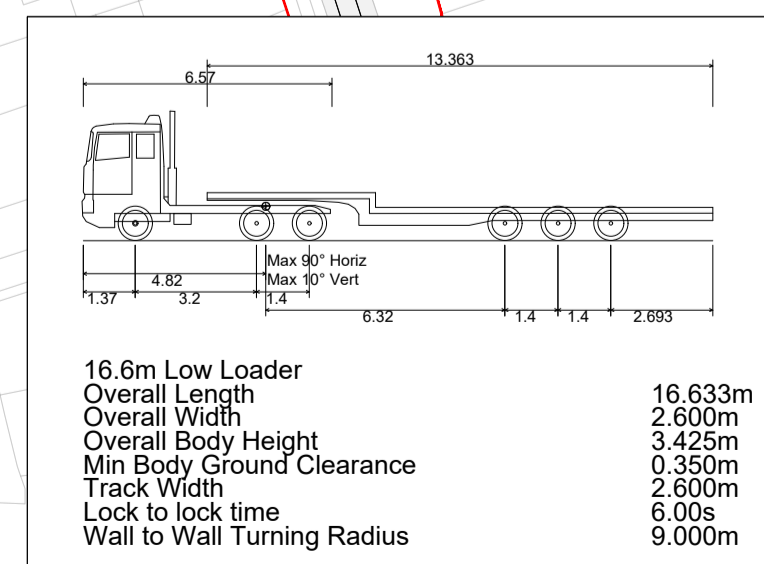

This drawing has been prepared for the use of AECOM's client. It may not be used, modified, reproduced or relied upon by third parties, except as required by law. AECOM accepts no responsibility, and denies any liability, whatsoever, to any party that uses or relies on this drawing without AECOM's express written consent. Do not scale this document. All measurements must be obtained from the stated dimensions.

KEY:

- DCO SUBMISSION ORDER LIMITS
- PROPOSED POST & WIRE FENCE
- PROPOSED DOUBLE LEAF FIELD GATE
- EXISTING TREES
- EXISTING HEDGEROW / VEGETATION
- VISIBILITY SPLAY
- PROPOSED SURFACED BELLMOUTH
- EXISTING CARRIAGEWAY

ISSUE/REVISION

Rev	Date	Description	Drn/Chk/Appr
D	15.03.24	FINALISED FOR DCO SUBMISSION.	GMCE/EP/CGY
C	06.03.24	MINOR AMENDMENTS FOR CLARITY.	GMCE/EP/CGY
B	06.12.23	FINALISED FOR DISCUSSION WITH LHA.	GMCE/AM/CGY
A	08.09.23	VISIBILITY X DISTANCE AMENDED	GMCE/AM/EP
-	23.08.23	FIRST ISSUE	MM/AM/EP

NOT FOR CONSTRUCTION
FOR INFORMATION ONLY

Purpose Of Issue
 DCO SUBMISSION

Project Number
 60682158

Sheet Title
 PROPOSED ACCESS POINT 9
 (A1500 STOW PARK ROAD)

Sheet Number
 60682158-ACM-XX-00-DR-CE-1035

Scale: AS SHOWN @ A1 **Rev:** D

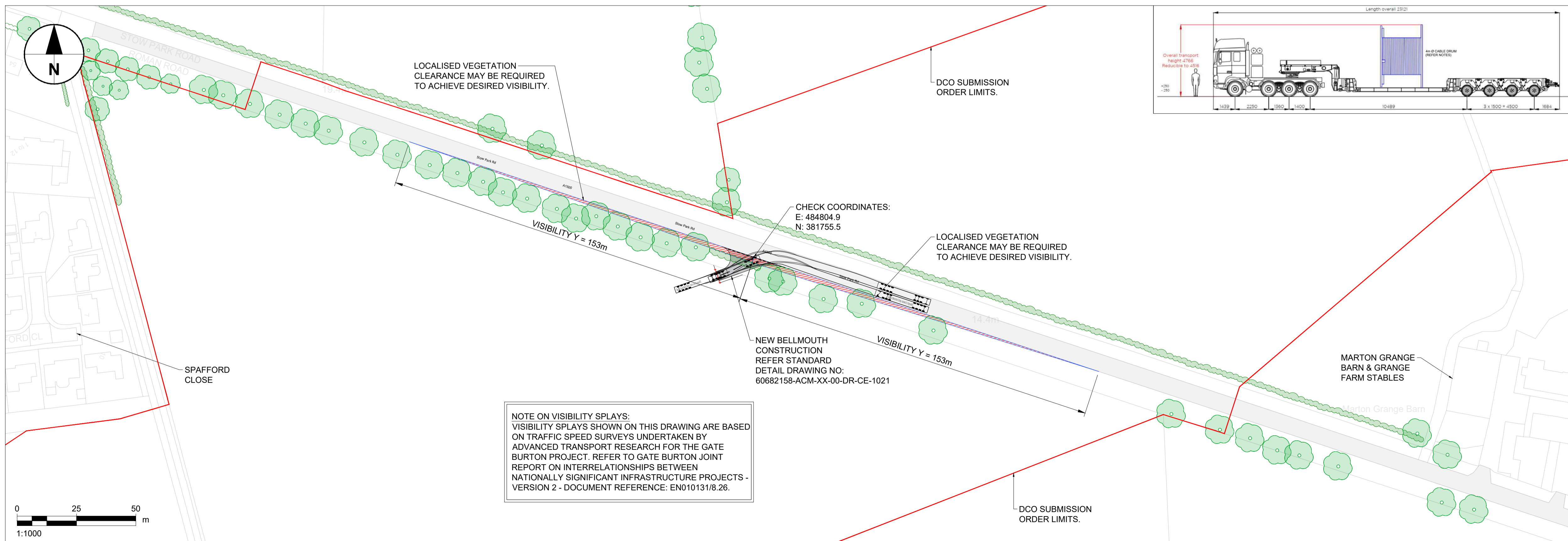
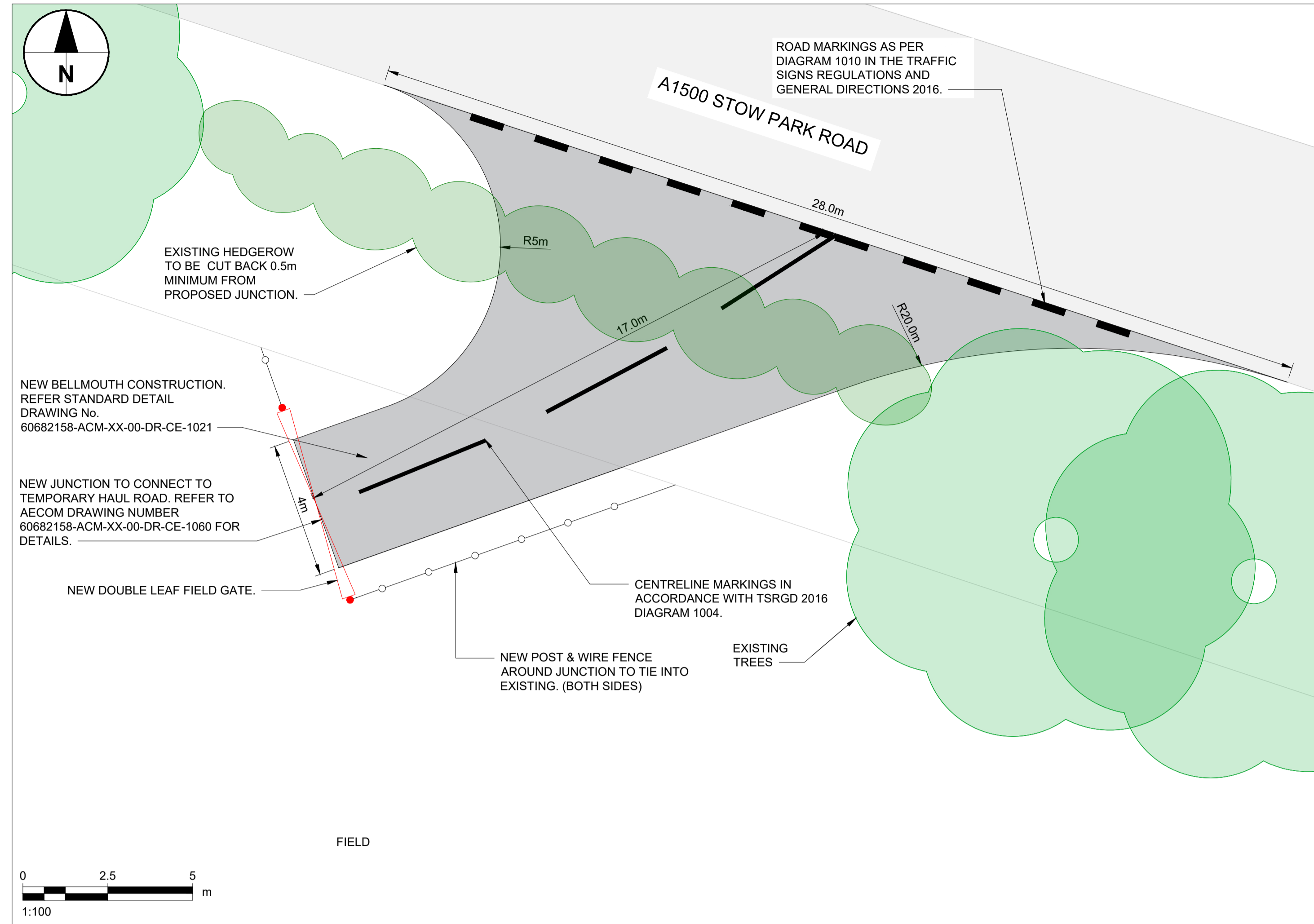
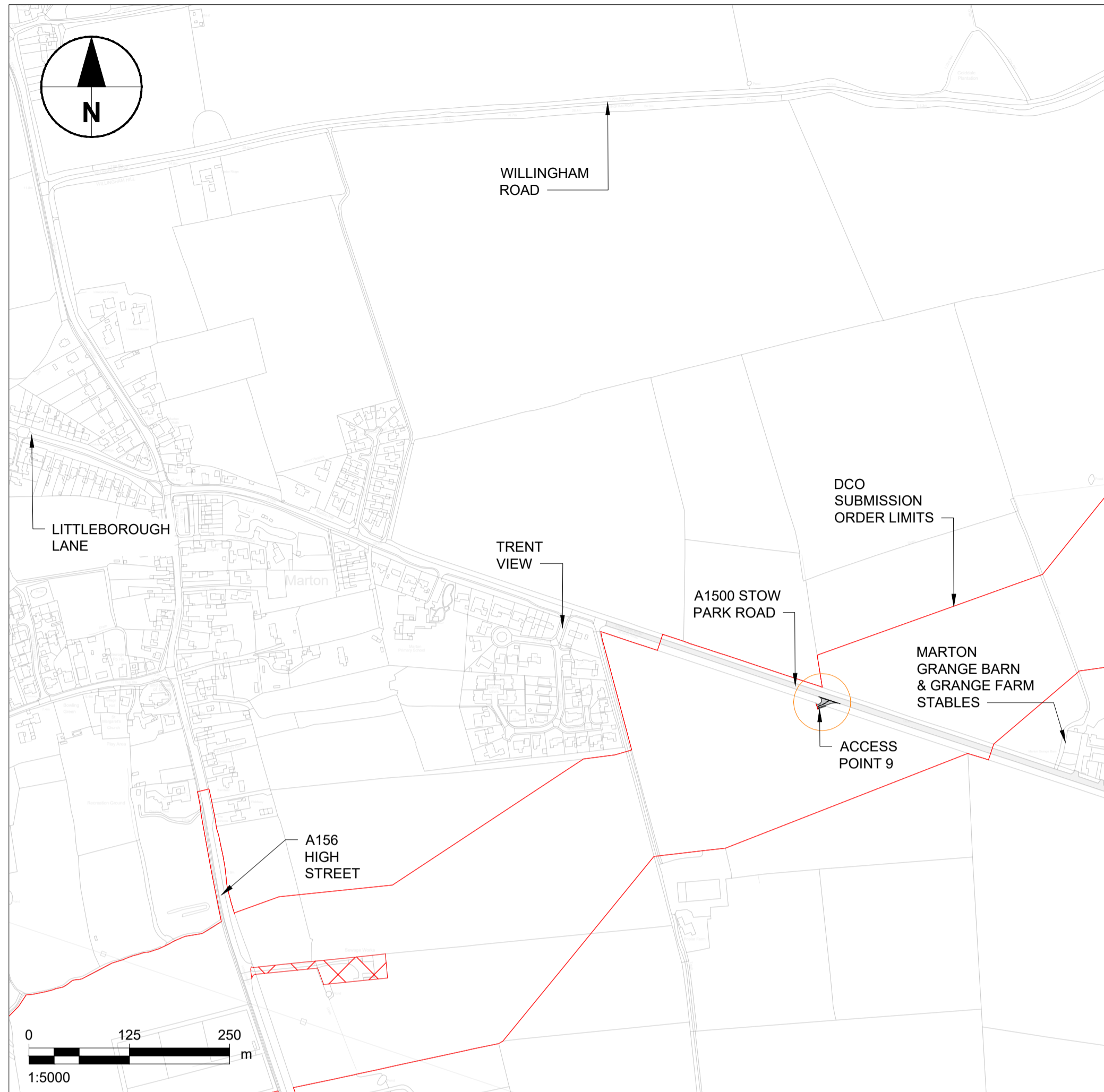

NOTE ON VISIBILITY SPLAYS:
 VISIBILITY SPLAYS SHOWN ON THIS DRAWING ARE BASED ON TRAFFIC SPEED SURVEYS UNDERTAKEN BY ADVANCED TRANSPORT RESEARCH FOR THE GATE BURTON PROJECT. REFER TO GATE BURTON JOINT REPORT ON INTERRELATIONSHIPS BETWEEN NATIONALLY SIGNIFICANT INFRASTRUCTURE PROJECTS - VERSION 2 - DOCUMENT REFERENCE: EN010131/8.26.

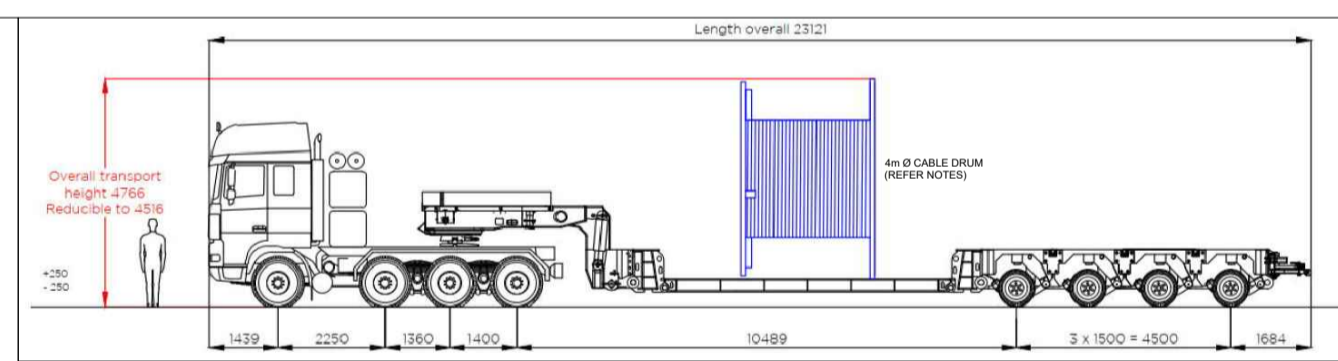

KEY:

- DCO SUBMISSION ORDER LIMITS
- PROPOSED POST & WIRE FENCE
- PROPOSED DOUBLE LEAF FIELD GATE
- EXISTING TREES
- EXISTING HEDGEROW / VEGETATION
- VISIBILITY SPLAY
- PROPOSED SURFACED BELLMOUTH
- EXISTING CARRIAGEWAY

ISSUE/REVISION

Rev	Date	Description	Dwn/Chk/Appr
C	15.03.24	FINALISED FOR DCO SUBMISSION.	GMCE/EP/CGY
B	06.12.23	FINALISED FOR DISCUSSION WITH LHA.	GMCE/JM/CGY
A	08.09.23	VISIBILITY X DISTANCE AMENDED	GMCE/EP
-	23.08.23	FIRST ISSUE	MM/AM/EP

NOT FOR CONSTRUCTION
FOR INFORMATION ONLY

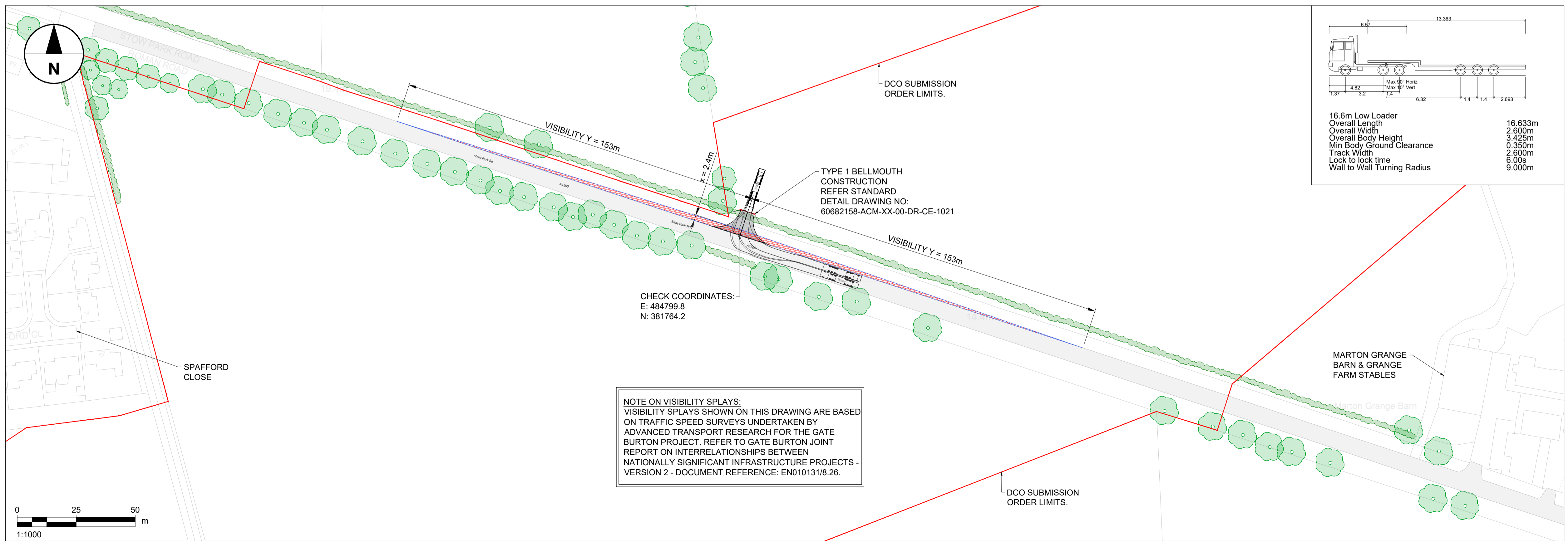
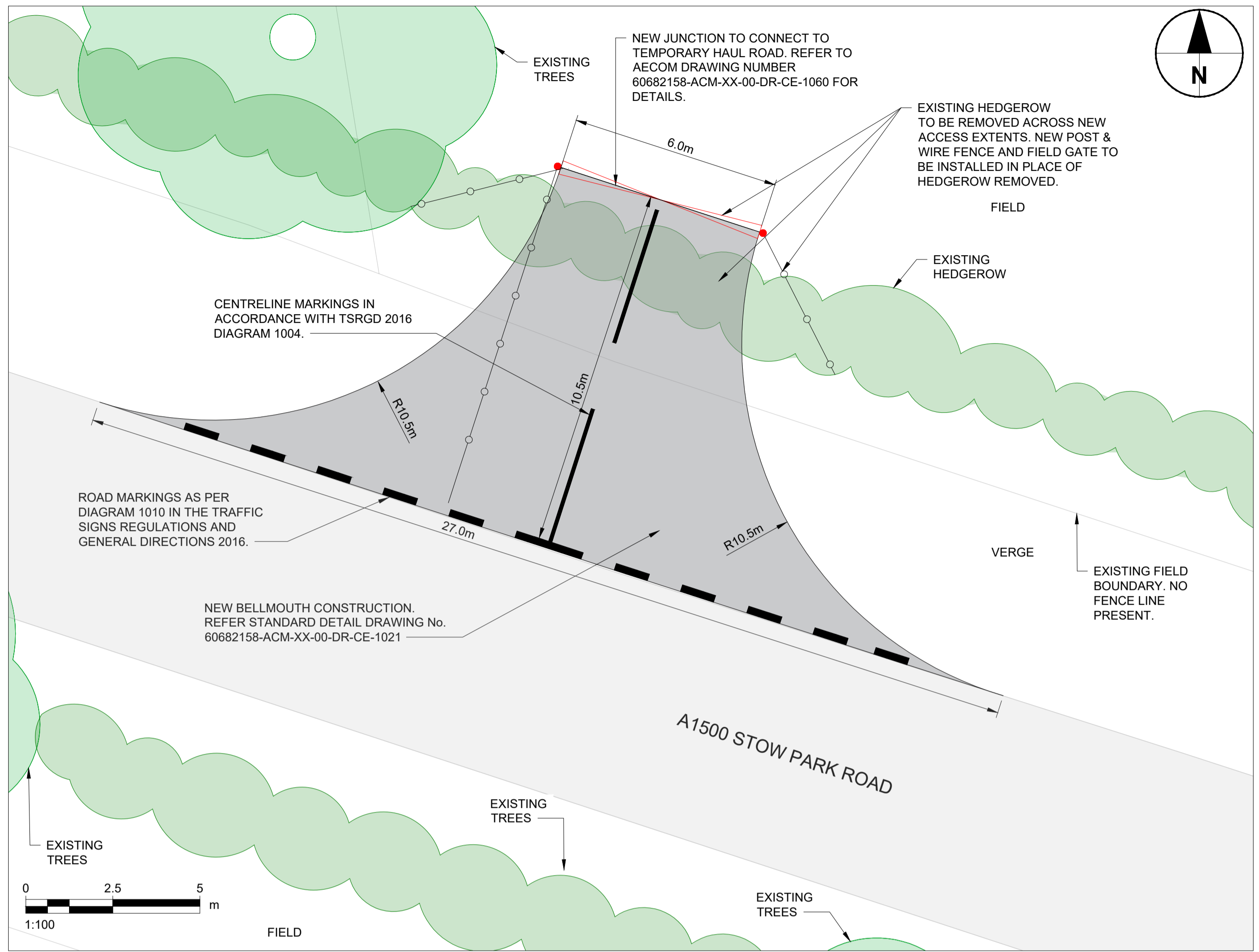
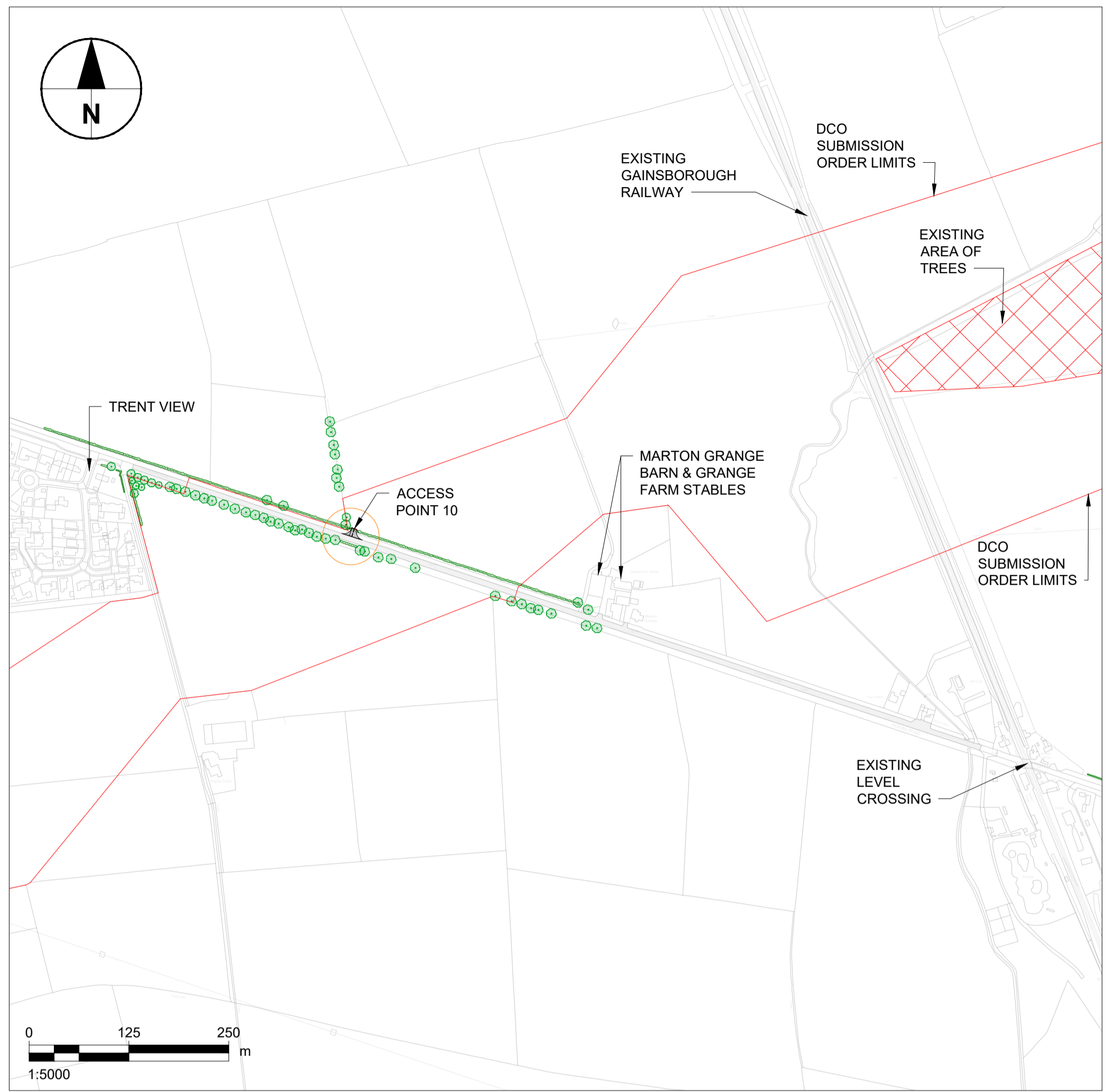

NOTE ON VISIBILITY SPLAYS:
 VISIBILITY SPLAYS SHOWN ON THIS DRAWING ARE BASED ON TRAFFIC SPEED SURVEYS UNDERTAKEN BY ADVANCED TRANSPORT RESEARCH FOR THE GATE BURTON PROJECT. REFER TO GATE BURTON JOINT REPORT ON INTERRELATIONSHIPS BETWEEN NATIONALLY SIGNIFICANT INFRASTRUCTURE PROJECTS - VERSION 2 - DOCUMENT REFERENCE: EN010131/8.26.

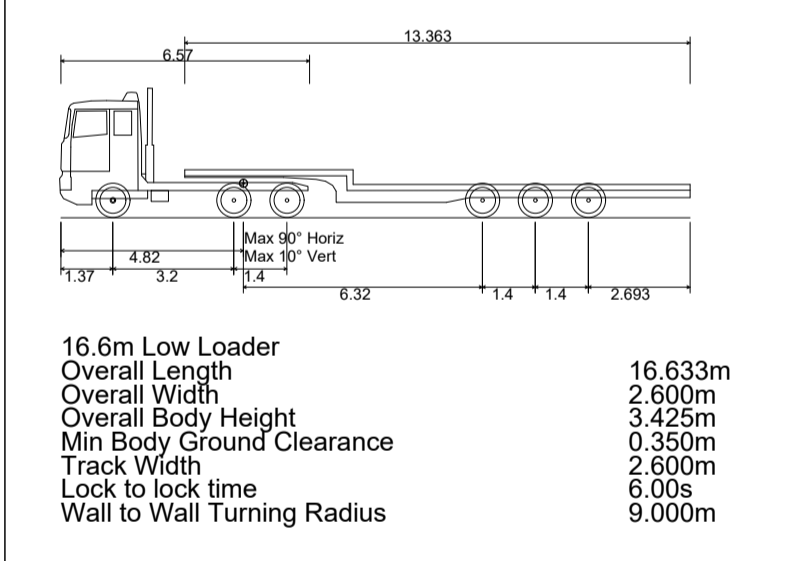

16.6m Low Loader

Overall Length	16.633m
Overall Width	2.600m
Overall Body Height	3.425m
Min Body Ground Clearance	0.350m
Track Width	2.600m
Lock to lock time	6.00s
Wall to Wall Turning Radius	9.000m

KEY:

- DCO SUBMISSION ORDER LIMITS
- PROPOSED POST & WIRE FENCE
- PROPOSED DOUBLE LEAF FIELD GATE TO REPLACE EXISTING DILAPIDATED GATES.
- EXISTING TREES
- EXISTING HEDGEROW / VEGETATION
- VISIBILITY SPLAY
- EXISTING BELLMOUTH TO BE RESURFACED AND WIDENED.
- EXISTING CARRIAGEWAY

ISSUE/REVISION

Rev	Date	Description	Dm/Chk/Appr
D	25.03.24	MINOR TEXT AMENDMENTS FOR CLARITY.	GMCE/EP/CGY
C	15.03.24	FINALISED FOR DCO SUBMISSION.	GMCE/EP/CGY
B	06.12.23	FINALISED FOR DISCUSSION WITH LHA.	GMCE/JM/CGY
A	08.09.23	VISIBILITY X DISTANCE AMENDED	GMCE/EP/CGY
-	23.08.23	FIRST ISSUE	MM/EP/CGY

NOT FOR CONSTRUCTION
FOR INFORMATION ONLY

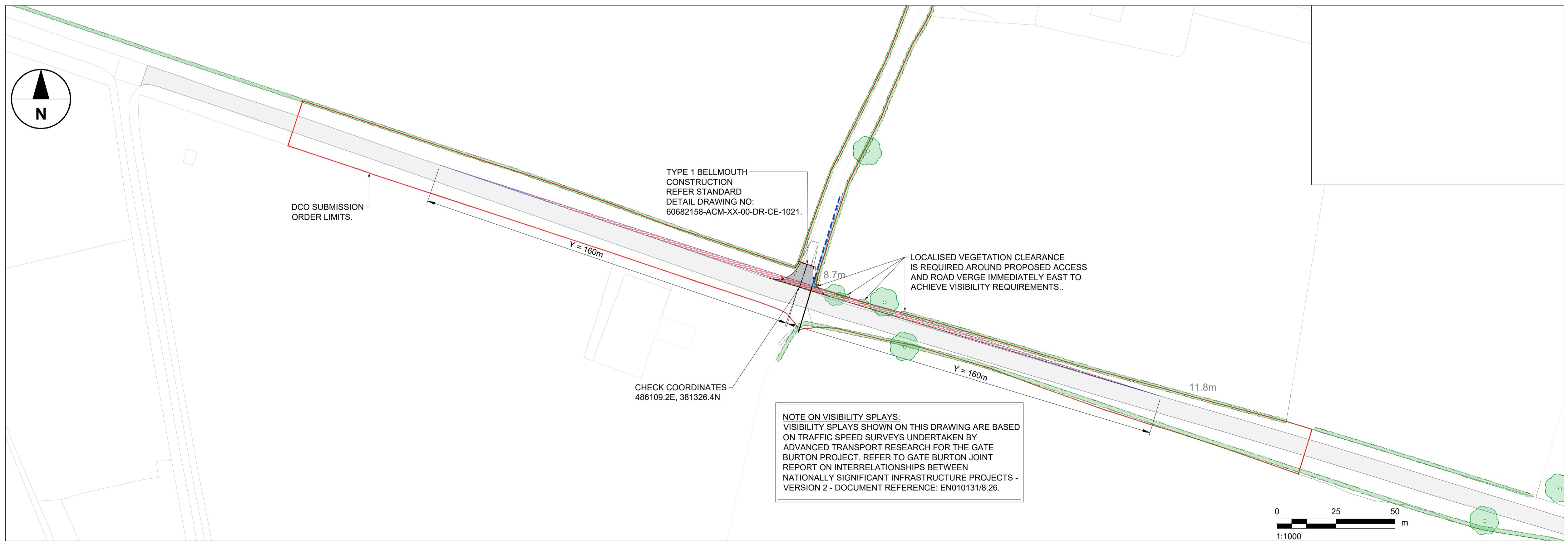
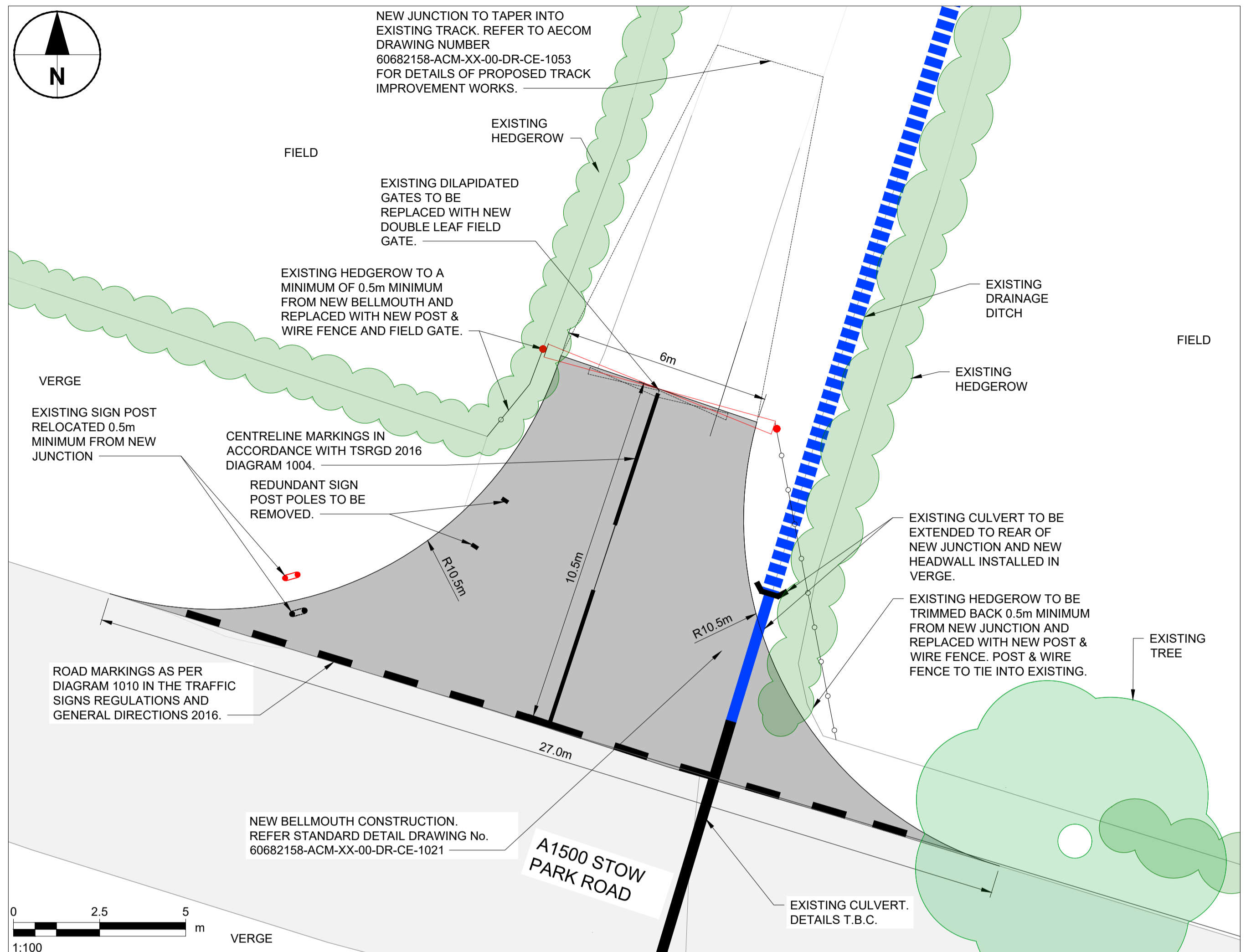
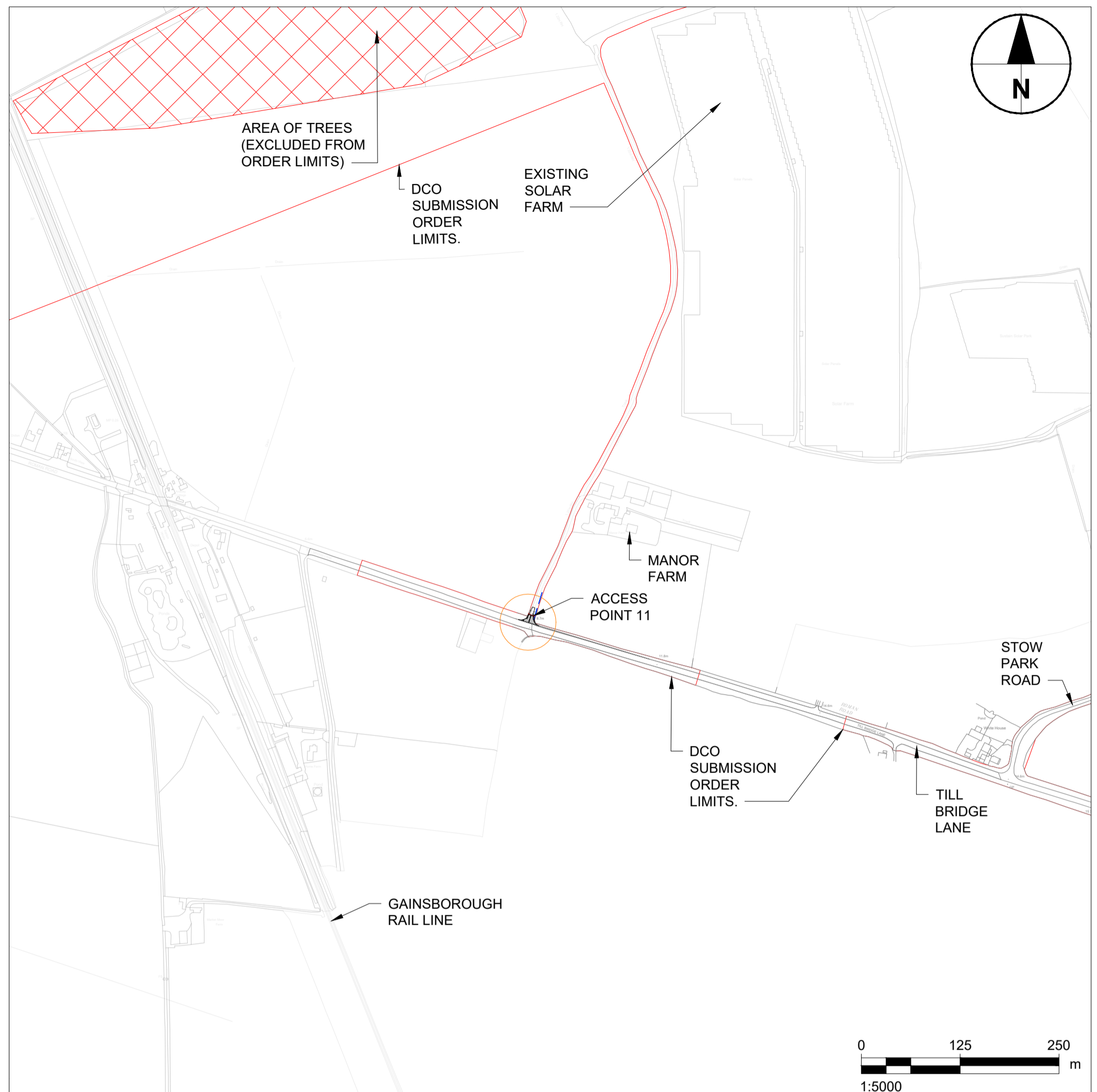

This drawing has been prepared for the use of AECOM's client. It may not be used, modified, reproduced or relied upon by third parties, except as agreed by AECOM or as required by law. AECOM accepts no responsibility, and denies any liability, whatsoever, to any party that uses or relies on this drawing without AECOM's express written consent. All measurements must be obtained from the stated dimensions.

KEY:

- DCO SUBMISSION ORDER LIMITS
- EXISTING TREES
- EXISTING HEDGEROW / VEGETATION
- VISIBILITY SPLAY
- EXISTING BELLMOUTH
- EXISTING CARRIAGEWAY

ISSUE/REVISION

Rev	Date	Description	Drm/Chk/Appr
C	15.03.24	FINALISED FOR DCO SUBMISSION	GM/GM/ECGY
B	06.12.23	MINOR AMENDMENTS	GM/EJ/MCGY
A	08.09.23	VISIBILITY X DISTANCE AMENDED	GM/GM/EP
-	21.08.23	FIRST ISSUE	MM/GM/EP

NOT FOR CONSTRUCTION
FOR INFORMATION ONLY

Purpose Of Issue

DCO SUBMISSION

Project Number

60682158

Sheet Title

PROPOSED ACCESS POINT 12A
(A1500 TILL BRIDGE LANE)

Sheet Number

60682158-ACM-XX-00-DR-CE-1038

Scale: AS SHOWN @ A1 Rev: C

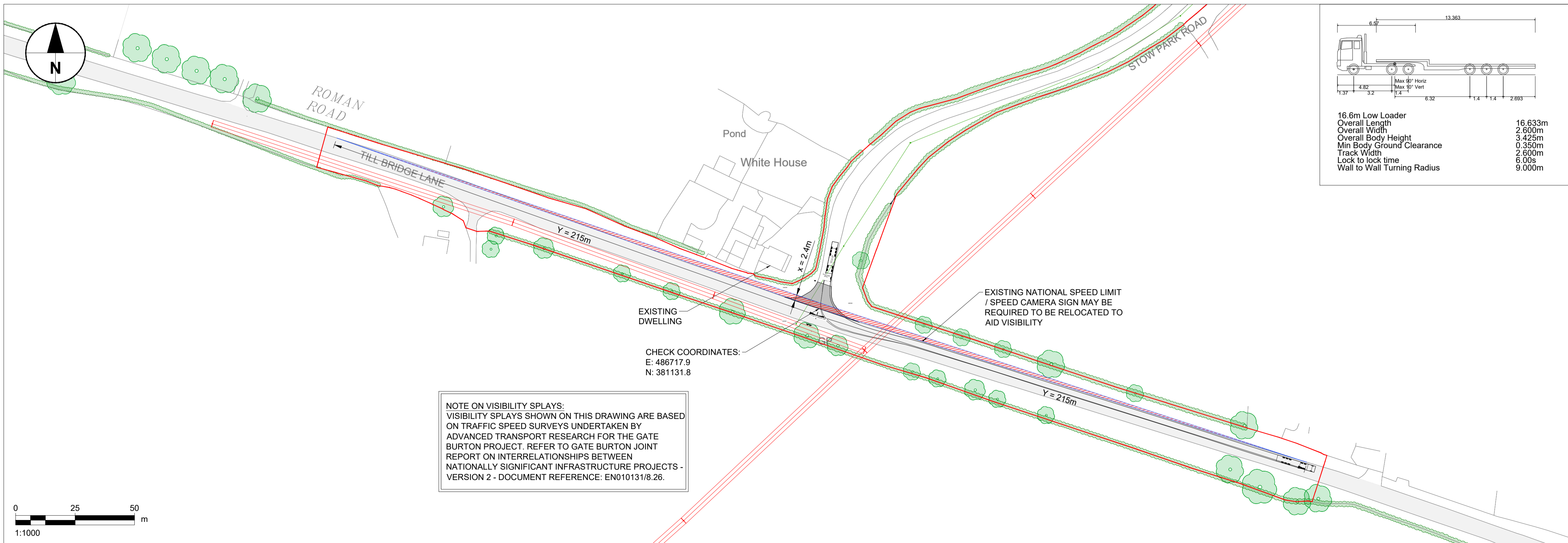
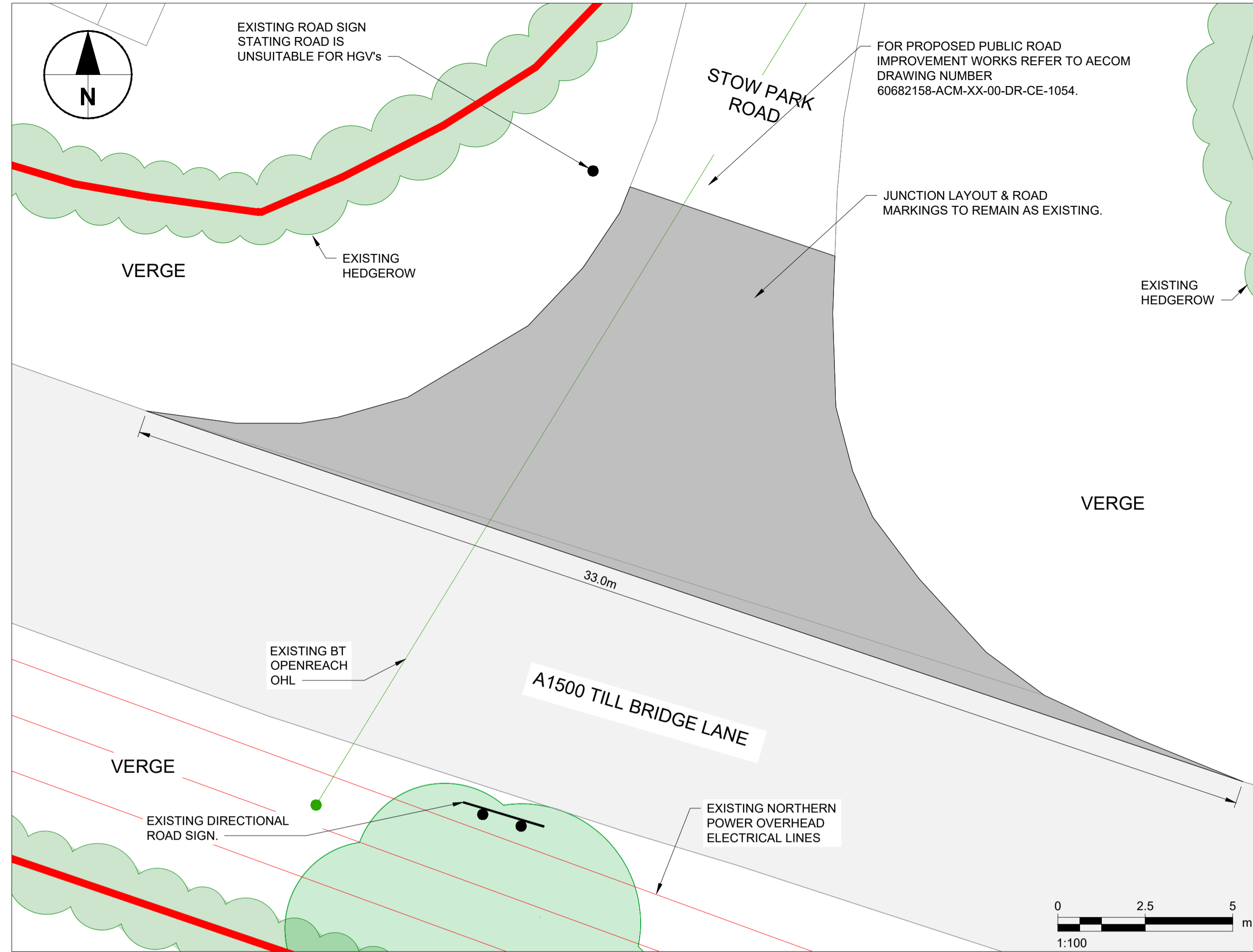
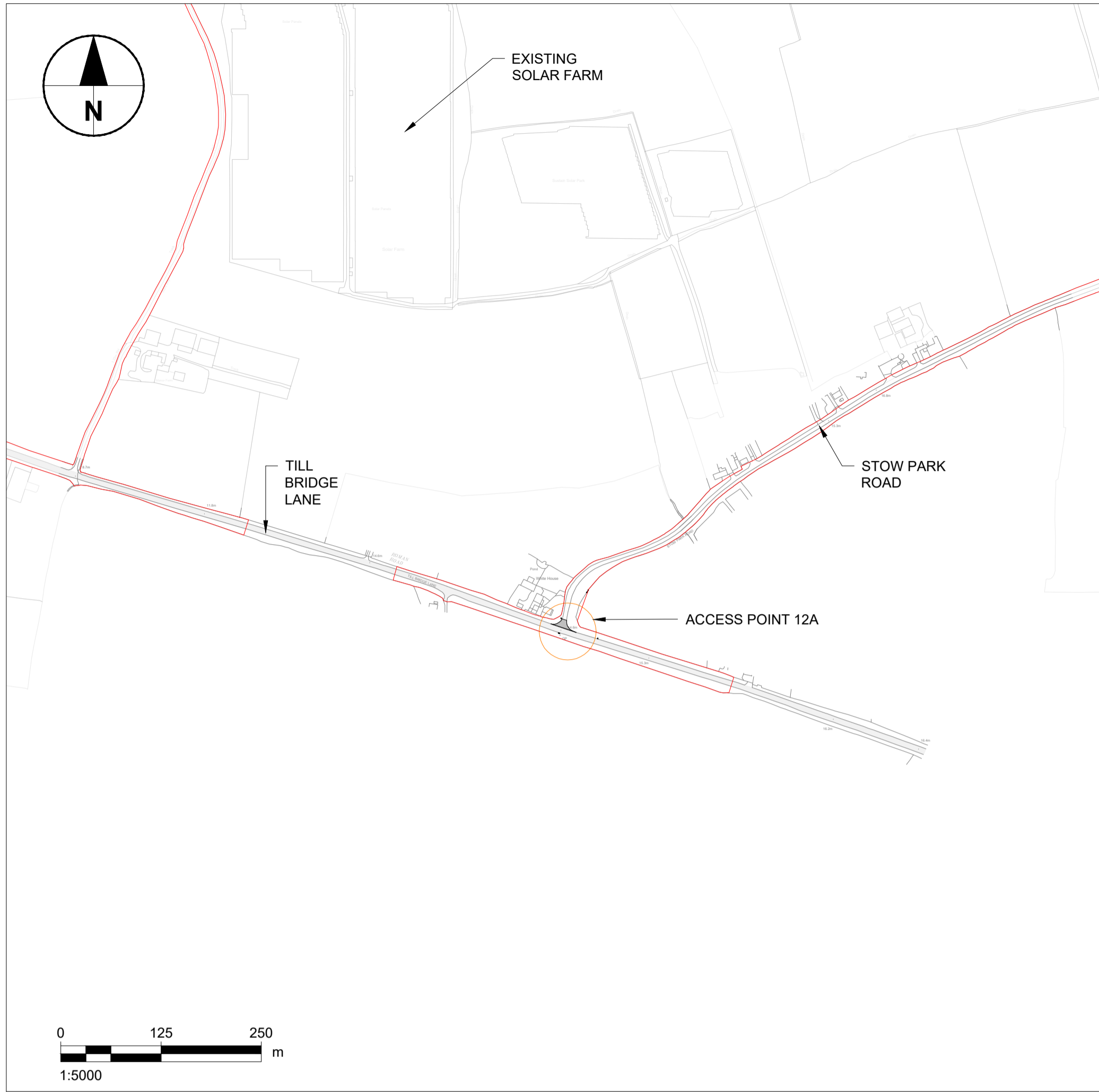

NOTE ON VISIBILITY SPLAYS:
VISIBILITY SPLAYS SHOWN ON THIS DRAWING ARE BASED ON TRAFFIC SPEED SURVEYS UNDERTAKEN BY ADVANCED TRANSPORT RESEARCH FOR THE GATE BURTON PROJECT. REFER TO GATE BURTON JOINT REPORT ON INTERRELATIONSHIPS BETWEEN NATIONALLY SIGNIFICANT INFRASTRUCTURE PROJECTS - VERSION 2 - DOCUMENT REFERENCE: EN010131/8.26.

CHECK COORDINATES:
E: 486717.9
N: 381131.8

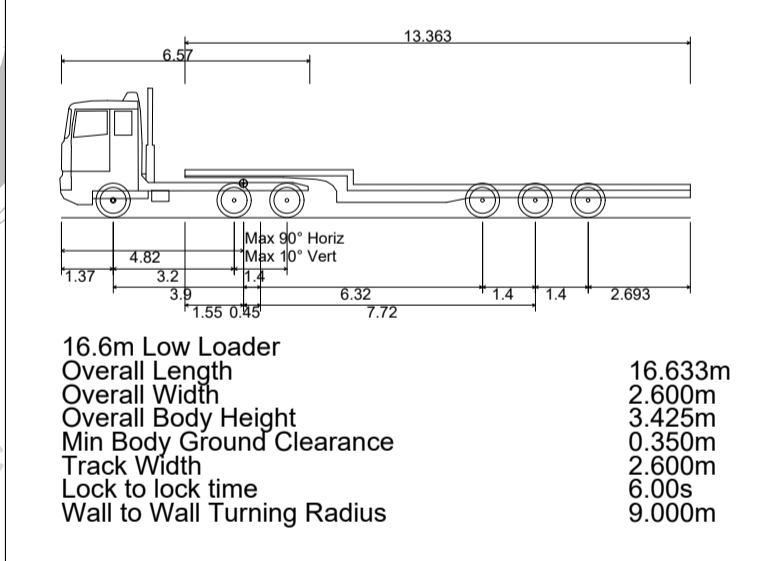
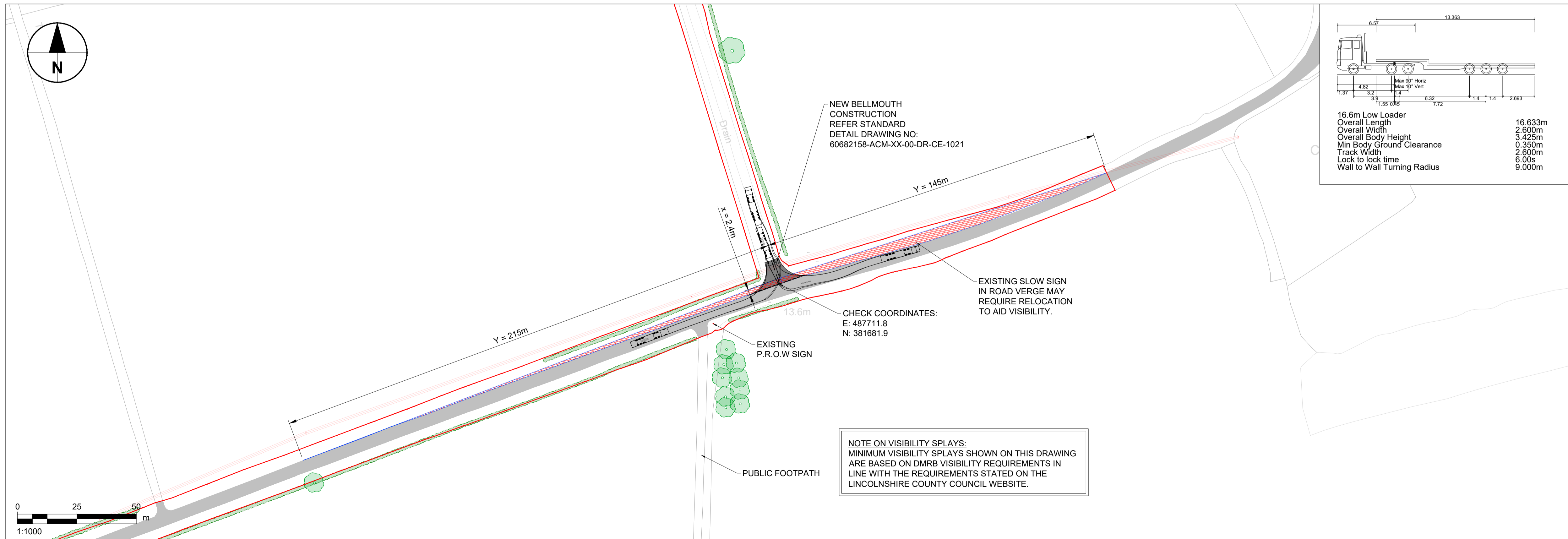
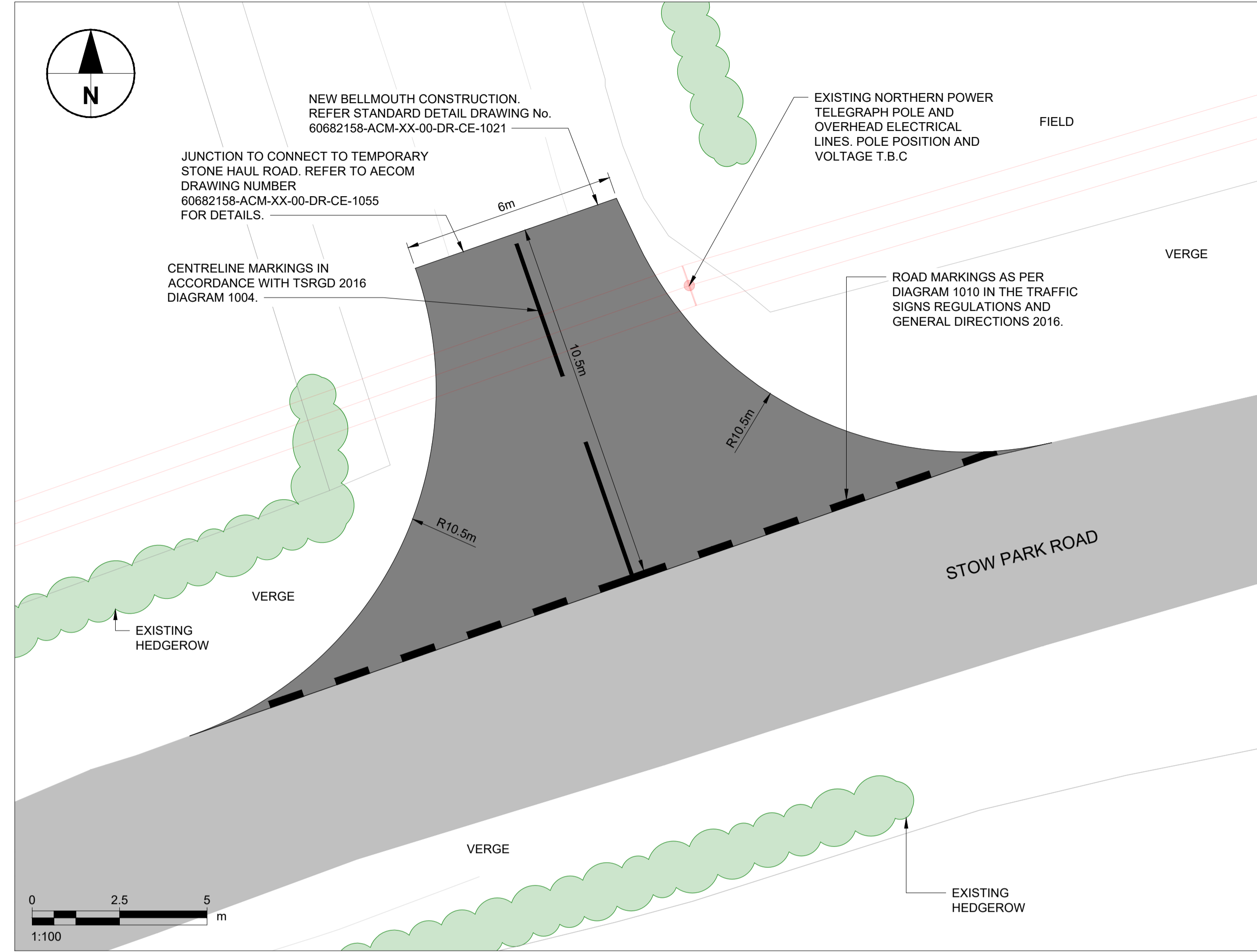
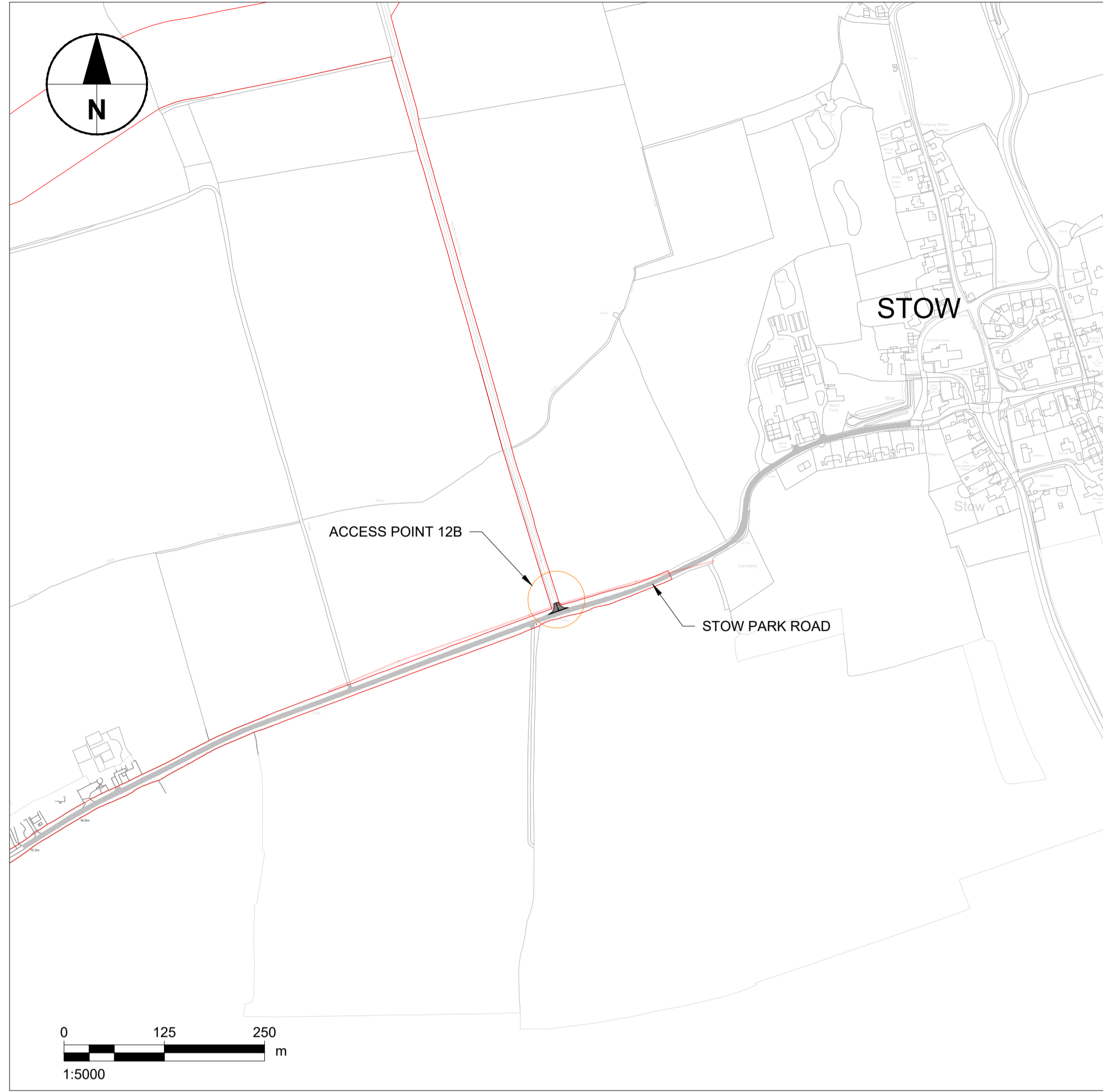

NOTE ON VISIBILITY SPLAYS:
 MINIMUM VISIBILITY SPLAYS SHOWN ON THIS DRAWING
 ARE BASED ON DMRB VISIBILITY REQUIREMENTS IN
 LINE WITH THE REQUIREMENTS STATED ON THE
 LINCOLNSHIRE COUNTY COUNCIL WEBSITE.

- Notes**
- ALL DIMENSIONS IN METRES UNLESS STATED OTHERWISE.
 - DO NOT SCALE FROM THIS DRAWING USE ONLY FIGURED DIMENSIONS.
 - VISIBILITY X DISTANCE IS BASED ON 2.4m WHICH IS A PERMITTED RELAXATION IN ACCORDANCE WITH CD 123 DOCUMENTATION SUBJECT TO APPROVAL BY THE LOCAL AUTHORITY.

- KEY:**
- EXISTING TREES / HEDGES / VEGETATION
 - VISIBILITY SPLAY
 - EXISTING BELLMOUTH TO BE RESURFACED AND WIDENED
 - DCO SUBMISSION ORDER LIMITS

ISSUE/REVISION

Rev	Date	Description	Drm/Chk/Appr
B	15.03.24	FINALISED FOR DCO SUBMISSION	EP/GMcE/CDY
A	08.09.23	VISIBILITY X DISTANCE AMENDED	GMcE/EP
-	21.08.23	FIRST ISSUE	MW/GMcE/EP

NOT FOR CONSTRUCTION
FOR INFORMATION ONLY

Purpose Of Issue
 DCO SUBMISSION

Project Number
 60682158

Sheet Title
 PROPOSED ACCESS POINT 12B
 (STOW PARK ROAD)

Sheet Number
 60682158-ACM-XX-00-DR-CE-1048

Scale: AS SHOWN @ A1 **Rev:** B

This drawing has been prepared for the use of AECOM's client. It may not be used, modified, reproduced or relied upon by third parties, except as agreed by AECOM or as required by law. AECOM accepts no responsibility, and denies any liability, whatsoever, to any party that uses or relies on this drawing without AECOM's express written consent. Do not scale this document. All measurements must be obtained from the stated dimensions.

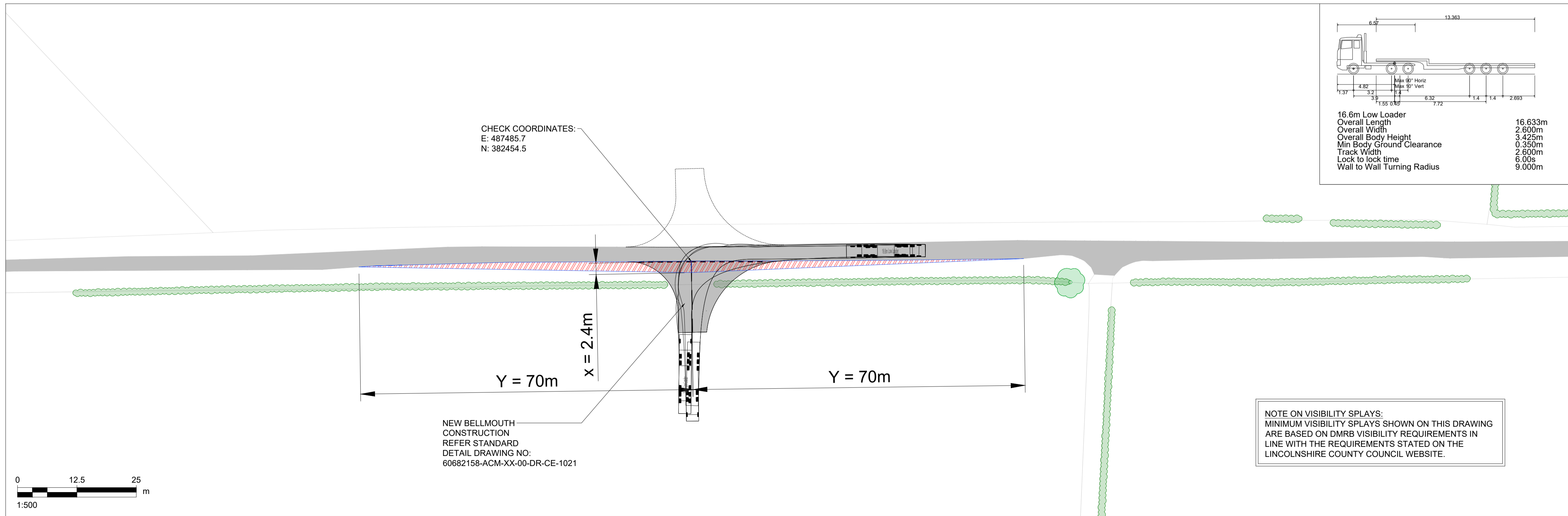
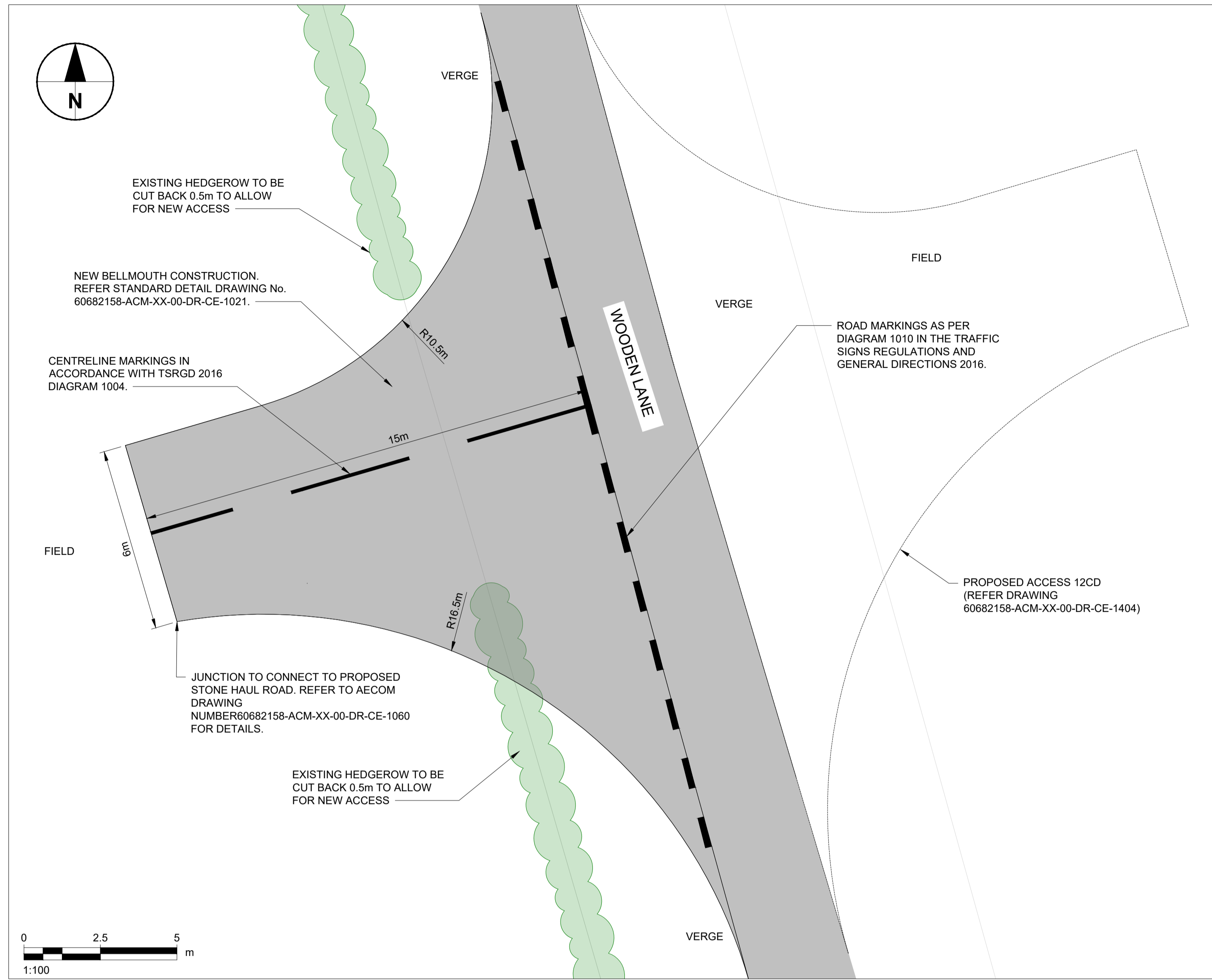

16.6m Low Loader	16.633m
Overall Length	2.600m
Overall Width	3.425m
Overall Body Height	0.350m
Min Body Ground Clearance	2.600m
Track Width	6.00s
Lock to lock time	9.000m
Wall to Wall Turning Radius	

NOTE ON VISIBILITY SPLAYS:
MINIMUM VISIBILITY SPLAYS SHOWN ON THIS DRAWING ARE BASED ON DMRS VISIBILITY REQUIREMENTS IN LINE WITH THE REQUIREMENTS STATED ON THE LINCOLNSHIRE COUNTY COUNCIL WEBSITE.

- Notes
1. ALL DIMENSIONS IN METRES UNLESS STATED OTHERWISE.
 2. DO NOT SCALE FROM THIS DRAWING USE ONLY FIGURED DIMENSIONS.
 3. VISIBILITY X DISTANCE IS BASED ON 2.4m WHICH IS A PERMITTED RELAXATION IN ACCORDANCE WITH CD123 DOCUMENTATION SUBJECT TO APPROVAL FROM LINCOLNSHIRE COUNTY COUNCIL.

KEY:

	EXISTING TREES / HEDGES / VEGETATION
	VISIBILITY SPLAY
	EXISTING BELLMOUTH TO BE RESURFACED
	EXISTING CARRIAGEWAY
	DCO SUBMISSION ORDER LIMITS

ISSUE/REVISION

Rev	Date	Description	Drm/Chk/Appr
B	15.03.24	FINALISED FOR DCO SUBMISSION	EP/GME/CGY
A	02.02.24	VISIBILITY SPLAYS AMENDED	GME/JM/CGY
-	02.01.24	FIRST ISSUE	GME/GME/EP

NOT FOR CONSTRUCTION
FOR INFORMATION ONLY

This drawing has been prepared for the use of AECOM's client. It may not be used, modified, reproduced or relied upon by third parties, except as agreed by AECOM or as required by law. AECOM accepts no responsibility, and denies any liability, whatsoever, to any party that uses or relies on this drawing without AECOM's express written consent. Do not scale this document. All measurements must be obtained from the stated dimensions.

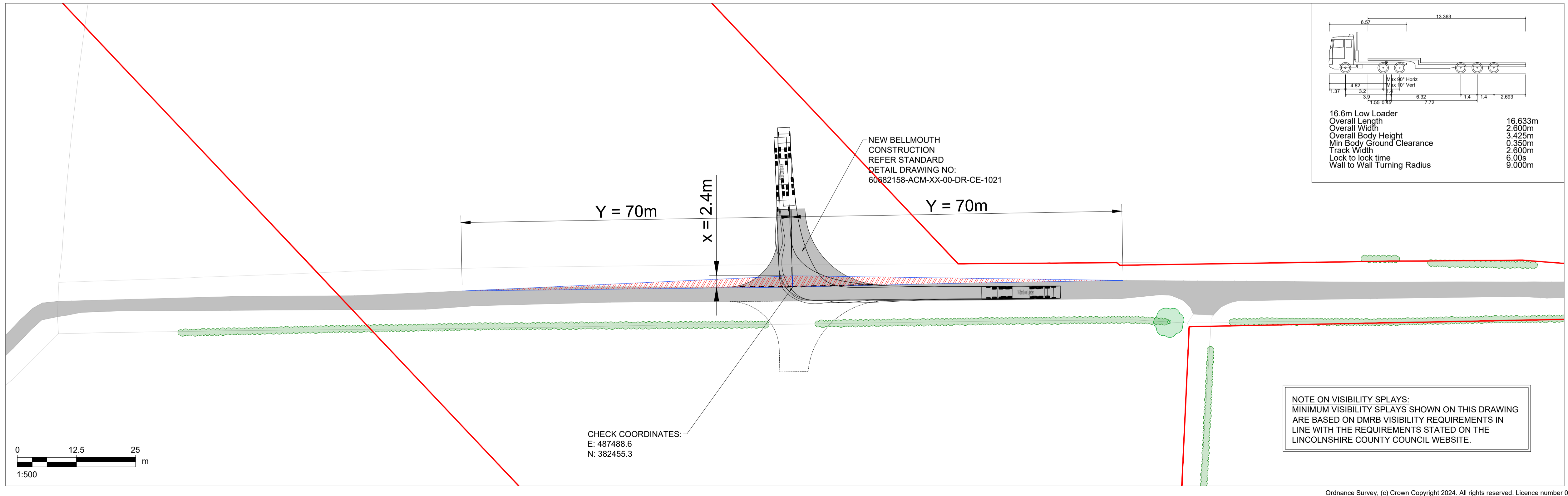
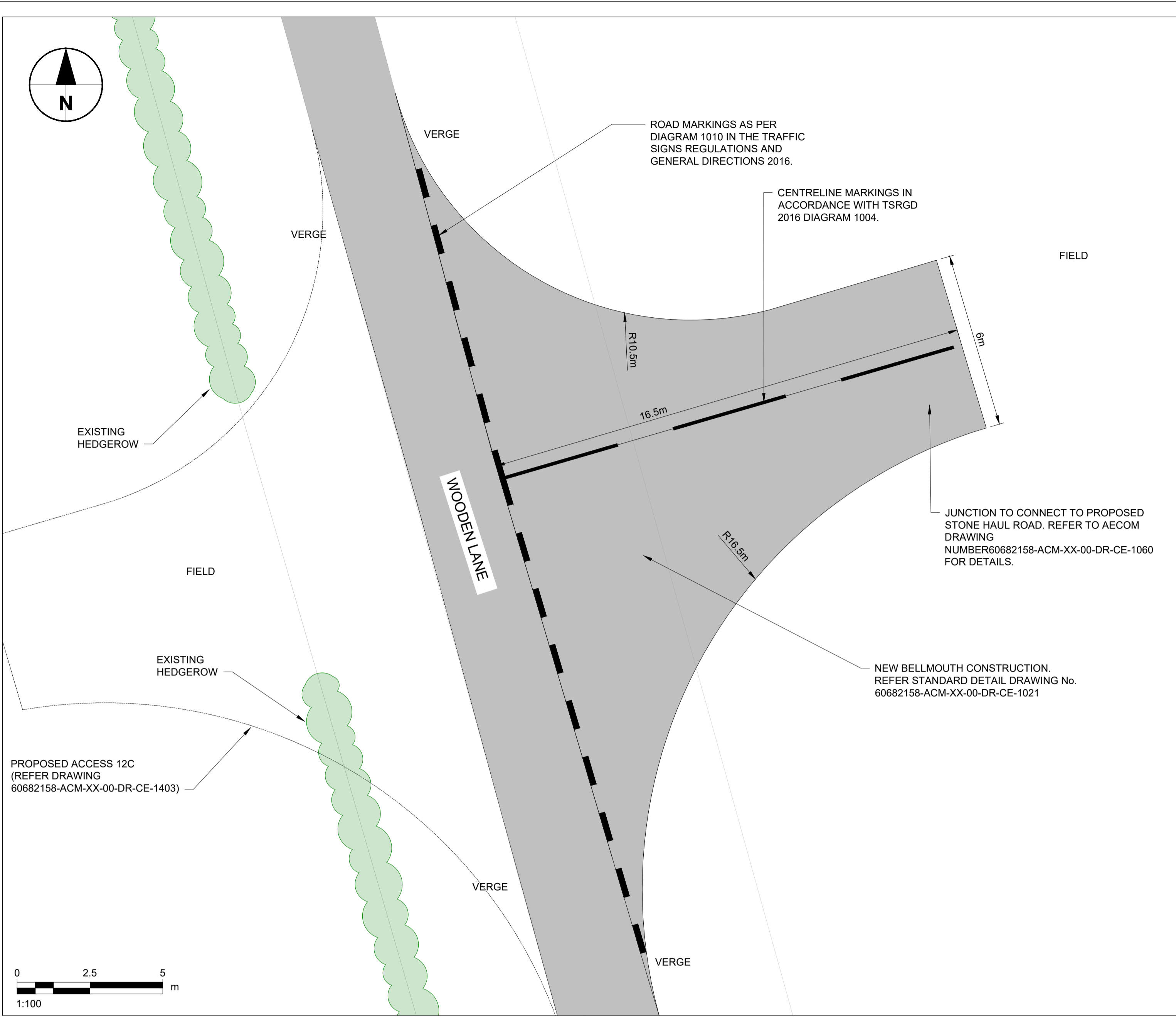
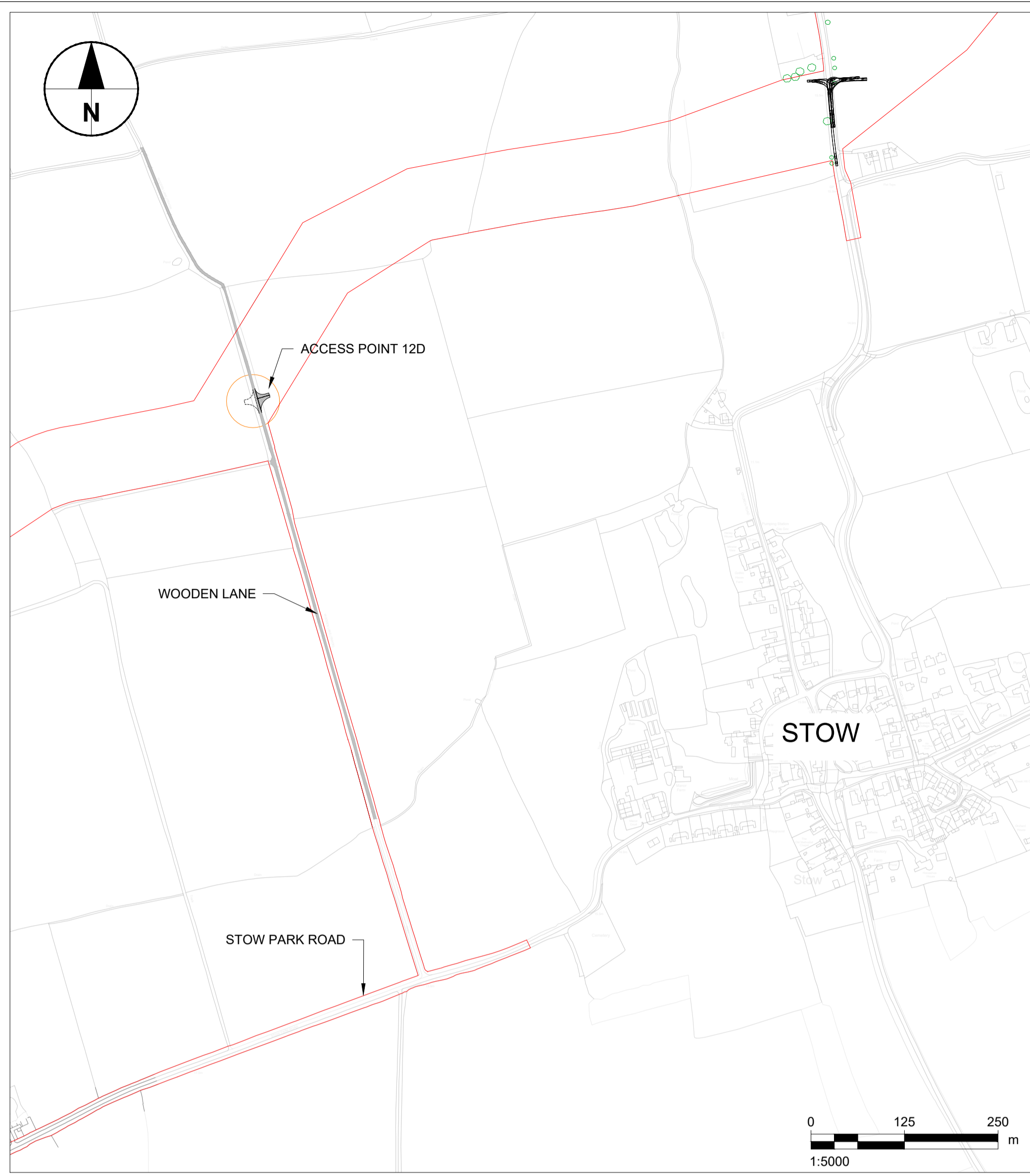

- Notes**
1. ALL DIMENSIONS IN METRES UNLESS STATED OTHERWISE.
 2. DO NOT SCALE FROM THIS DRAWING USE ONLY FIGURED DIMENSIONS.
 3. VISIBILITY X DISTANCE IS BASED ON 2.4m WHICH IS A PERMITTED RELAXATION IN ACCORDANCE WITH CD123 DOCUMENTATION SUBJECT TO APPROVAL FROM LINCOLNSHIRE COUNTY COUNCIL.

- KEY:**
- EXISTING TREES / HEDGES / VEGETATION
 - VISIBILITY SPLAY
 - EXISTING BELLMOUTH TO BE RESURFACED
 - EXISTING CARRIAGEWAY
 - DCO SUBMISSION ORDER LIMITS

ISSUE/REVISION

Rev	Date	Description	Drm/Chk/Appr
B	15.03.24	FINALISED FOR DCO SUBMISSION	EPI/GME/CGY
A	02.02.24	VISIBILITY SPLAYS AMENDED	GME/JM/CGY
-	02.01.24	FIRST ISSUE	GME/GME/EP

NOT FOR CONSTRUCTION
FOR INFORMATION ONLY

Purpose Of Issue
DCO SUBMISSION

Project Number
60682158

Sheet Title
PROPOSED ACCESS POINT 12D
(WOODEN LANE)

Sheet Number
60682158-ACM-XX-00-DR-CE-1404

Scale: AS SHOWN @ A1 **Rev: B**

This drawing has been prepared for the use of AECOM's client. It may not be used, modified, reproduced or relied upon by third parties, except as agreed by AECOM or as required by law. AECOM accepts no responsibility, and denies any liability, whatsoever, to any party that uses or relies on this drawing without AECOM's express written consent. Do not scale this document. All measurements must be obtained from the stated dimensions.

KEY:

- DCO SUBMISSION ORDER LIMITS
- EXISTING TREES
- EXISTING HEDGEROW / VEGETATION
- VISIBILITY SPY
- NEW SURFACED BELLMOUTH
- EXISTING CARRIAGEWAY

ISSUE/REVISION

Rev	Date	Description	Dwn/Chk/Appr
D	15.03.24	FINALISED FOR DCO SUBMISSION	GM/G&E/CDY
C	20.10.23	MINOR AMENDMENTS	GM/G&E/EP
B	18.09.23	JUNCTION MOVED TO SUIT NEW CABLE ROUTE	GM/G&E/CDY
A	08.09.23	VISIBILITY X DISTANCE AMENDED	GM/G&E/EP
-	23.08.23	FIRST ISSUE	MM/G&E/EP

NOT FOR CONSTRUCTION
FOR INFORMATION ONLY

Purpose Of Issue
 DCO SUBMISSION

Project Number
 60682158

Sheet Title
 PROPOSED ACCESS POINT 13
 (NORMANBY ROAD HEADING WEST)

Sheet Number
 60682158-ACM-XX-00-DR-CE-1039

Scale: AS SHOWN @ A1 **Rev:** D

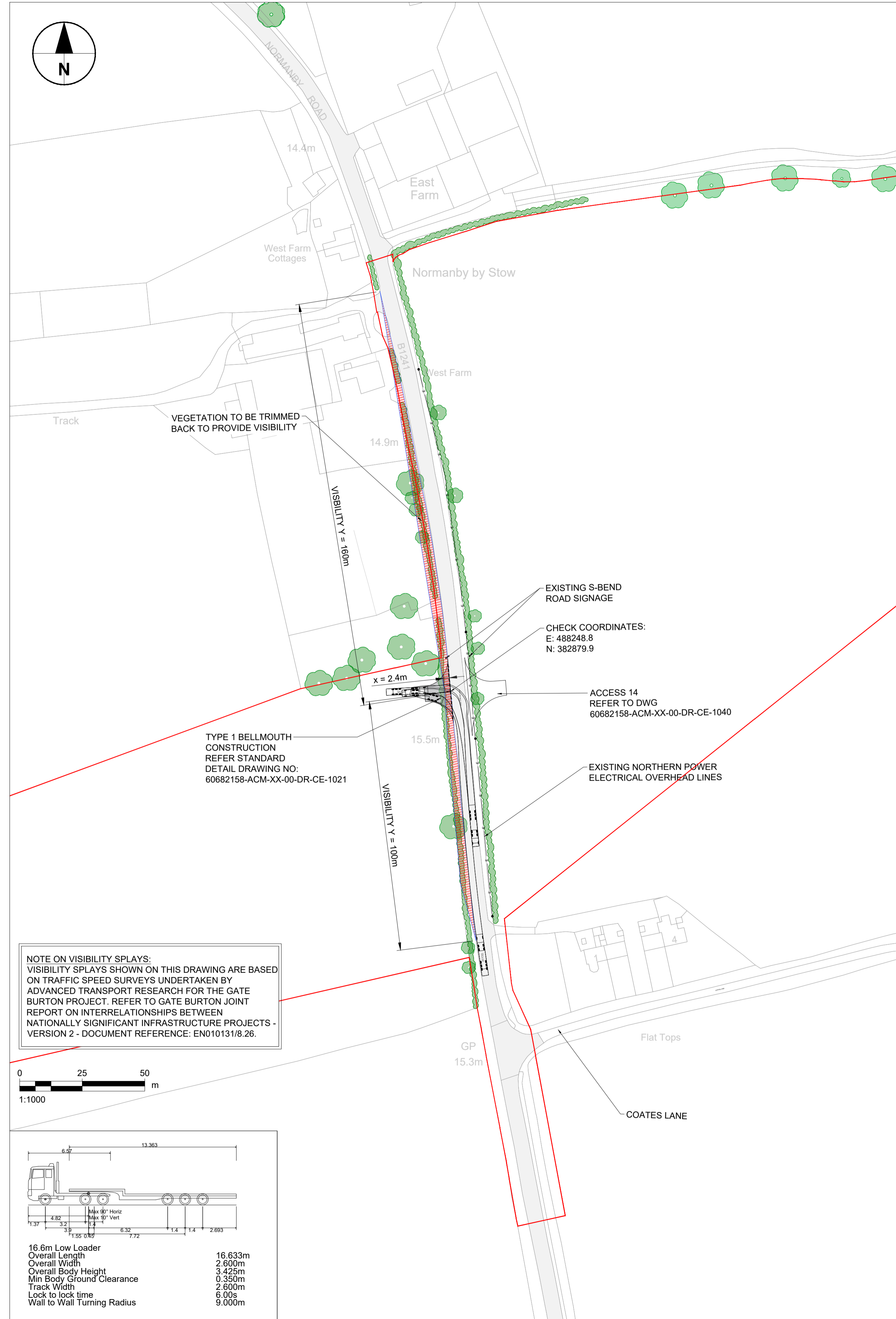
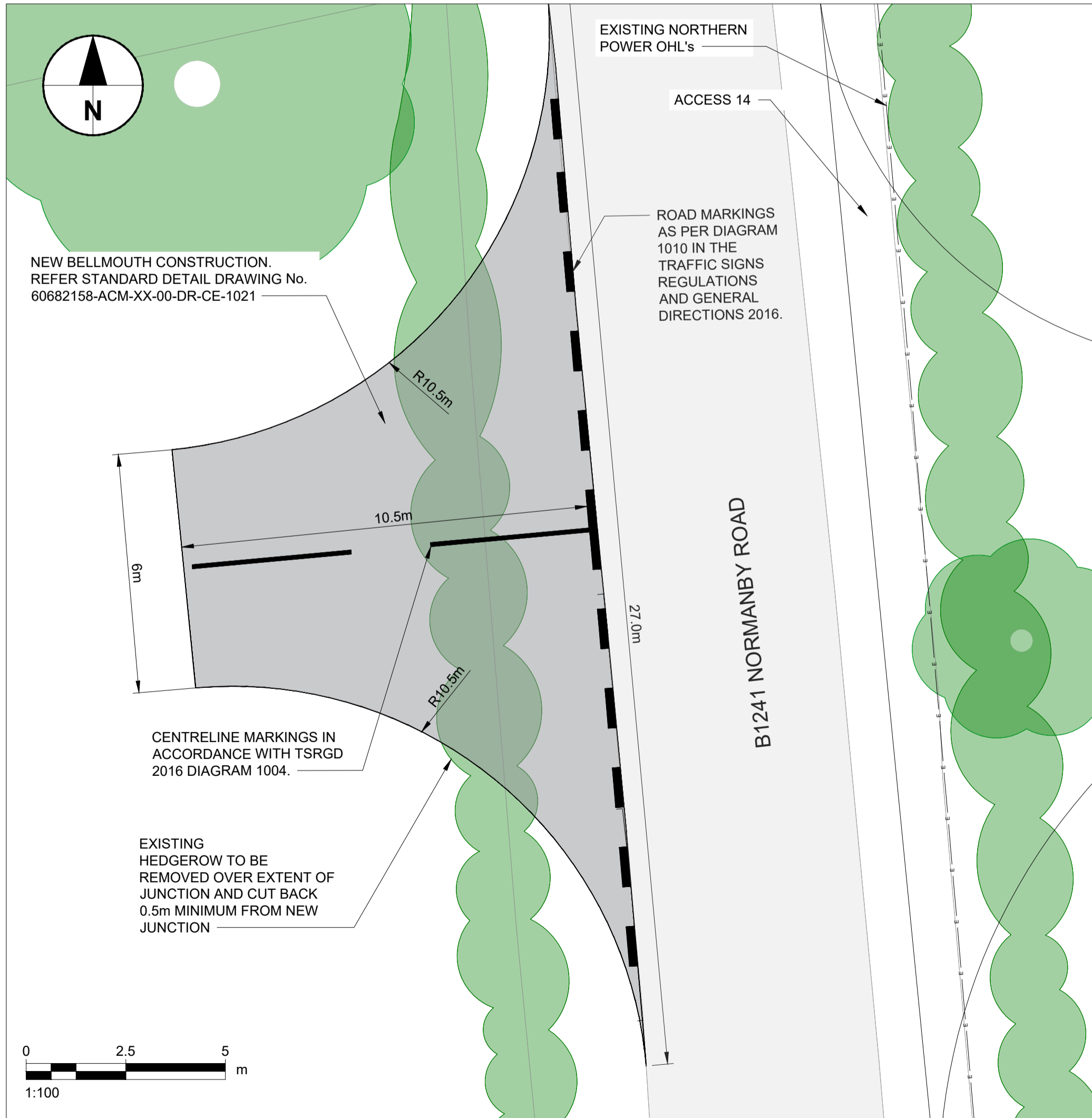
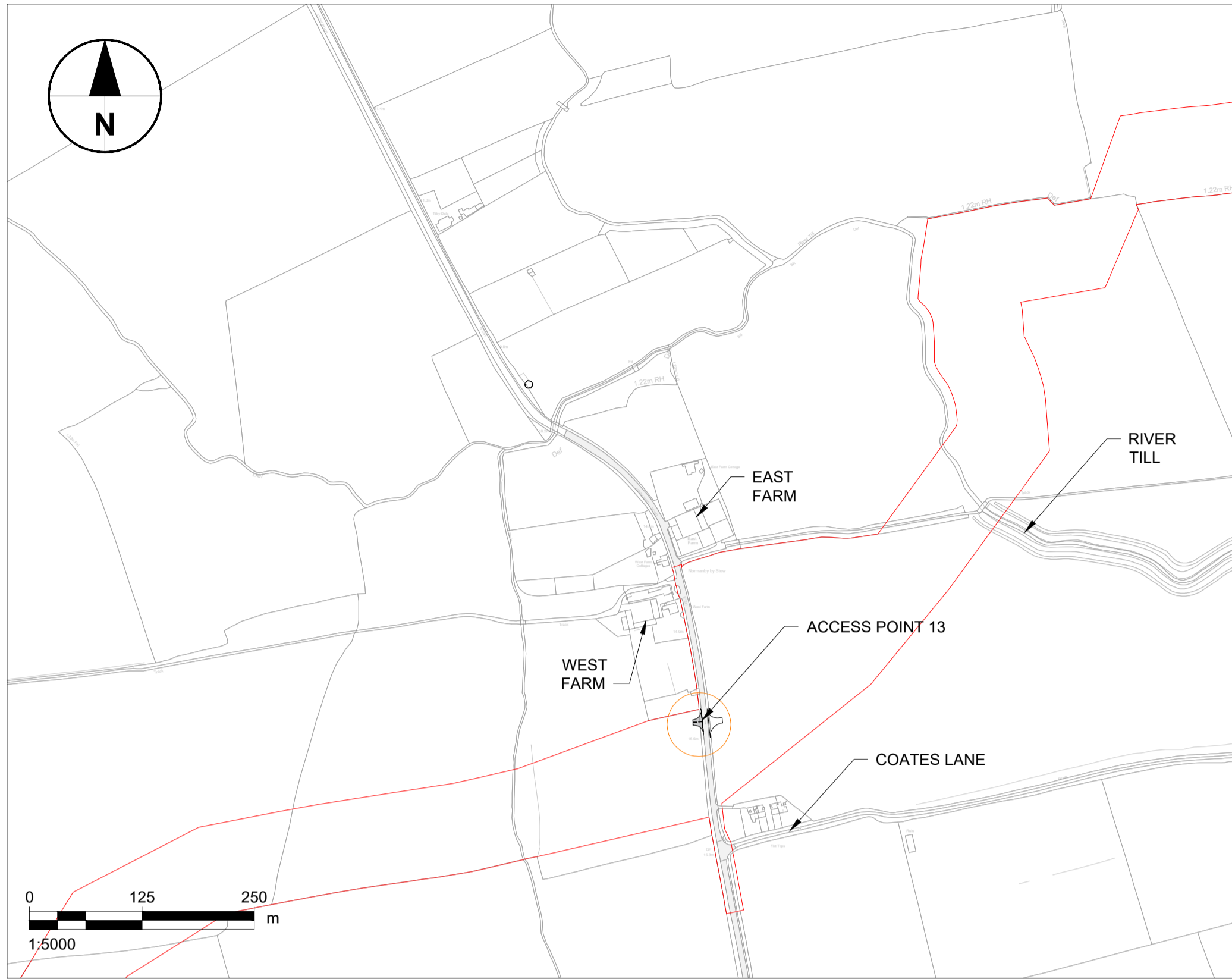

NOTE ON VISIBILITY SPLAYS:
 VISIBILITY SPLAYS SHOWN ON THIS DRAWING ARE BASED ON TRAFFIC SPEED SURVEYS UNDERTAKEN BY ADVANCED TRANSPORT RESEARCH FOR THE GATE BURTON PROJECT. REFER TO GATE BURTON JOINT REPORT ON INTERRELATIONSHIPS BETWEEN NATIONALLY SIGNIFICANT INFRASTRUCTURE PROJECTS - VERSION 2 - DOCUMENT REFERENCE: EN010131/8.26.

KEY:

- DCO SUBMISSION ORDER LIMITS
- EXISTING TREES
- EXISTING HEDGEROW / VEGETATION
- VISIBILITY SPLAY
- NEW SURFACED BELLMOUTH
- EXISTING CARRIAGEWAY

ISSUE/REVISION

Rev	Date	Description	Drm/Chk/Appr
D	15.03.24	FINALISED FOR DCO SUBMISSION	GM/GAE/CDY
C	06.12.23	MINOR AMENDMENTS	GM/EJ/M/CGY
B	18.09.23	JUNCTION MOVED TO SUIT NEW CABLE ROUTE	GM/GAE/CDY
A	08.09.23	VISIBILITY X DISTANCE AMENDED	GM/GAE/EP
-	23.08.24	FIRST ISSUE	MM/GAE/EP

NOT FOR CONSTRUCTION
FOR INFORMATION ONLY

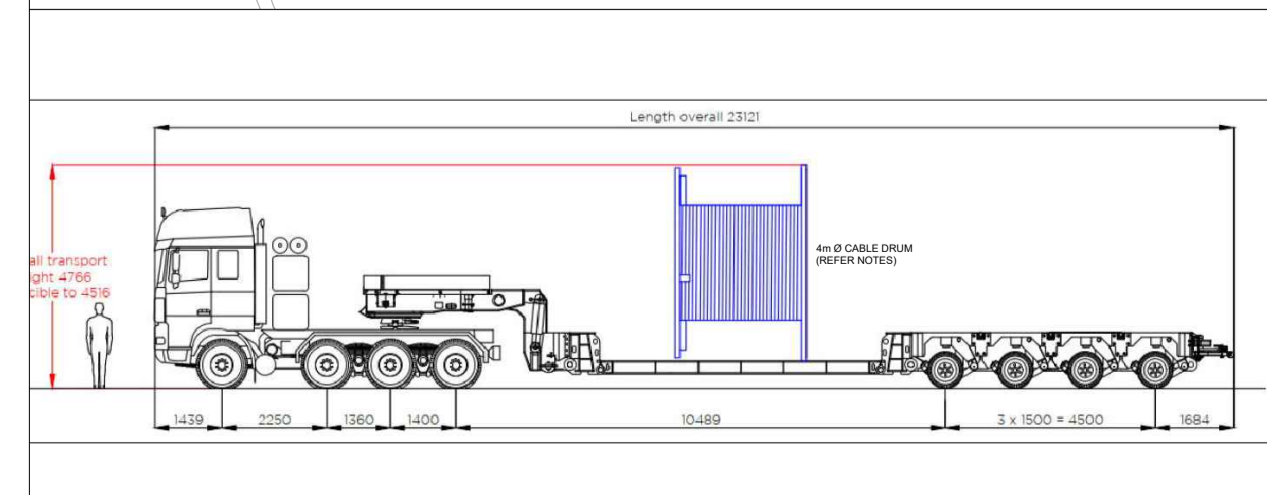
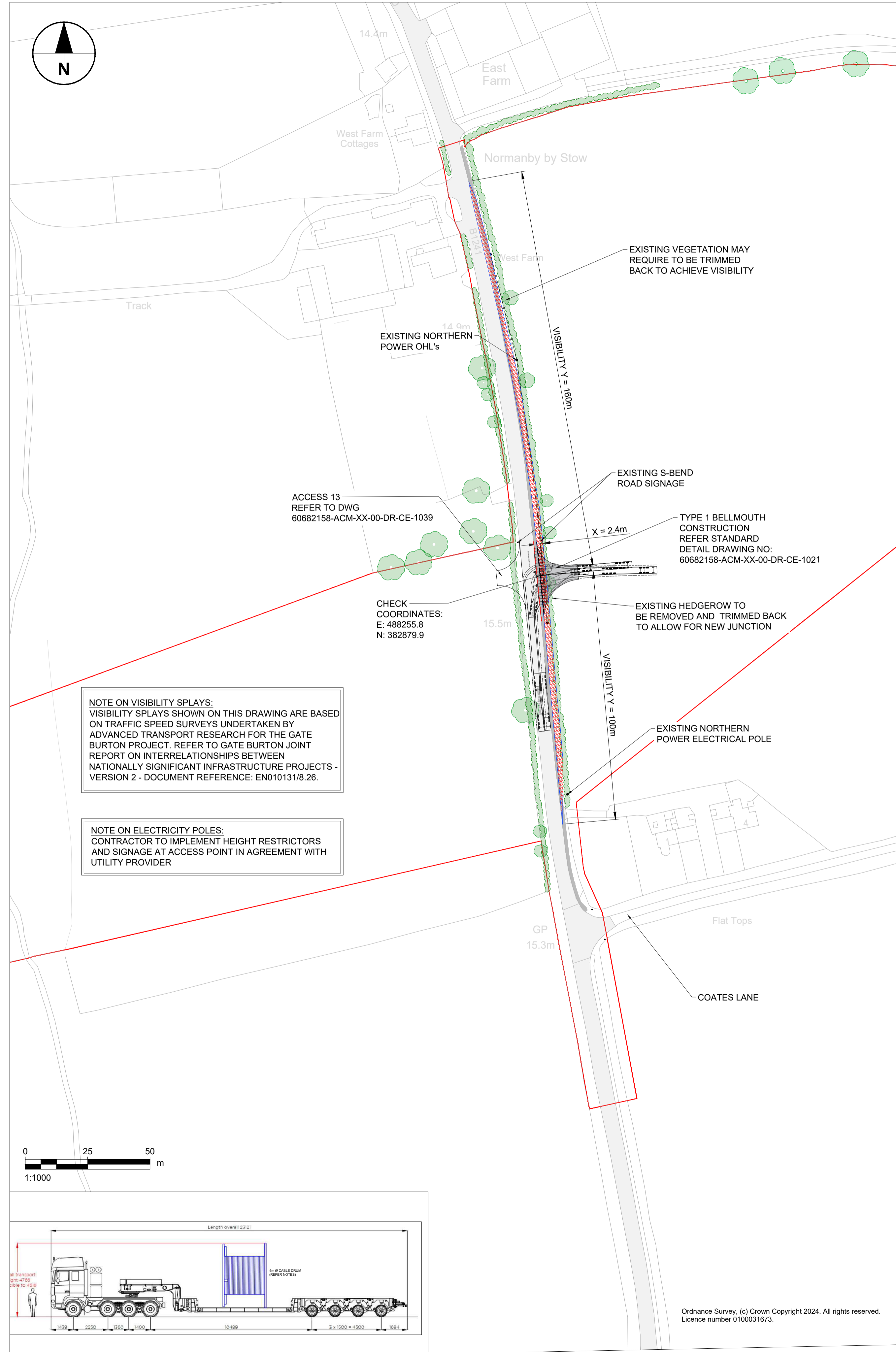
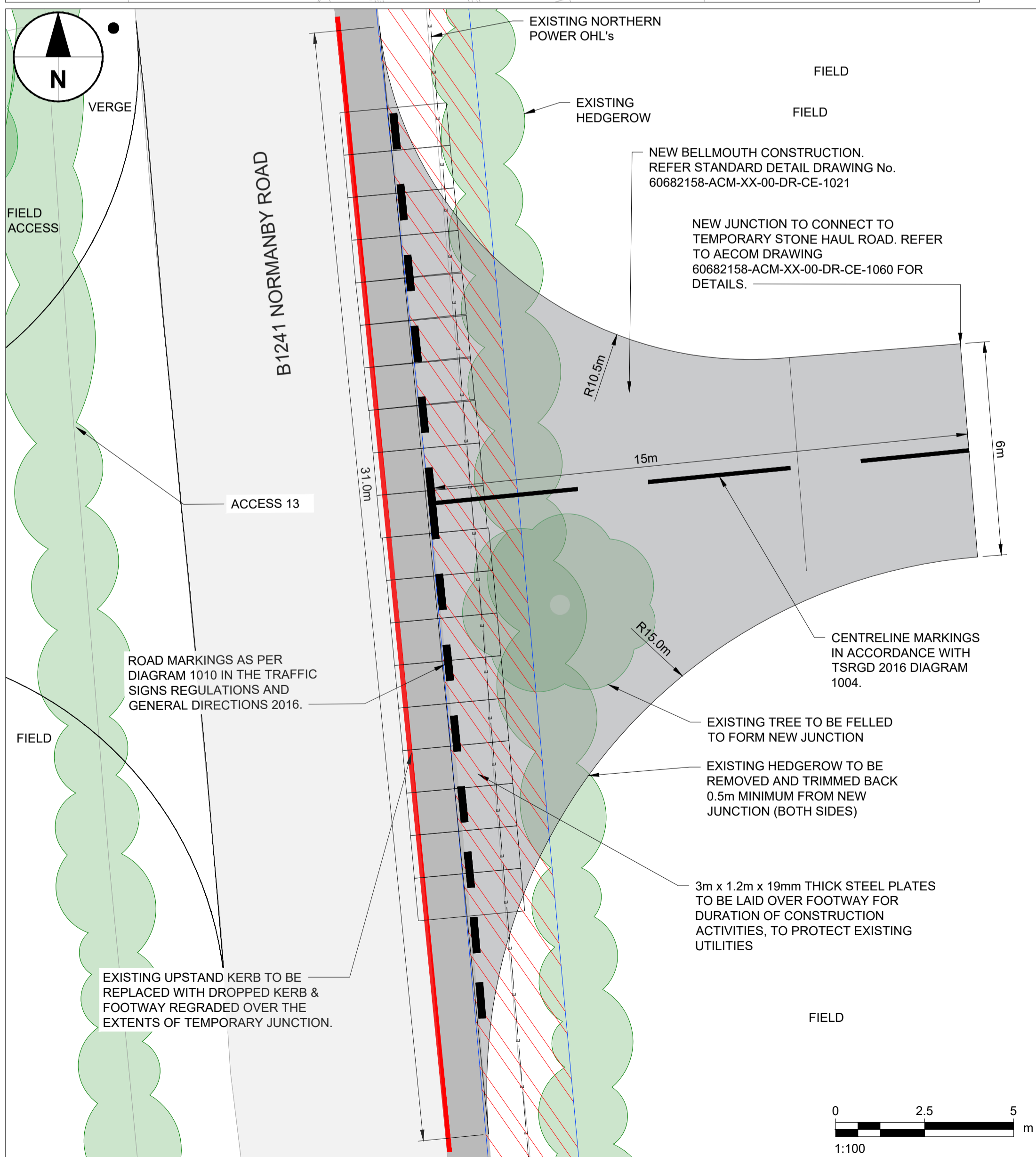
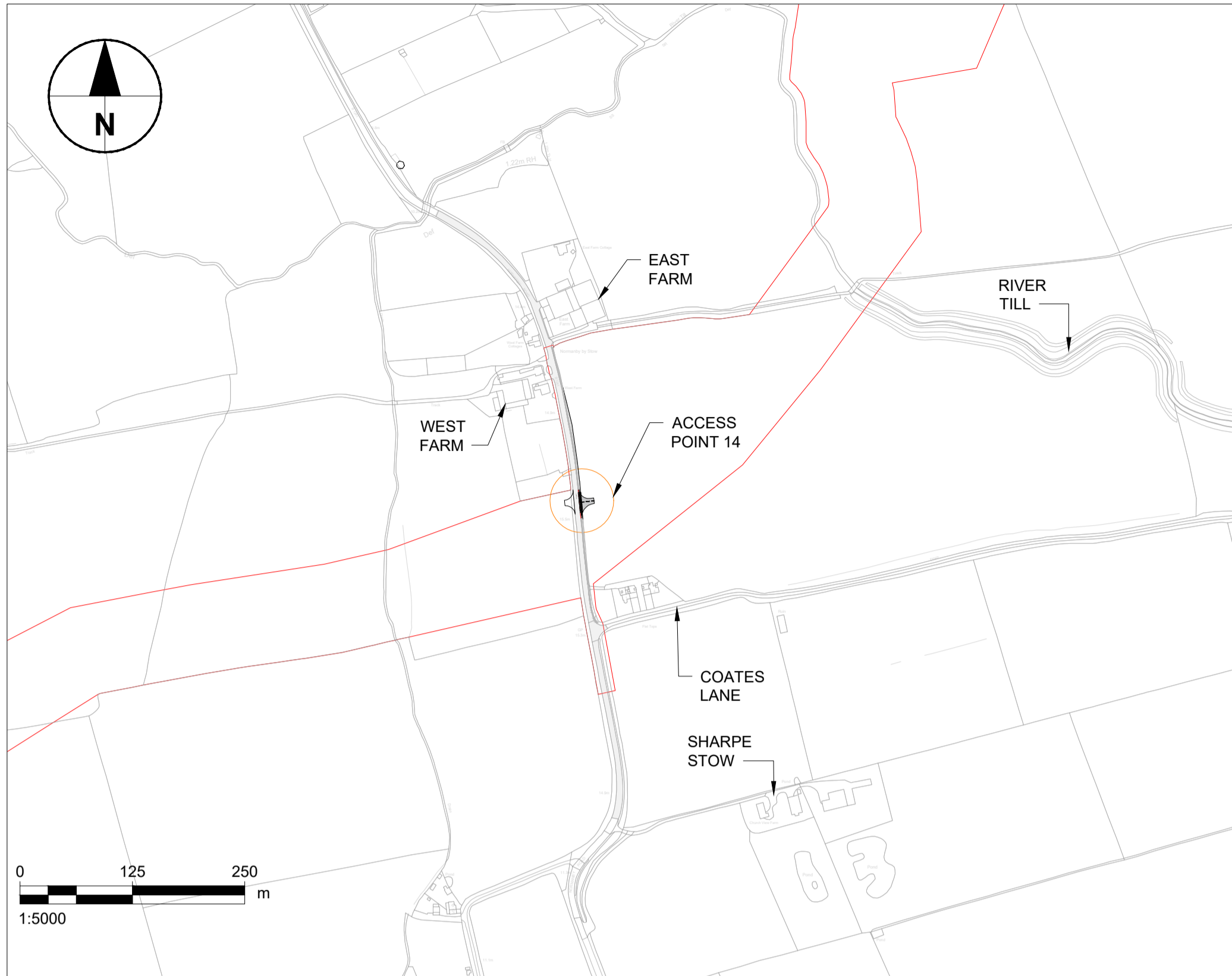

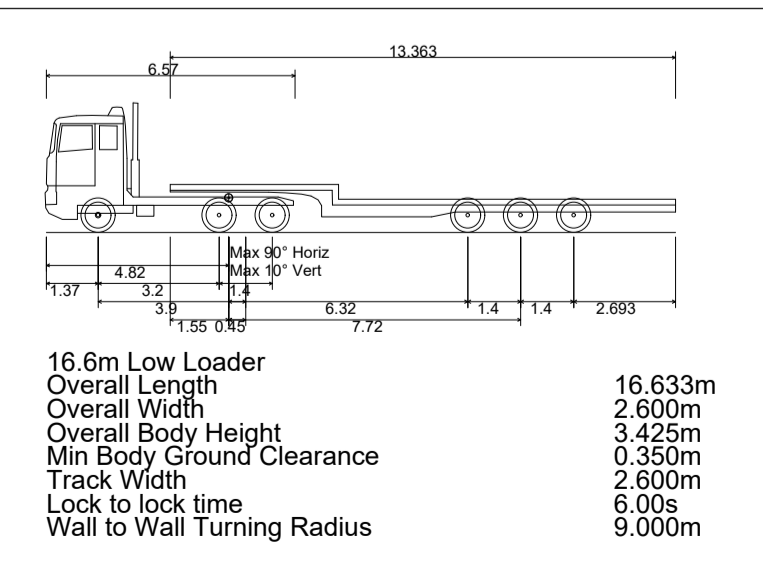
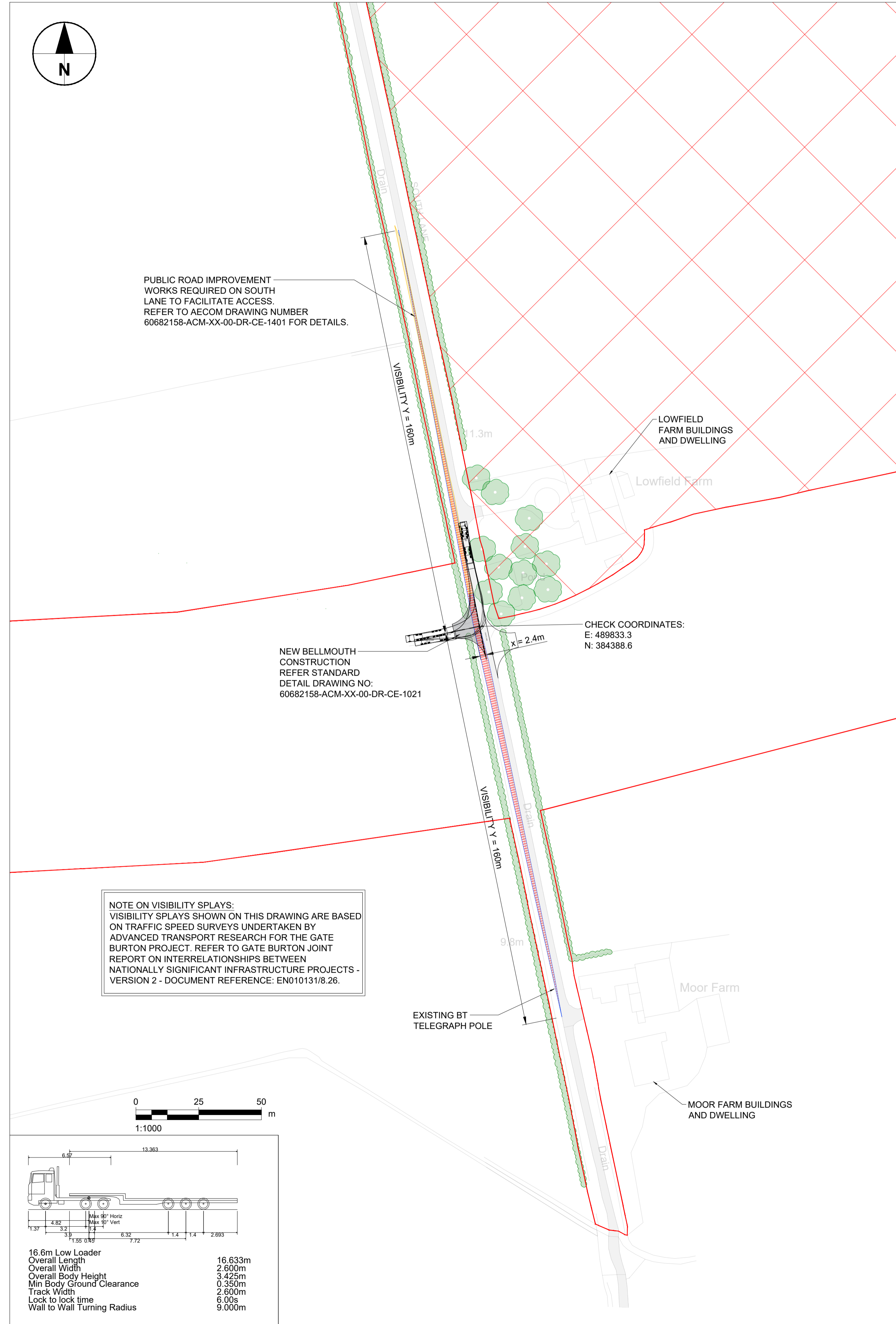
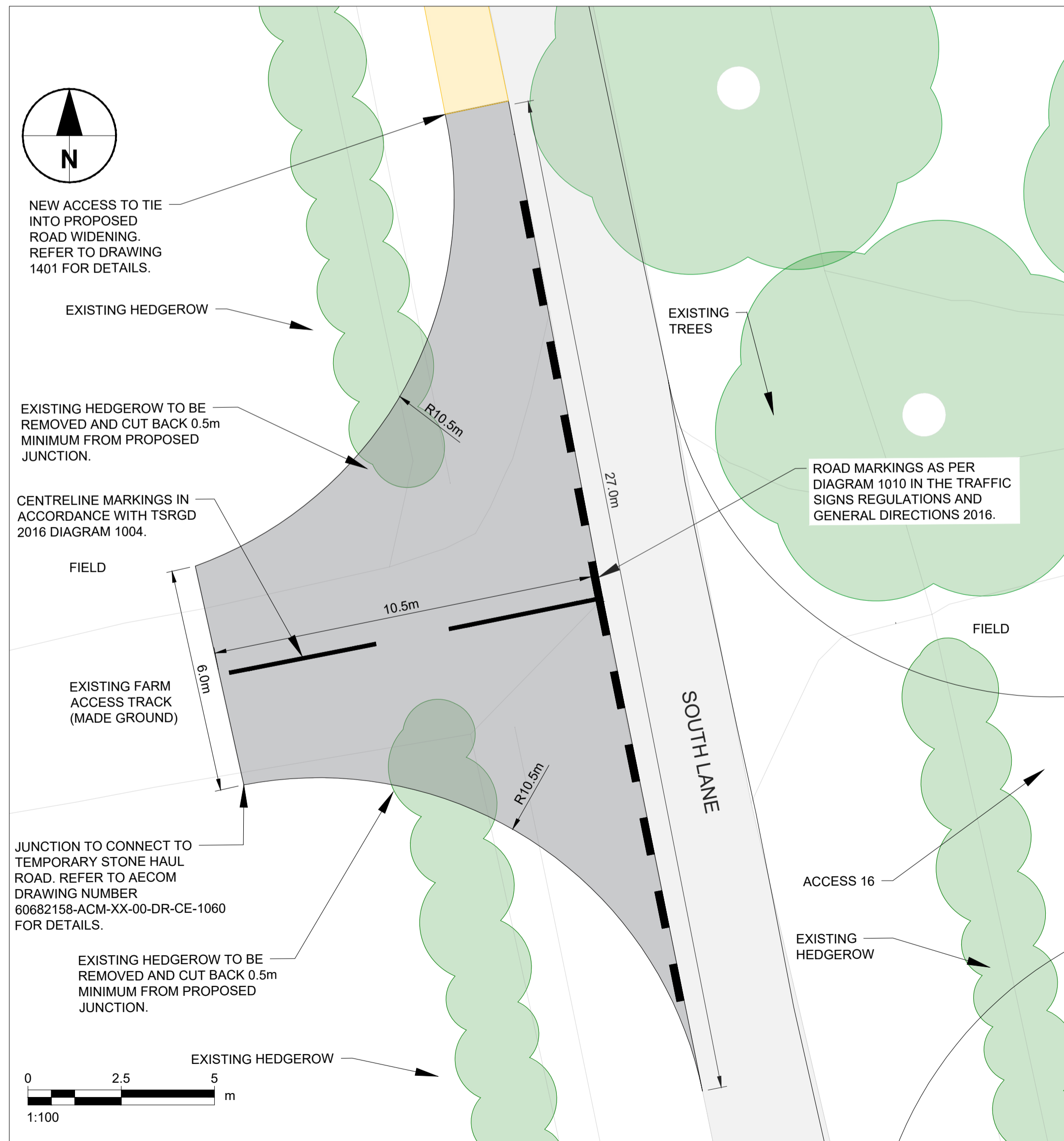
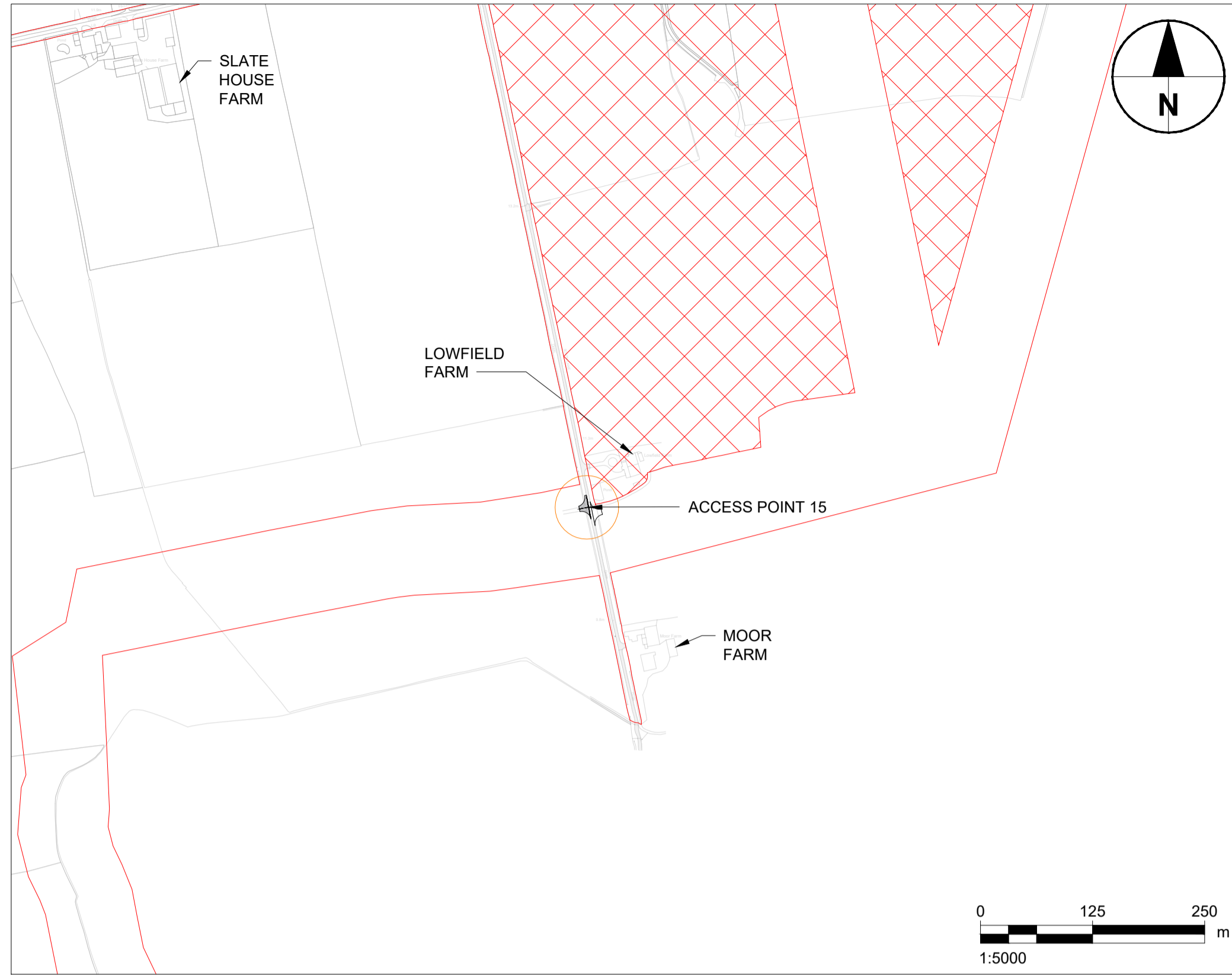

KEY:

- DCO SUBMISSION ORDER LIMITS
- EXISTING TREES
- EXISTING HEDGEROW / VEGETATION
- VISIBILITY SPLAY
- EXISTING BELLMOUTH TO BE RESURFACED
- EXISTING CARRIAGEWAY
- PROPOSED ROAD WIDENING REFER TO DRAWING 1401 FOR DETAILS.

ISSUE/REVISION

Rev	Date	Description	Dwn/Chk/Appr
C	15.03.24	FINALISED FOR DCO SUBMISSION	GM/GMcE/CGY
B	06.12.23	MINOR AMENDMENTS	GM/EJ/MCGY
A	08.09.23	VISIBILITY X DISTANCE AMENDED	GM/GMcE/EP
-	23.08.23	FIRST ISSUE	MM/GMcE/EP

NOT FOR CONSTRUCTION
FOR INFORMATION ONLY

This drawing has been prepared for the use of AECOM's client. It may not be used, modified, reproduced or relied upon by third parties, except as agreed by AECOM or as required by law. AECOM accepts no responsibility, and denies any liability whatsoever, to any party that uses or relies on this drawing without AECOM's express written consent. Do not scale this document. All measurements must be obtained from the stated dimensions.

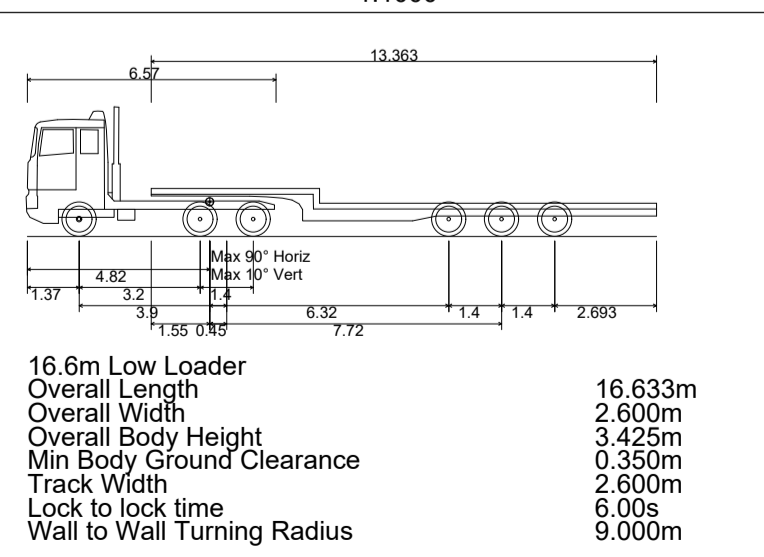
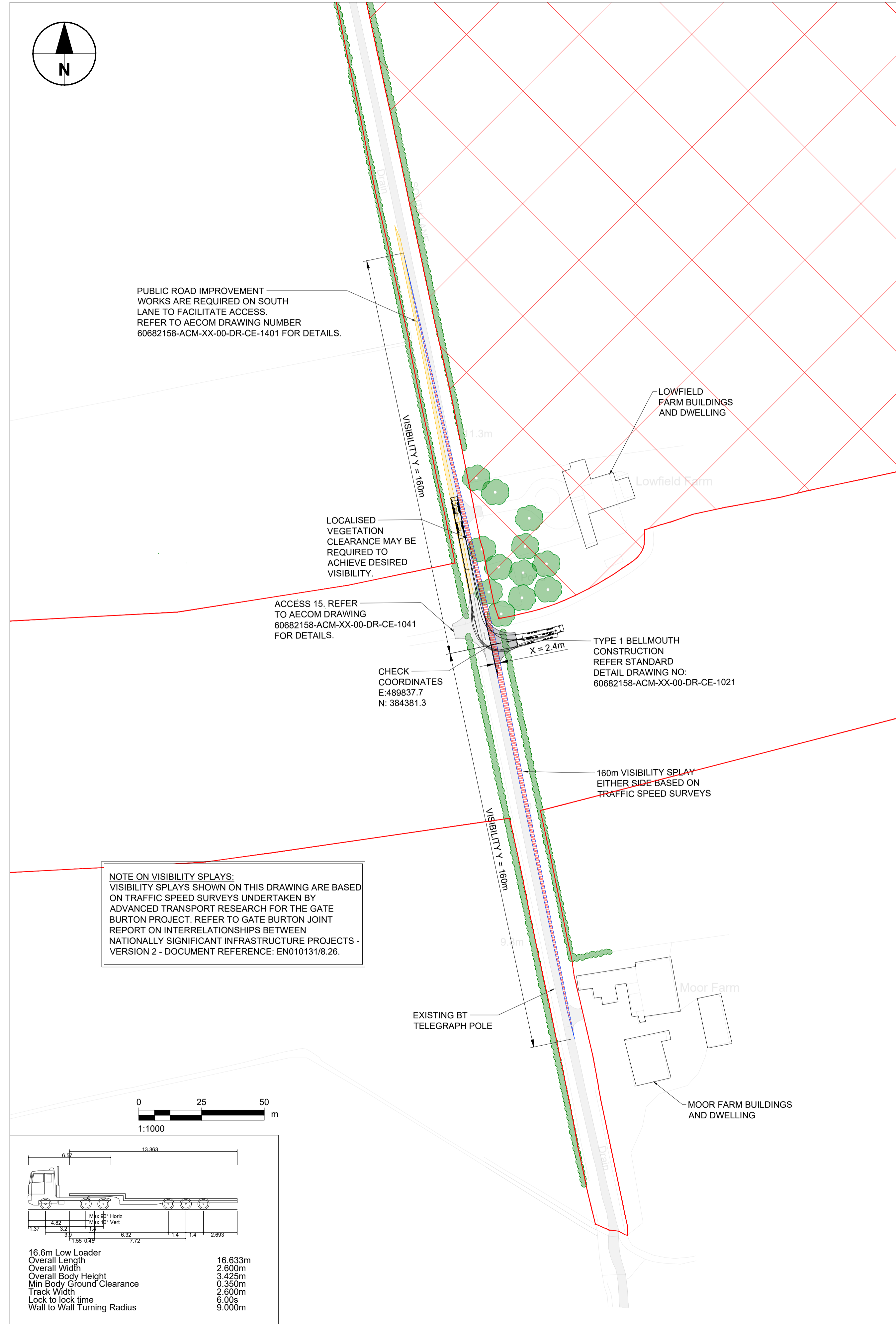
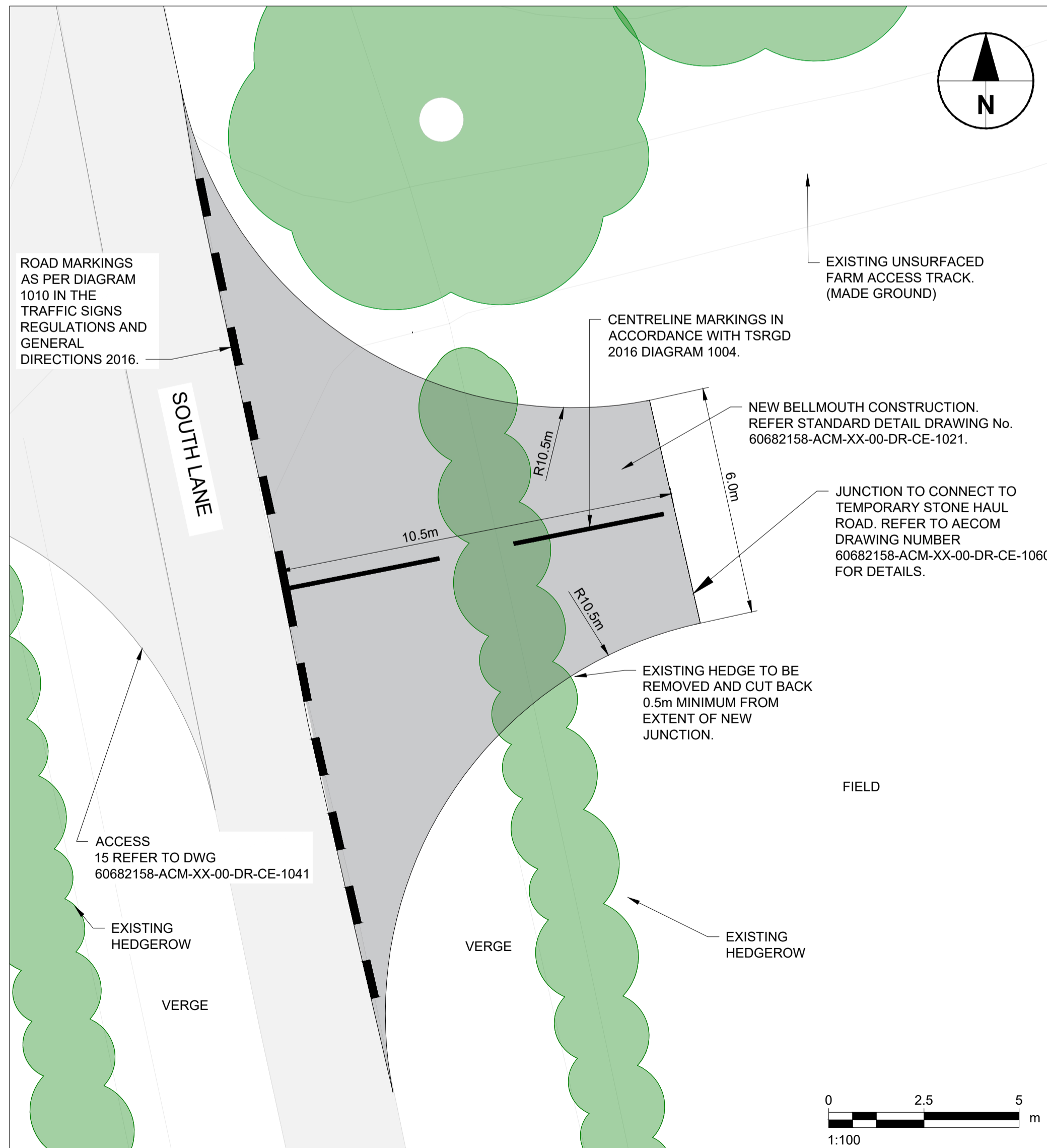
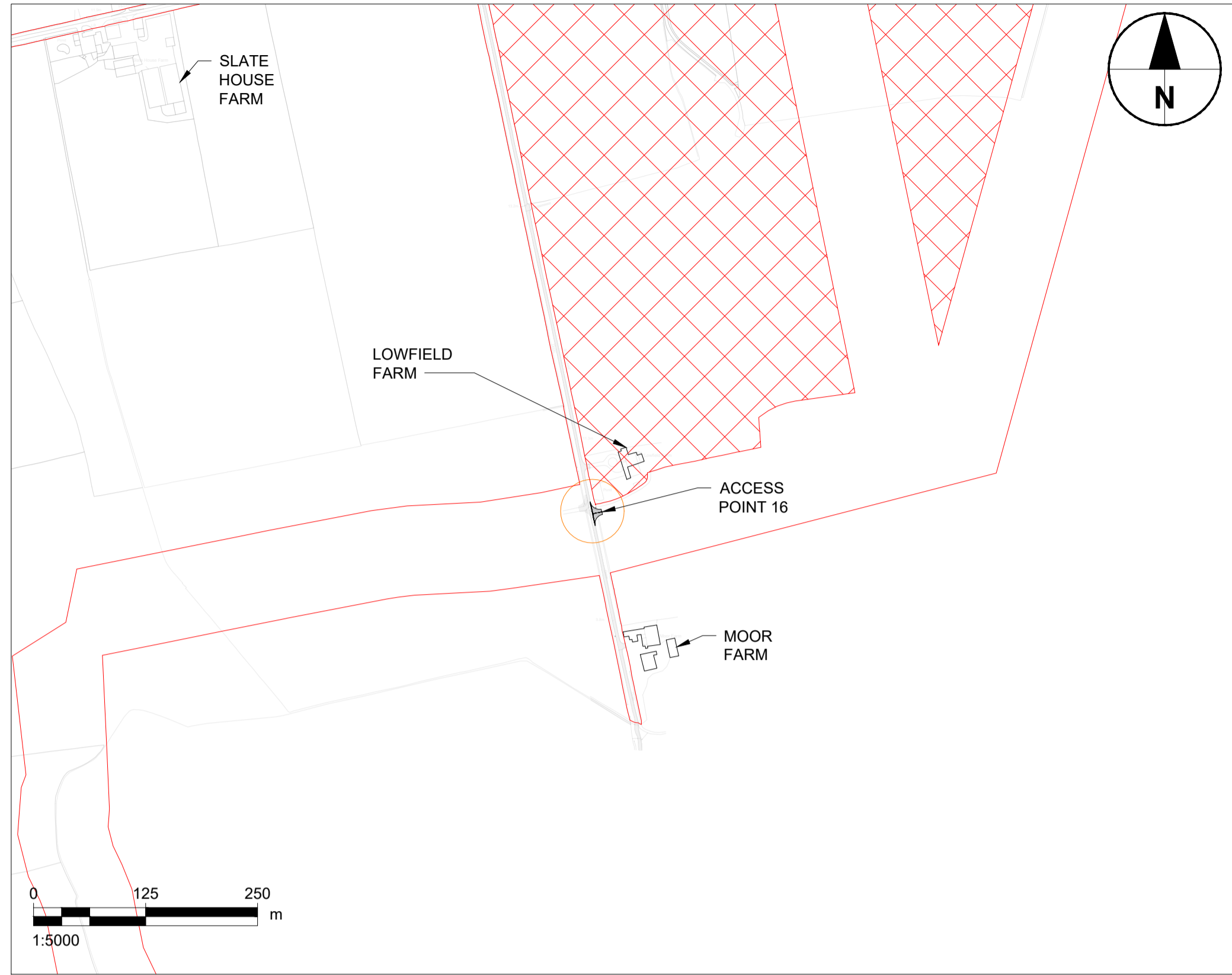

- Notes
- ALL DIMENSIONS IN METRES UNLESS STATED OTHERWISE. DO NOT SCALE FROM THIS DRAWING USE WRITTEN FIGURED DIMENSIONS.
 - VISIBILITY X DISTANCE IS BASED ON 2.4m WHICH IS A PERMITTED RELAXATION IN ACCORDANCE WITH CD123 DOCUMENTATION SUBJECT TO APPROVAL FROM LINCOLNSHIRE COUNTY COUNCIL.

KEY:

- DCO SUBMISSION ORDER LIMITS
- EXISTING TREES
- EXISTING HEDGEROW / VEGETATION
- VISIBILITY SPLAY
- NEW SURFACED BELLMOUTH
- EXISTING CARRIAGEWAY
- PROPOSED ROAD WIDENING REFER TO DRAWING 1401 FOR DETAILS.

ISSUE/REVISION

Rev	Date	Description	Dwn/Chk/Appr
C	15.03.24	FINALISED FOR DCO SUBMISSION	GM/GMcE/CGY
B	06.12.23	MINOR AMENDMENTS	GM/EJM/CGY
A	08.09.23	VISIBILITY X DISTANCE AMENDED	GM/GMcE/EP
-	23.08.23	FIRST ISSUE	MM/GMcE/EP

NOT FOR CONSTRUCTION
FOR INFORMATION ONLY

This drawing has been prepared for the use of AECOM's client. It may not be used, modified, reproduced or relied upon by third parties, except as agreed by AECOM or as required by law. AECOM accepts no responsibility, and denies any liability whatsoever, to any party that uses or relies on this drawing without AECOM's express written consent. Do not scale this document. All measurements must be obtained from the stated dimensions.

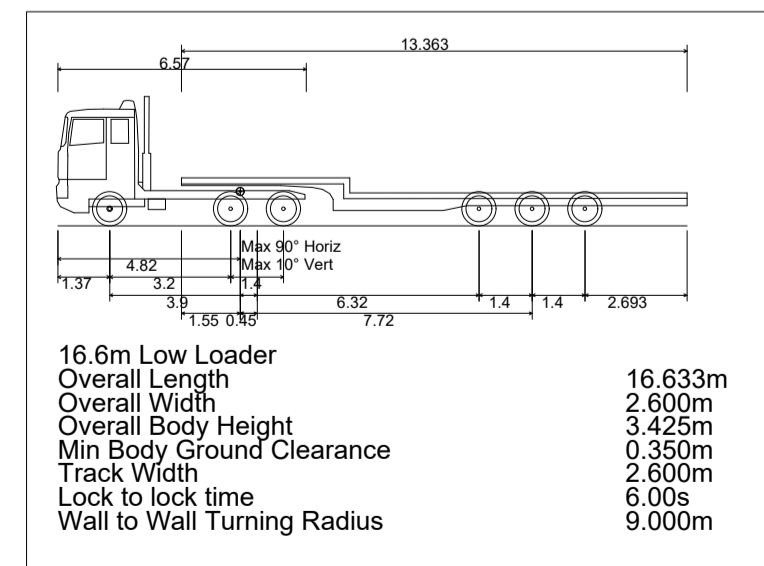
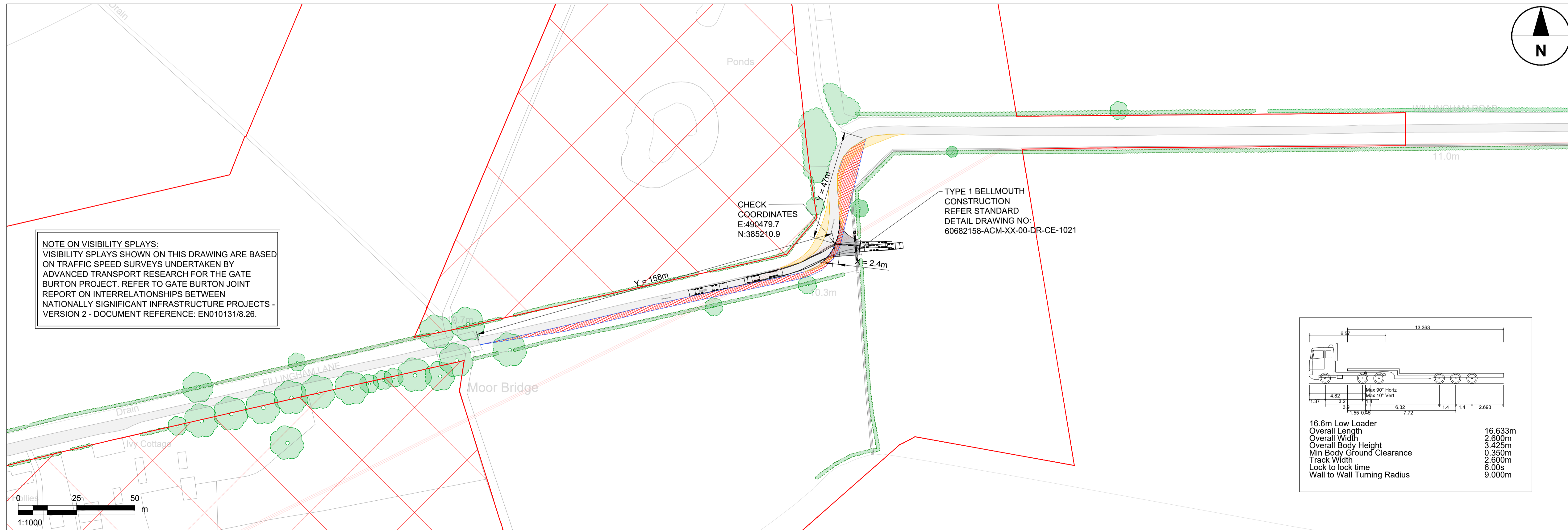
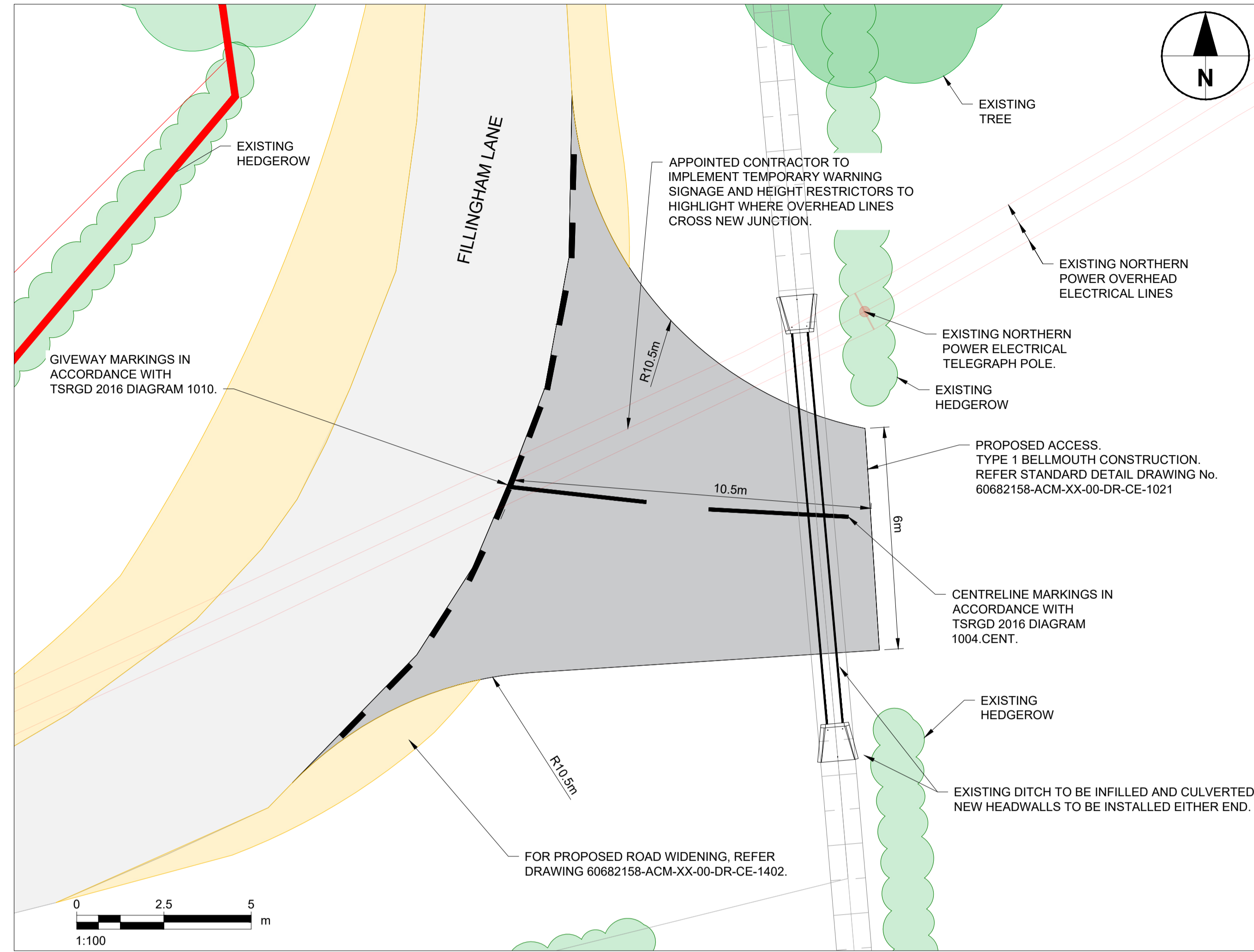
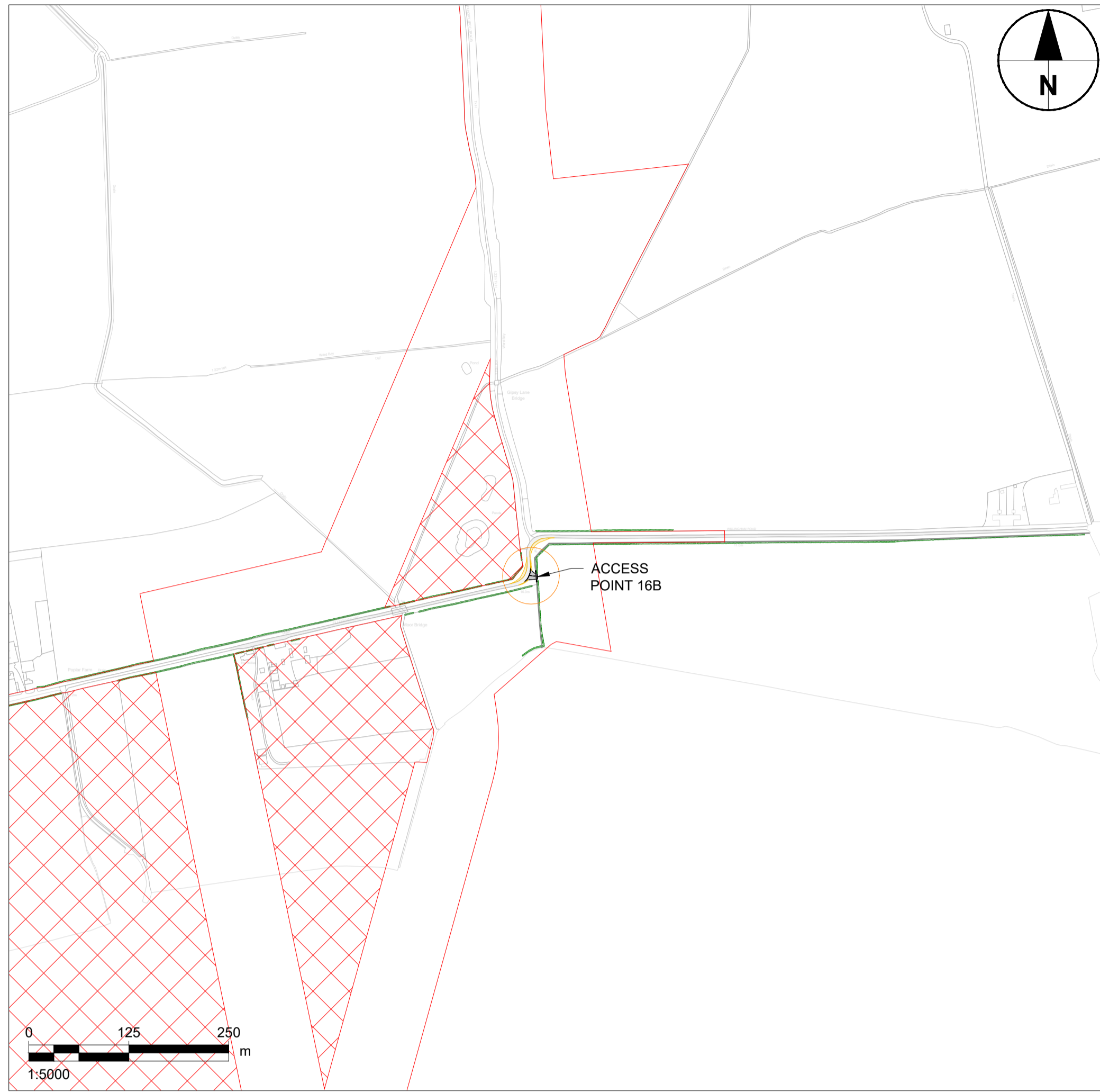

- Notes
1. ALL DIMENSIONS IN METRES UNLESS STATED OTHERWISE.
 2. DO NOT SCALE FROM THIS DRAWING USE ONLY FIGURED DIMENSIONS.
 3. VISIBILITY X DISTANCE IS BASED ON 2.4m WHICH IS A PERMITTED RELAXATION IN ACCORDANCE WITH CD123 DOCUMENTATION SUBJECT TO APPROVAL BY LINCOLNSHIRE COUNTY COUNCIL.

- KEY:
- EXISTING TREES
 - EXISTING HEDGEROW / VEGETATION
 - VISIBILITY SPLAY
 - PROPOSED BELLMOUTH
 - EXISTING CARRIAGEWAY
 - PROPOSED ROAD WIDENING REFER TO DRAWING 60682158-ACM-XX-00-DR-CE-1402 FOR DETAILS.
 - DCO SUBMISSION ORDER LIMITS

ISSUE/REVISION

Rev	Date	Description	Drn/Chk/Appr
B	15.03.24	FINALISED FOR DCO SUBMISSION	EP/GM&E/CGY
A	27.02.24	MINOR AMENDMENTS	GM&E/EP/CGY
-	05.10.23	FIRST ISSUE	GM&E/EP

NOT FOR CONSTRUCTION
FOR INFORMATION ONLY

Purpose Of Issue
 DCO SUBMISSION

Project Number
 60682158

Sheet Title
 PROPOSED ACCESS POINT 16B (FILLINGHAM LANE)

Sheet Number
 60682158-ACM-XX-00-DR-CE-1049

Scale: VARIES @ A1
 Rev: B

This drawing has been prepared for the use of AECOM's client. It may not be used, modified, reproduced or relied upon by third parties, except as agreed by AECOM or as required by law. AECOM accepts no responsibility, and denies any liability, whatsoever, to any party that uses or relies on this drawing without AECOM's express written consent. Do not scale this document. All measurements must be obtained from the stated dimensions.

KEY:

- DCO SUBMISSION ORDER LIMITS
- EXISTING TREES
- EXISTING HEDGEROW / VEGETATION
- VISIBILITY SPLAY
- NEW SURFACED BELLMOUTH
- EXISTING CARRIAGEWAY
- PROPOSED ROAD WIDENING REFER TO DRAWING 1402 FOR DETAILS.

ISSUE/REVISION

Rev	Date	Description	Drm/Chk/Appr
C	15.03.24	FINALISED FOR DCO SUBMISSION	GM/GM/EGDY
B	06.12.23	MINOR AMENDMENTS	GM/EJ/MCGDY
A	08.09.23	VISIBILITY X DISTANCE AMENDED	GM/GM/EGDY
-	23.08.23	FIRST ISSUE	MM/GM/EGDY

NOT FOR CONSTRUCTION
FOR INFORMATION ONLY

Purpose Of Issue

DCO SUBMISSION

Project Number

60682158

Sheet Title

PROPOSED ACCESS POINT 17
 (WILLINGHAM ROAD)

Sheet Number

60682158-ACM-XX-00-DR-CE-1043

Scale: AS SHOWN @ A1 **Rev:** C

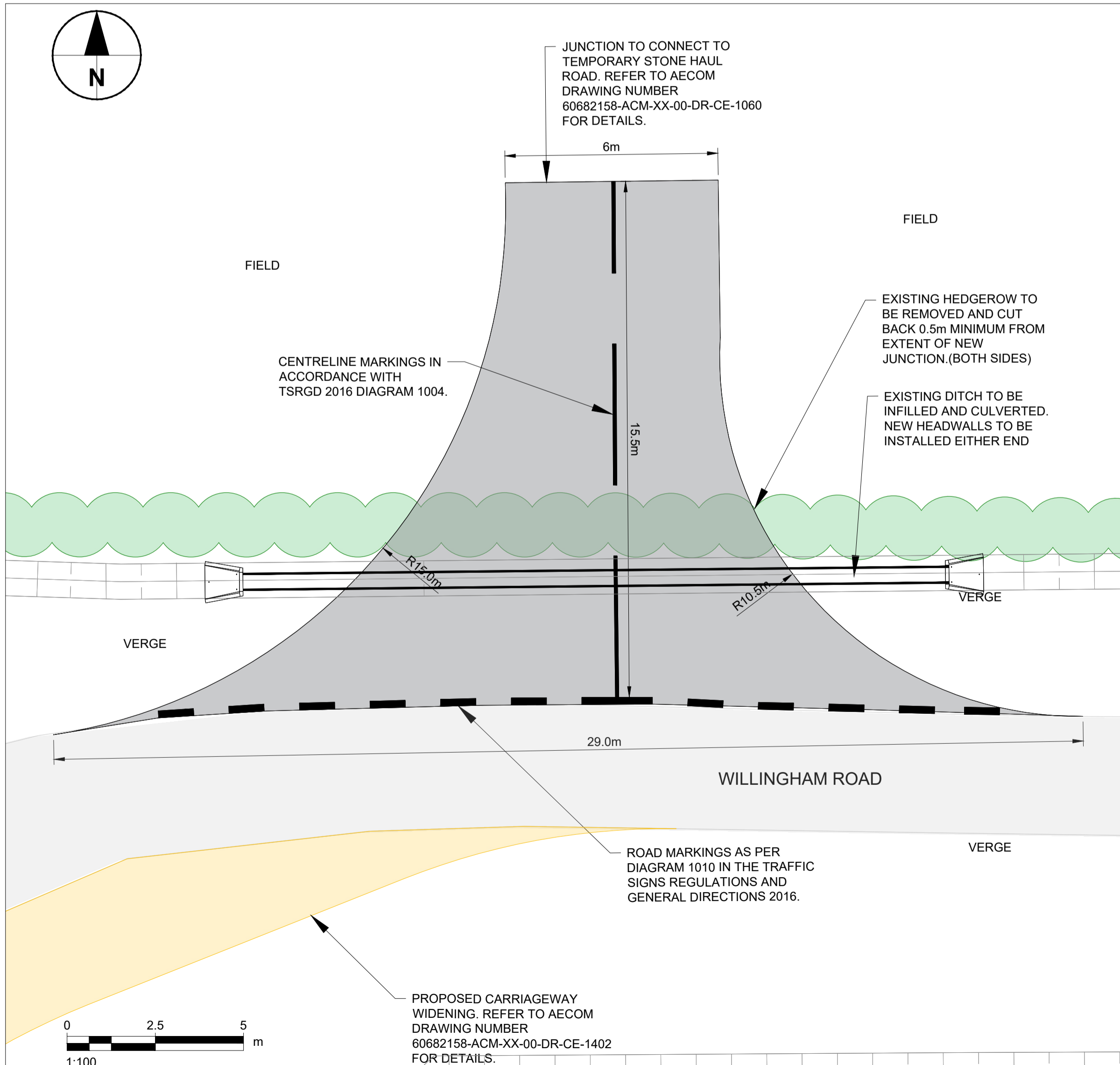
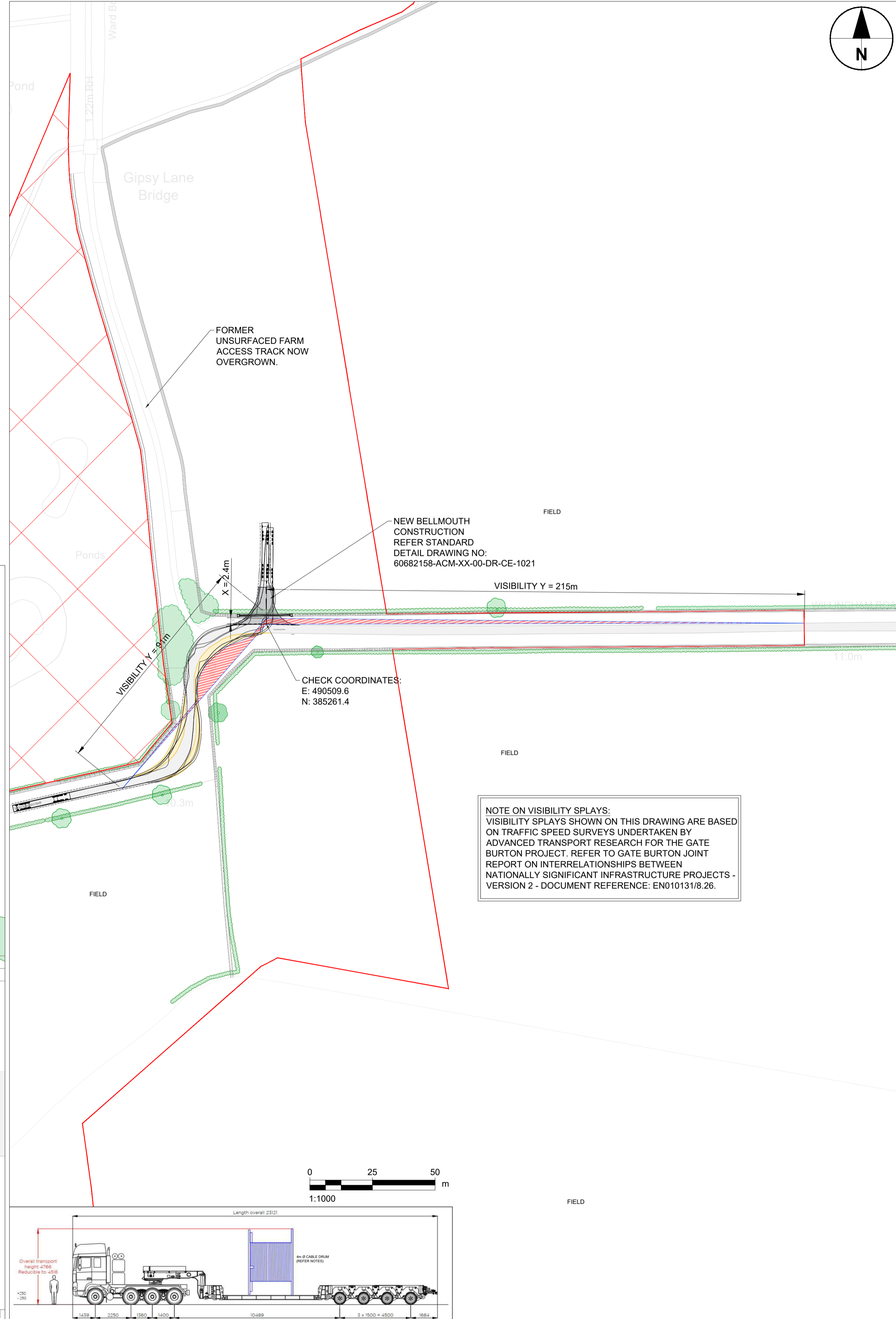
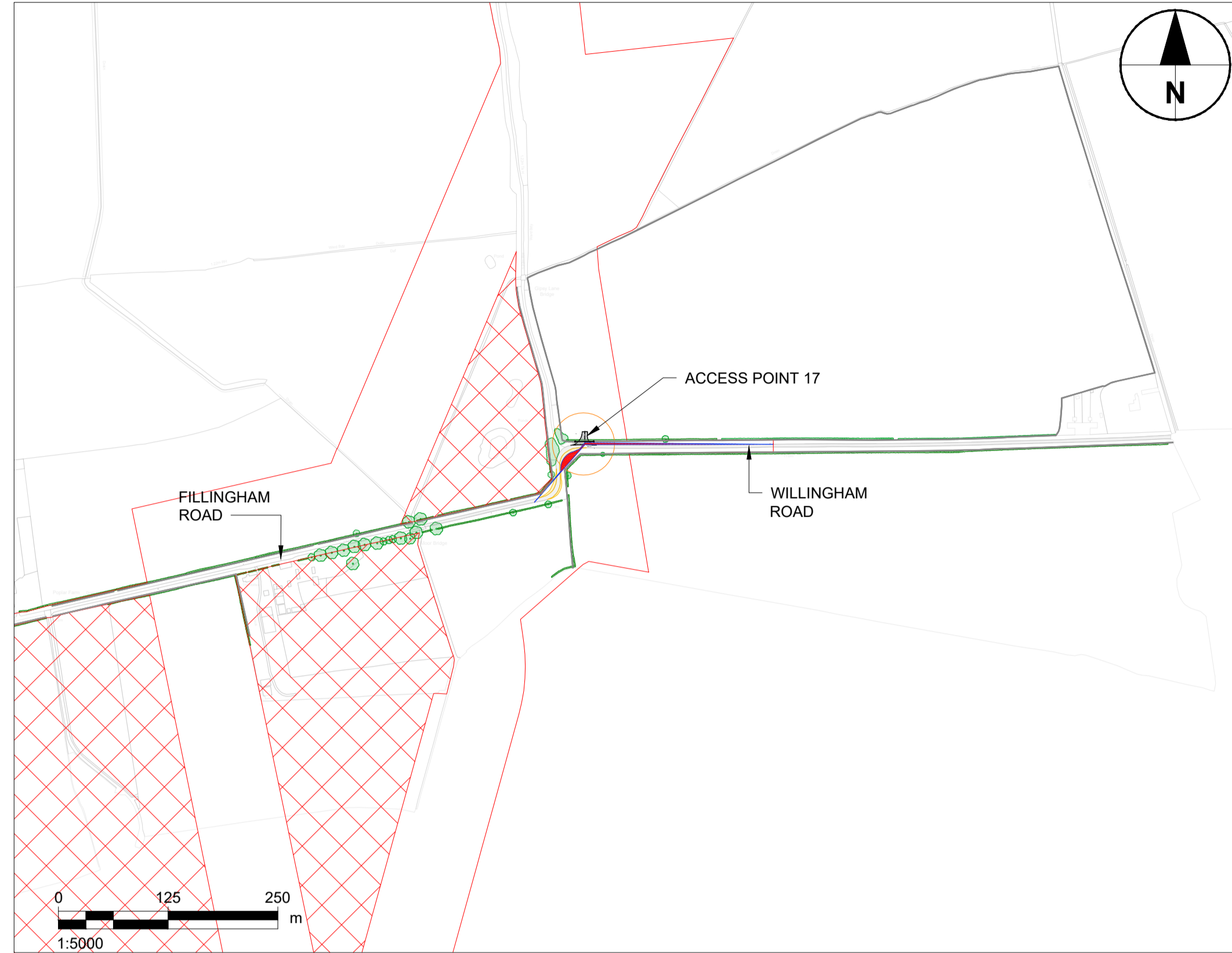

KEY:

- DCO SUBMISSION ORDER LIMITS
- EXISTING FIELD GATE
- EXISTING TREES
- EXISTING HEDGEROW / VEGETATION
- VISIBILITY SPLAY
- NEW BELLMOUTH TO BE SURFACED
- EXISTING CARRIAGEWAY

ISSUE/REVISION

Rev	Date	Description	Drm/Chk/Appr
D	15.03.24	FINALISED FOR DCO SUBMISSION	GM/GM/ECGY
C	06.12.23	MINOR AMENDMENTS	GM/EJ/MCGY
B	03.10.23	JUNCTION AMENDED TO PROTECT LWS	GM/GM/REP
A	08.09.23	VISIBILITY X DISTANCE AMENDED	GM/GM/REP
-	23.08.23	FIRST ISSUE	MM/GM/REP

NOT FOR CONSTRUCTION
FOR INFORMATION ONLY

Purpose Of Issue

DCO SUBMISSION

Project Number

60682158

Sheet Title

PROPOSED ACCESS POINT 18
 (COW LANE)

Sheet Number

60682158-ACM-XX-00-DR-CE-1044

Scale: AS SHOWN @ A1 Rev: D

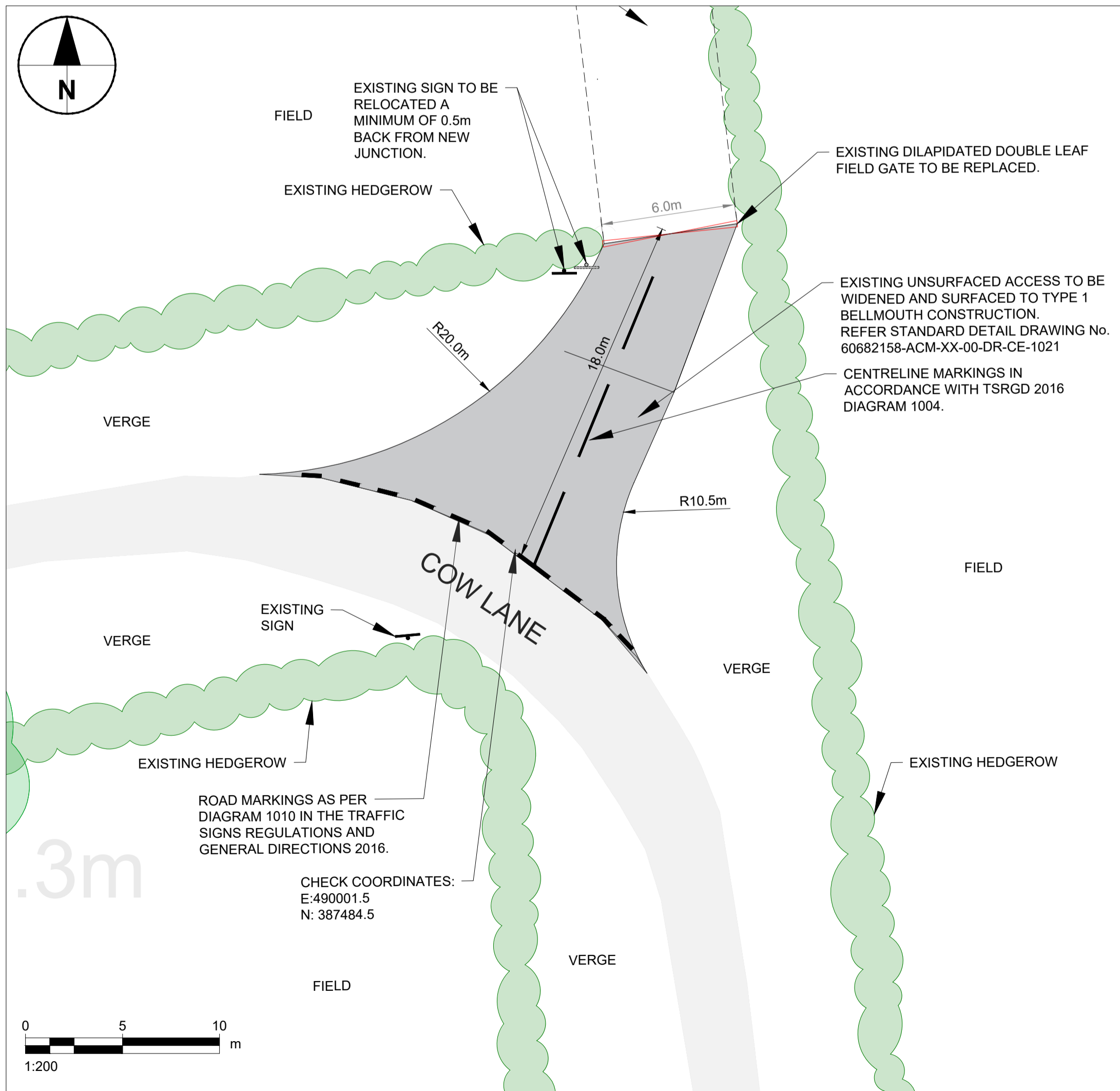
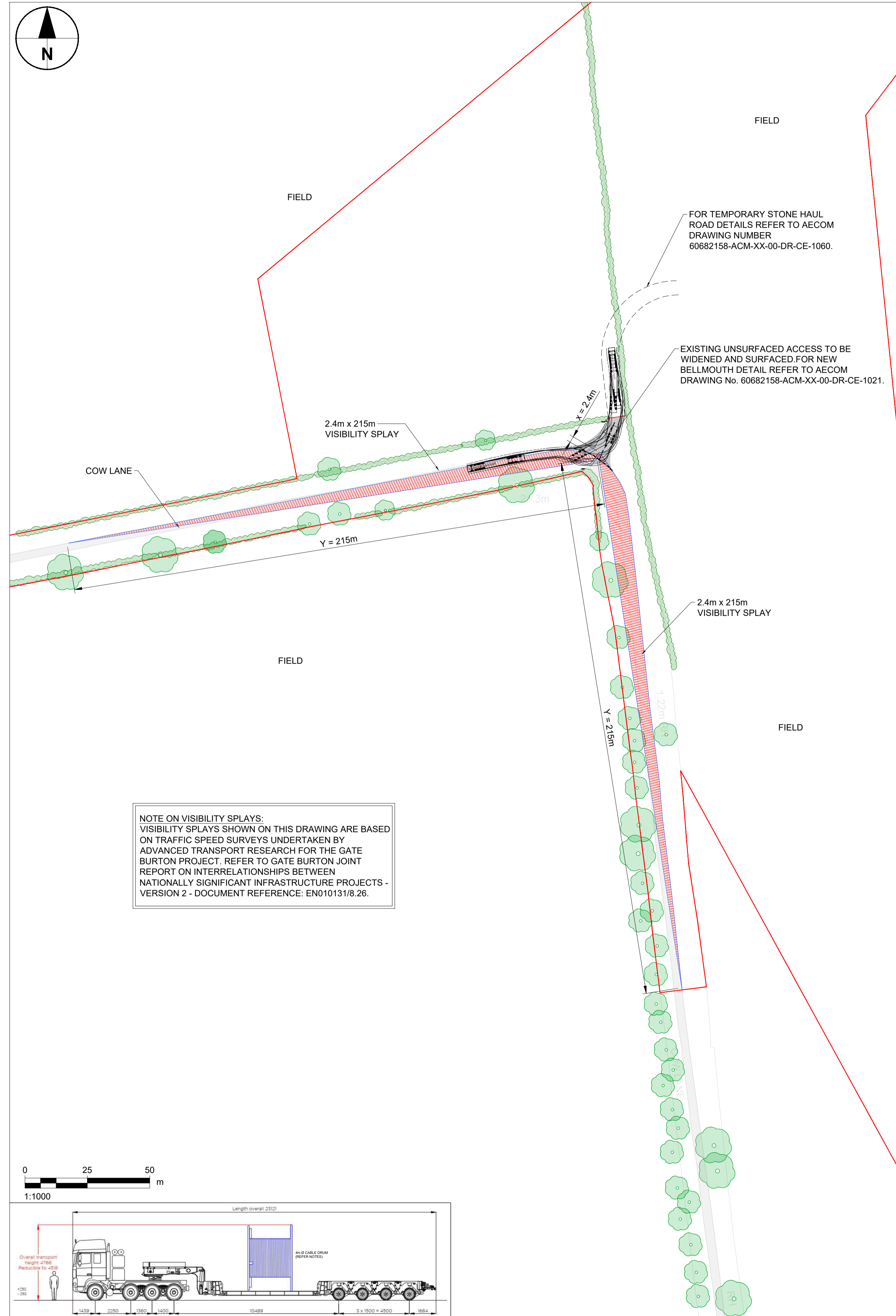
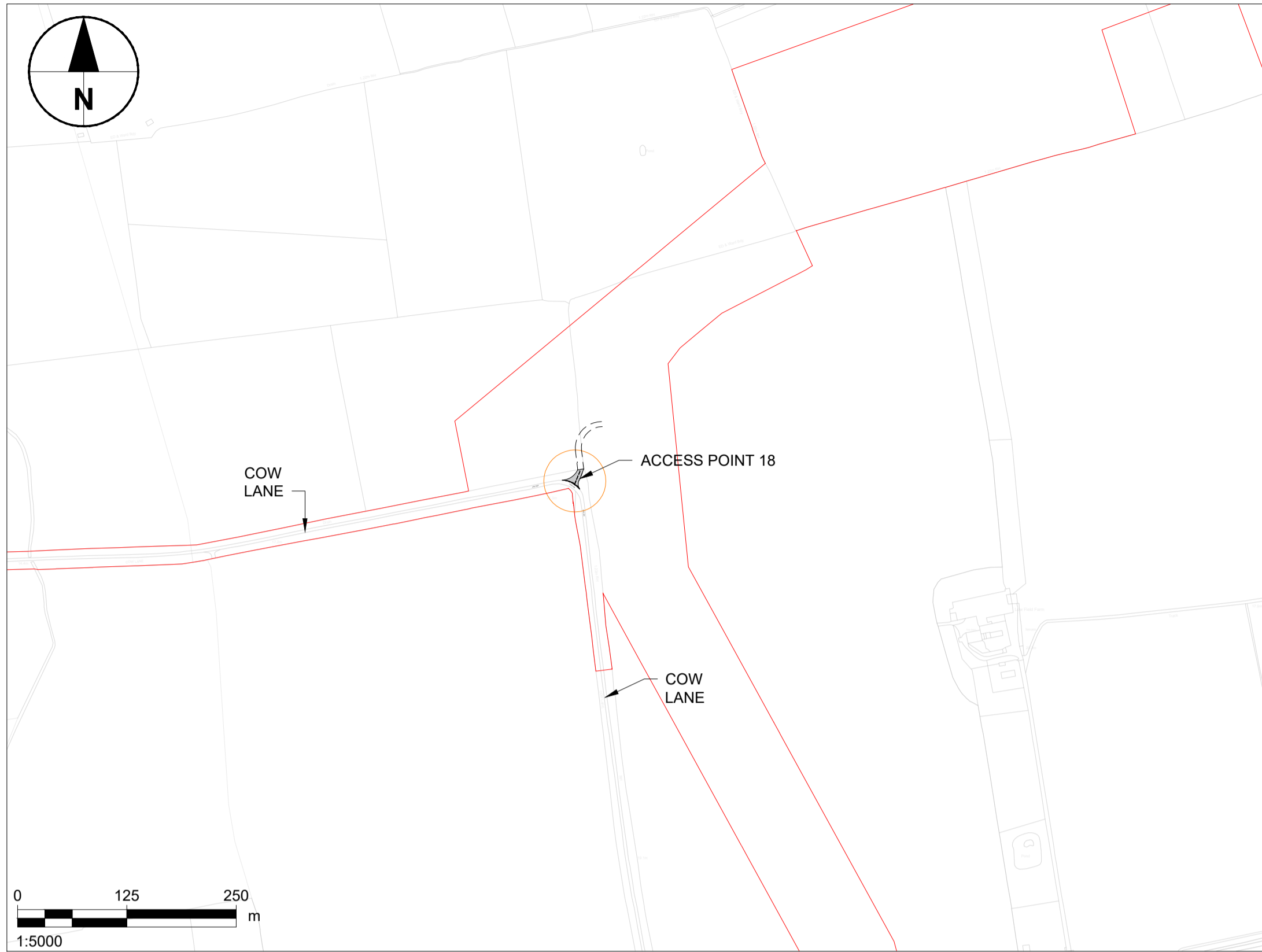

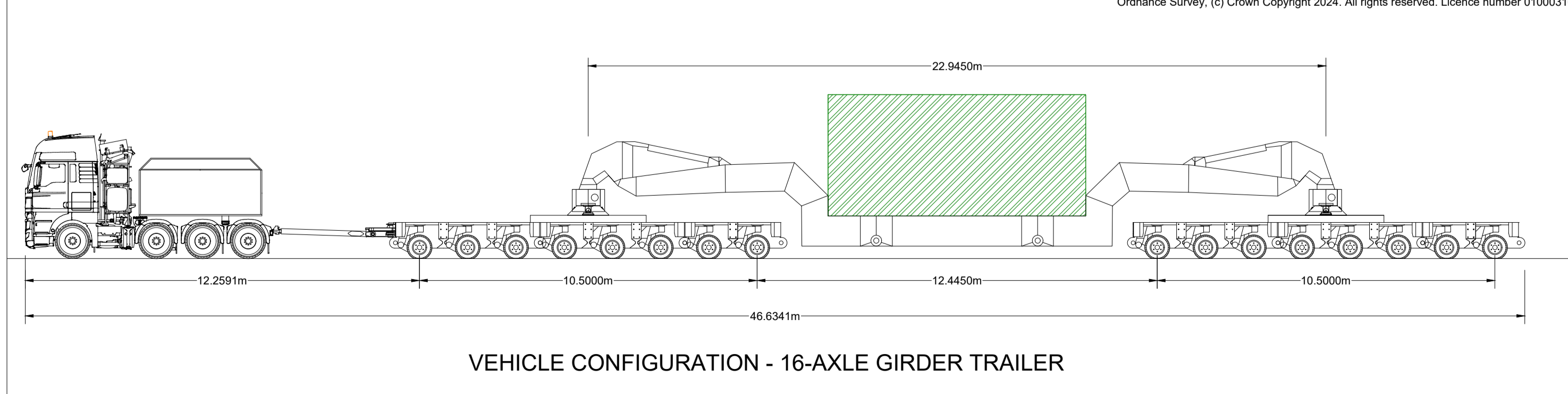
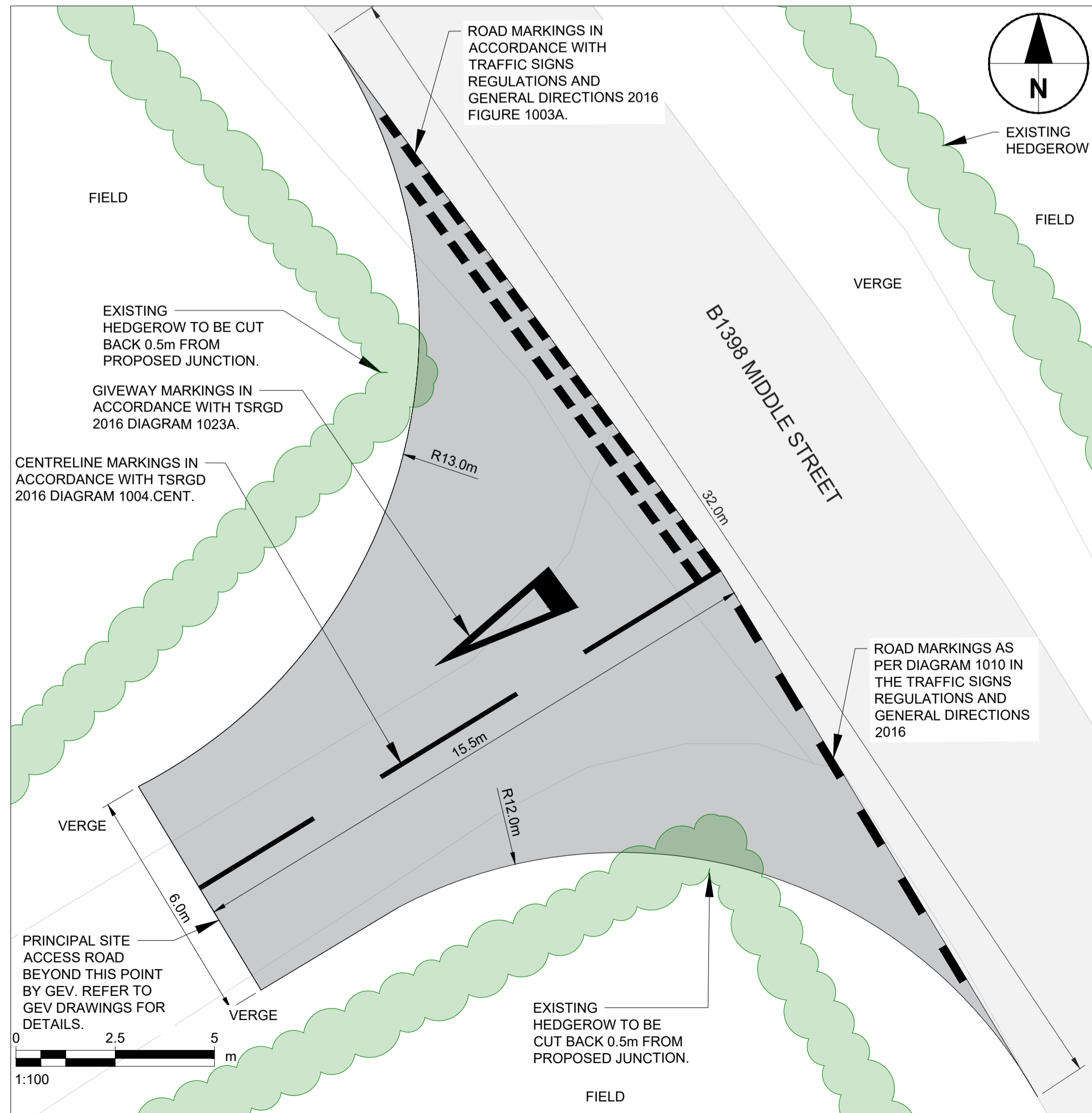
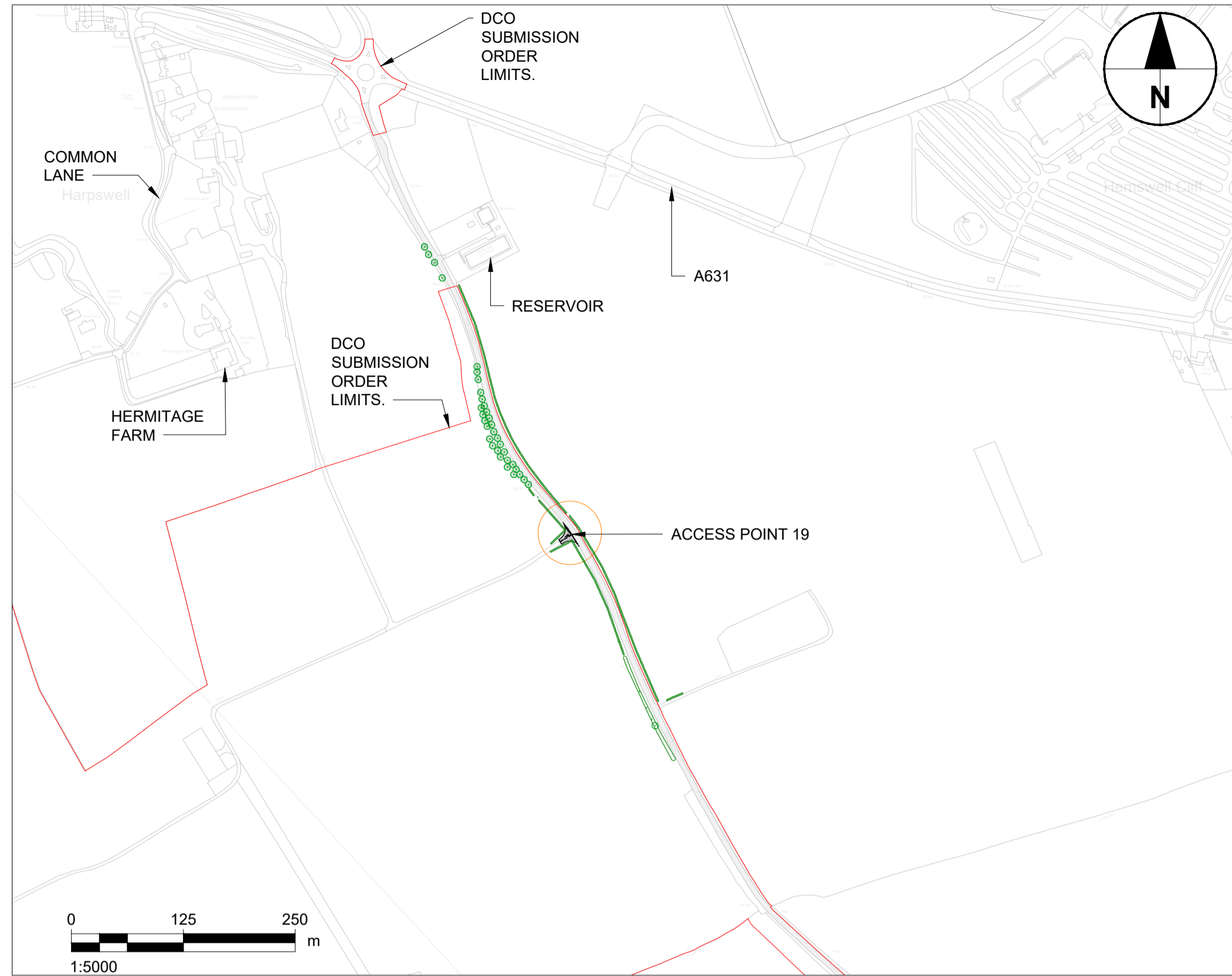

KEY:

- DCO SUBMISSION ORDER LIMITS
- EXISTING TREES / HEDGES / VEGETATION
- HEDGEROW / VEGETATION
- VISIBILITY SPLAY
- PROPOSED NEW BELLMOUTH ACCESS POINTS
- APPROX VEHICLE WHEEL TRACK
- APPROX VEHICLE OVER SAIL
- EXISTING CARRIAGEWAY

ISSUE/REVISION

Rev	Date	Description	Drm/Chk/Appr
D	22.03.24	PRINCIPAL SITE DCO ORDER LIMITS CORRECTED	GM/EP/CGY
C	15.03.24	FINALISED FOR DCO SUBMISSION	GM/GE/CGY
B	06.12.23	MINOR AMENDMENTS	GM/EM/CGY
A	13.09.23	UPDATED TO SUIT SUBSTATION AL DELIVERIES	GM/EP/CGY
-	23.08.23	FIRST ISSUE	MM/GM/EP

NOT FOR CONSTRUCTION
FOR INFORMATION ONLY

This drawing has been prepared for the use of AECOM's client. It may not be used, modified, reproduced or relied upon by third parties, except as agreed by AECOM, or as required by law. AECOM accepts no responsibility, and denies any liability, whatsoever, to any party that uses or relies on this drawing without AECOM's express written consent. Do not scale this document. All measurements must be obtained from the stated dimensions.

LEGEND

- DCO SUBMISSION ORDER LIMITS
- EXISTING FENCE
- EXISTING TREE
- EXISTING HEDGE
- EXISTING ROAD
- PROPOSED BELLMOUTH ACCESS POINT
- VISIBILITY SPLAY

ISSUE/REVISION

Rev	Date	Description	Dm/Chk/Appr
D	22.03.24	DCO SUBMISSION ORDER LIMITS CORRECTED.	GM&E/EP/CGY
C	15.03.24	FINALISED FOR DCO SUBMISSION	EP/GM&E/CGY
B	06.12.23	FINALISED FOR DISCUSSION WITH LHA.	GM&E/JM/CGY
A	08.09.23	VISIBILITY X DISTANCE AMENDED	GM&E/EP
-	23.08.23	FIRST ISSUE	MM&F/JM/GM

NOT FOR CONSTRUCTION
FOR INFORMATION ONLY

Purpose Of Issue

DCO SUBMISSION

Project Number

60682158

Sheet Title

PROPOSED ACCESS POINT 20 /
 PRINCIPAL SITE ACCESS 2
 (HARPSWELL LANE)

Sheet Number

60682158-ACM-XX-00-DR-CE-1046

Scale: AS SHOWN @ A1 Rev: D

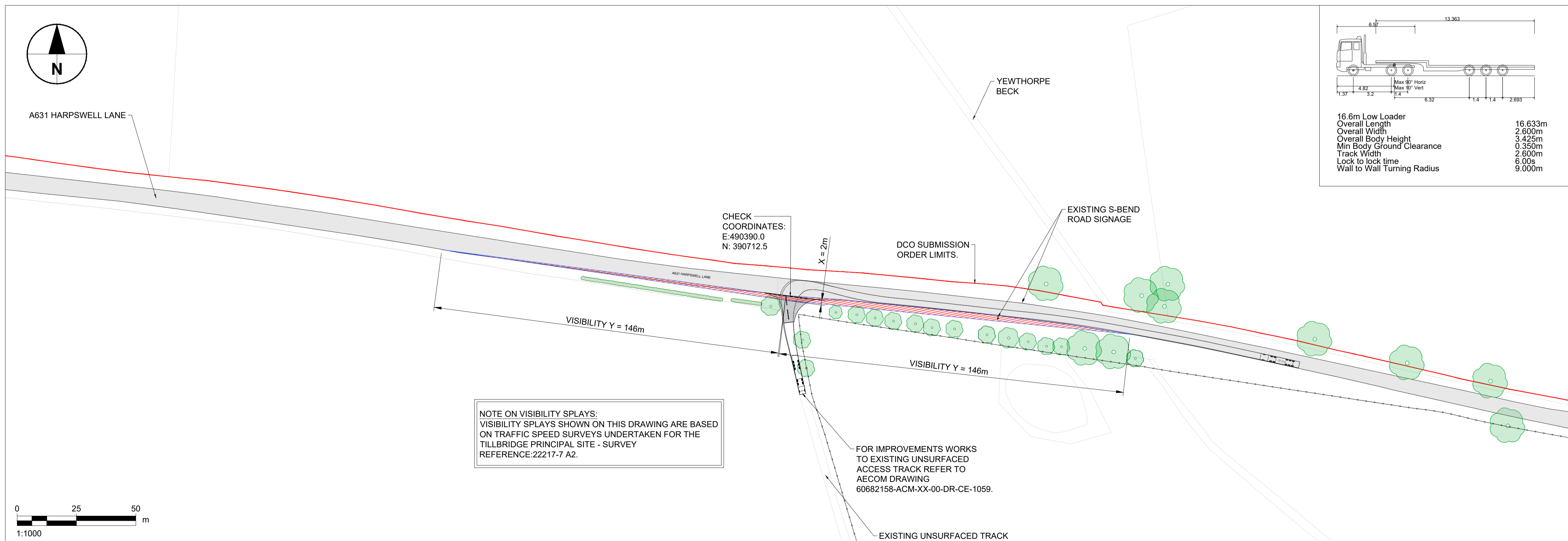
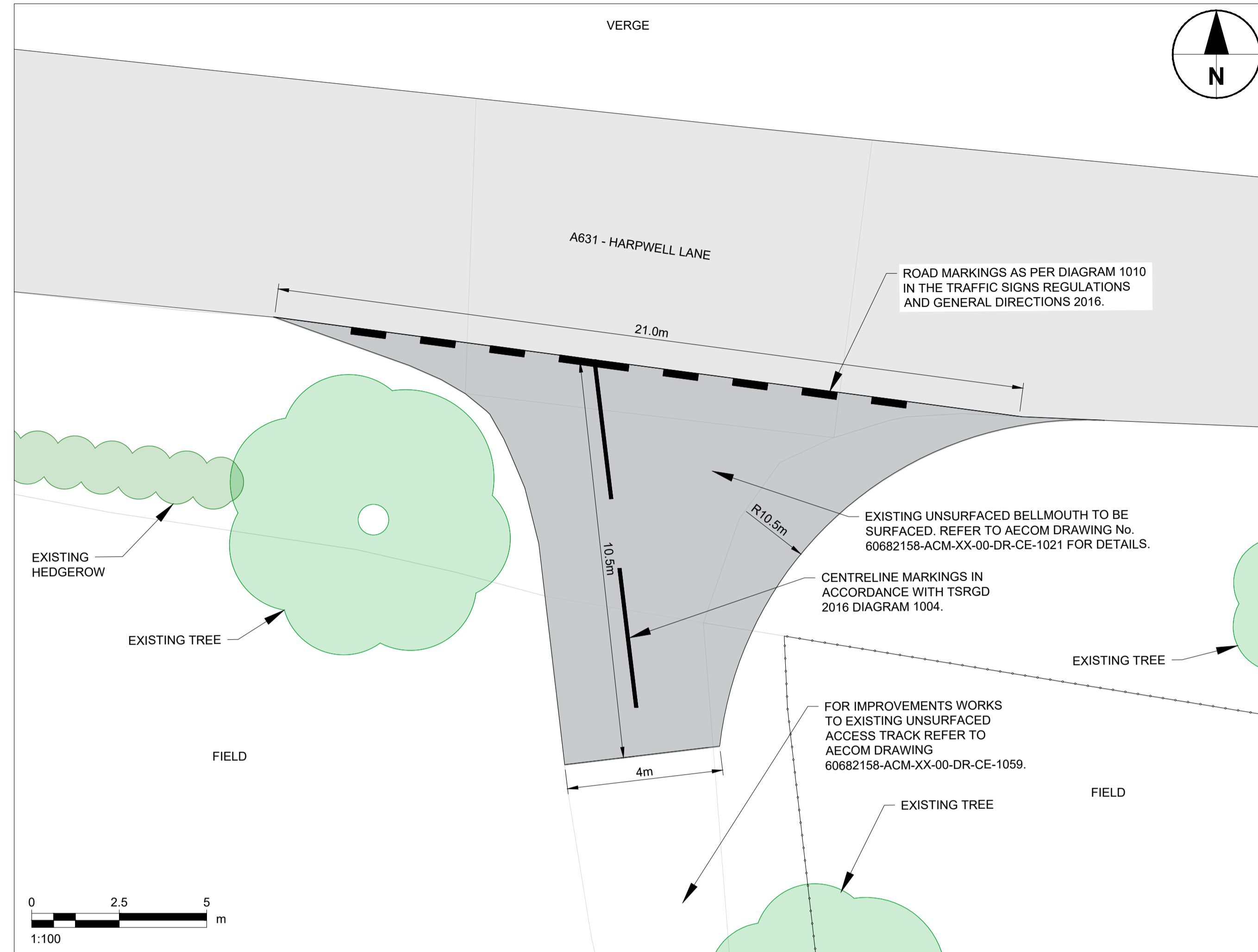
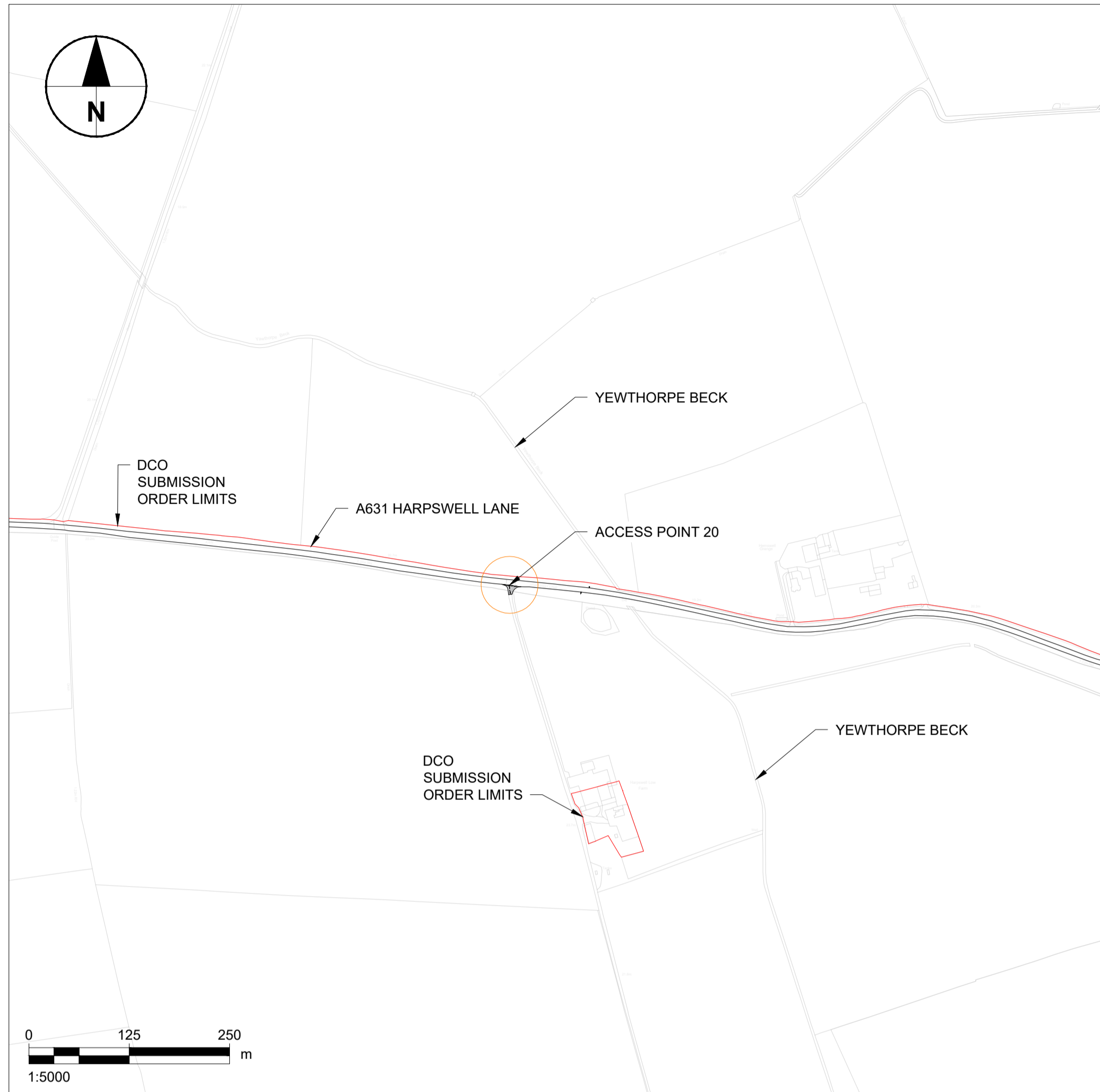

- Notes**
- ALL DIMENSIONS IN METRES UNLESS STATED OTHERWISE.
 - DO NOT SCALE FROM THIS DRAWING USE ONLY FIGURED DIMENSIONS.
 - VISIBILITY X DISTANCE IS BASED ON 2m WHICH IS A PERMITTED DIRECT ACCESS X DISTANCE IN ACCORDANCE WITH CD123 SECTION 3.8.
 - VEHICLE TRACKING SHOWN IS INDICATIVE ONLY. TRACKING T.B.C BY HEAVY HAULAGE PROVIDER AT DETAILED DESIGN STAGE.

- KEY:**
- DCO SUBMISSION ORDER LIMITS
 - EXISTING TREE
 - EXISTING HEDGE
 - EXISTING ROAD
 - PROPOSED BELLMOUTH ACCESS POINT
 - TEMPORARY STONE WIDENING FOR AIL VEHICLES
 - EXISTING ROAD SIGN
 - APPROX VEHICLE WHEEL TRACK
 - APPROX VEHICLE OVER-SAIL

ISSUE/REVISION

Rev	Date	Description	Dwn/Chk/Appr
E	22.03.24	DCO SUBMISSION ORDER LIMITS CORRECTED.	GM&E/EP/CGY
D	15.03.24	FINALISED FOR DCO SUBMISSION.	EP/GM&E/CGY
C	06.12.23	FINALISED FOR DISCUSSION WITH LHA.	GM&E/JM/CGY
B	06.10.23	AMENDED TO SHOW VEHICLE TRACKING INFORMATION.	DWT/GM&E/CGY
A	13.09.23	UPDATED TO SUIT SUBSTATION AIL DELIVERIES.	GM/GM&E/EP
-	23.08.23	FIRST ISSUE	MM/GM&E/EP

NOT FOR CONSTRUCTION
FOR INFORMATION ONLY

Purpose Of Issue
DCO SUBMISSION

Project Number
60682158

Sheet Title
PROPOSED ACCESS POINT 21 /
PRINCIPAL SITE ACCESS 1
(HARPSWELL LANE/ SCHOOL
LANE)

Sheet Number
60682158-ACM-XX-00-DR-CE-1047

Scale: AS SHOWN @ A1 **Rev:** E

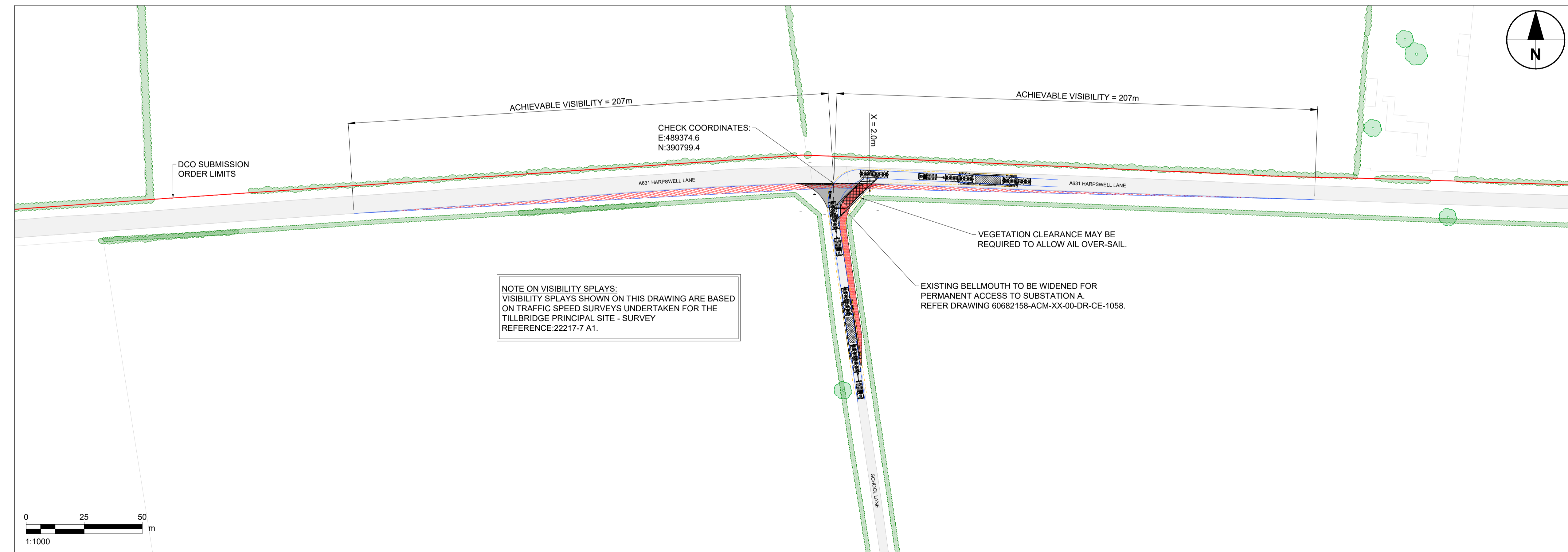
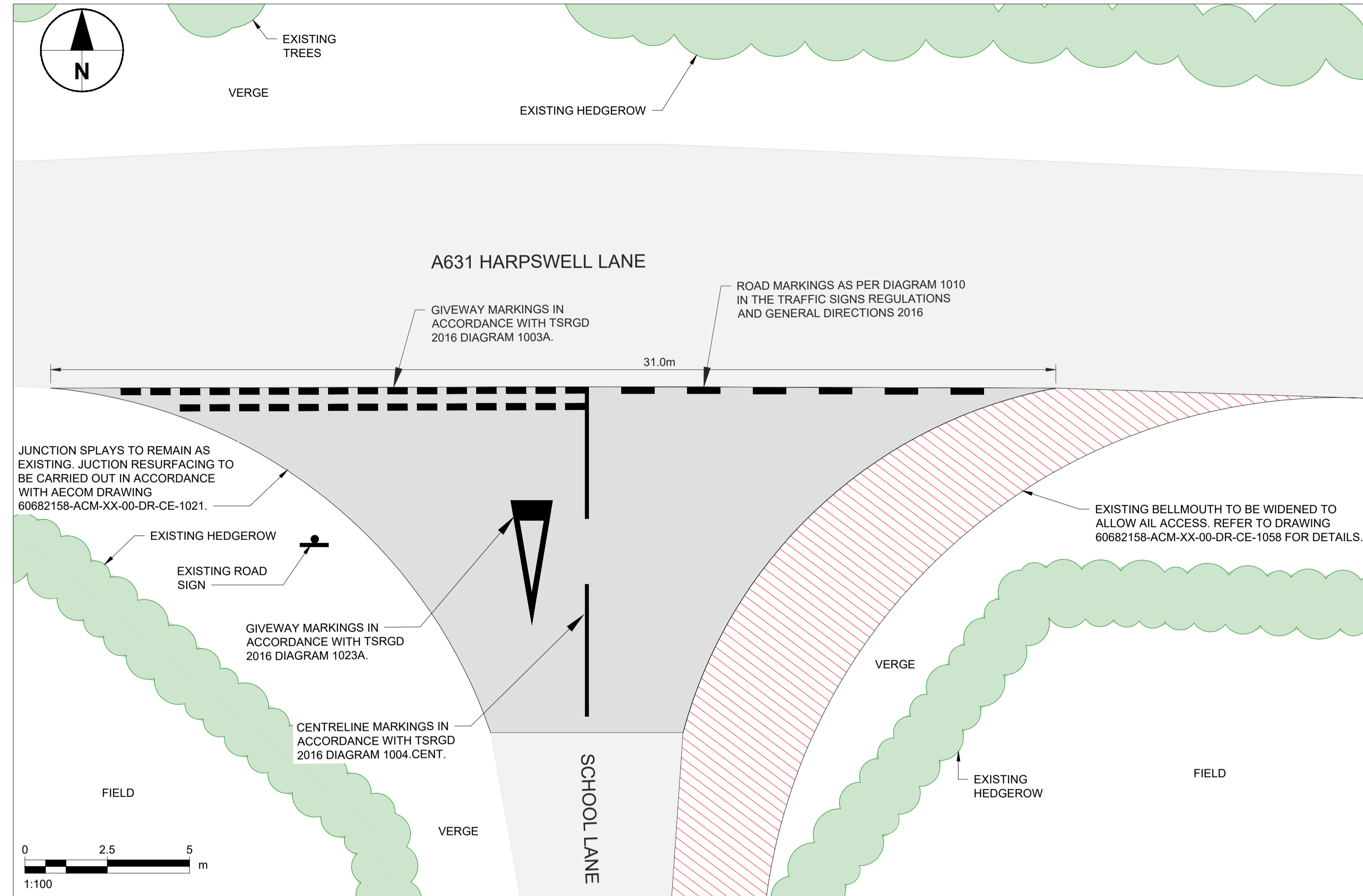
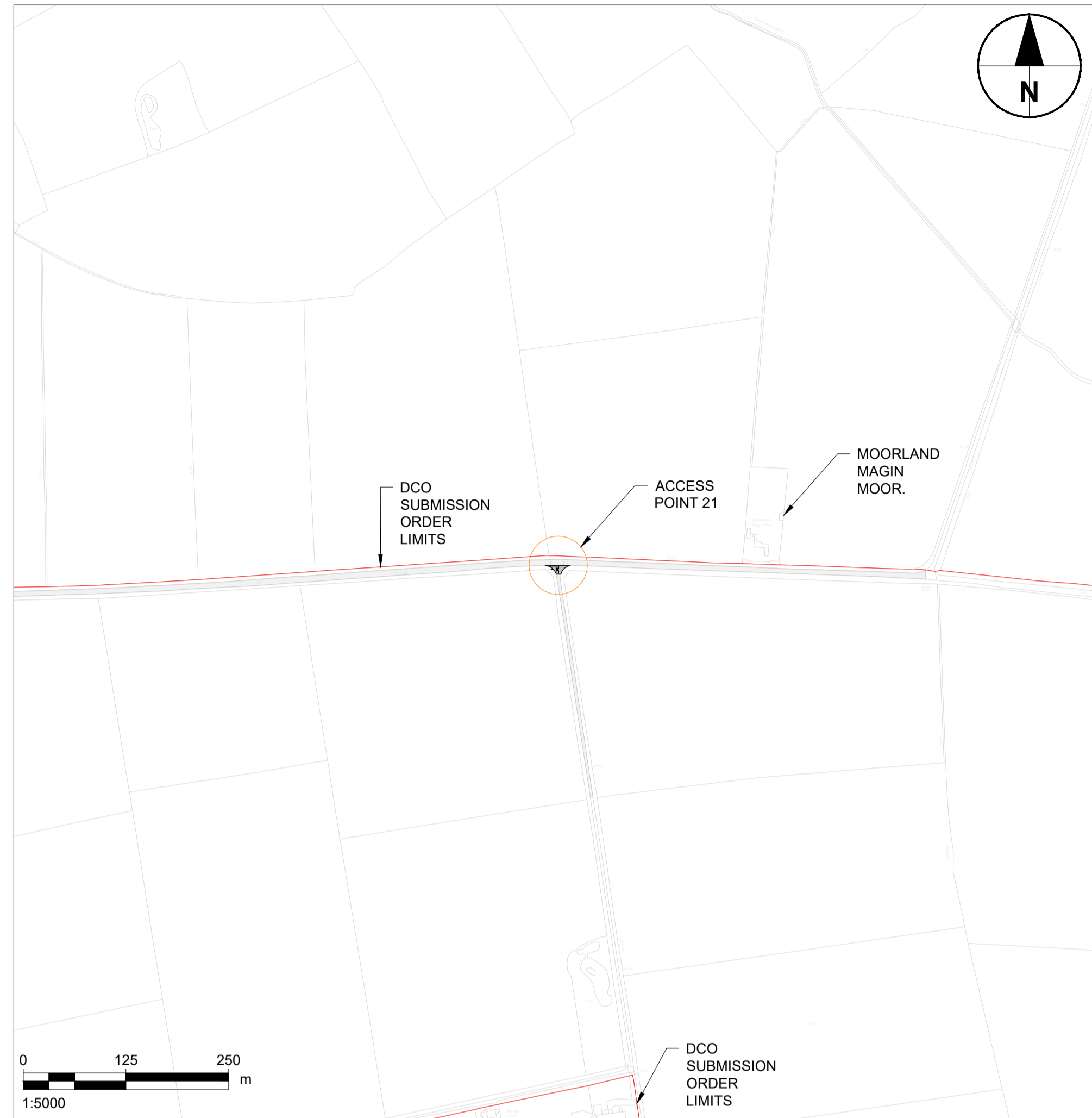

ISSUE/REVISION

Rev	Date	Description	Dwn/Chk/Appr
A	22.03.24	DCO SUBMISSION ORDER LIMITS ADDED	GM/EP/CGY
-	15.03.24	FIRST ISSUE	GM/AM/EP

NOT FOR CONSTRUCTION
FOR INFORMATION ONLY

Purpose Of Issue

DCO SUBMISSION

Project Number

60682158

Sheet Title

PRINCIPAL SITE ACCESS 3
 (UNNAMED FARM ACCESS
 TRACK OFF HARPSWELL LANE)

Sheet Number

60682158-ACM-XX-00-DR-CE-1417

Scale: AS SHOWN @ A1 **Rev:** A

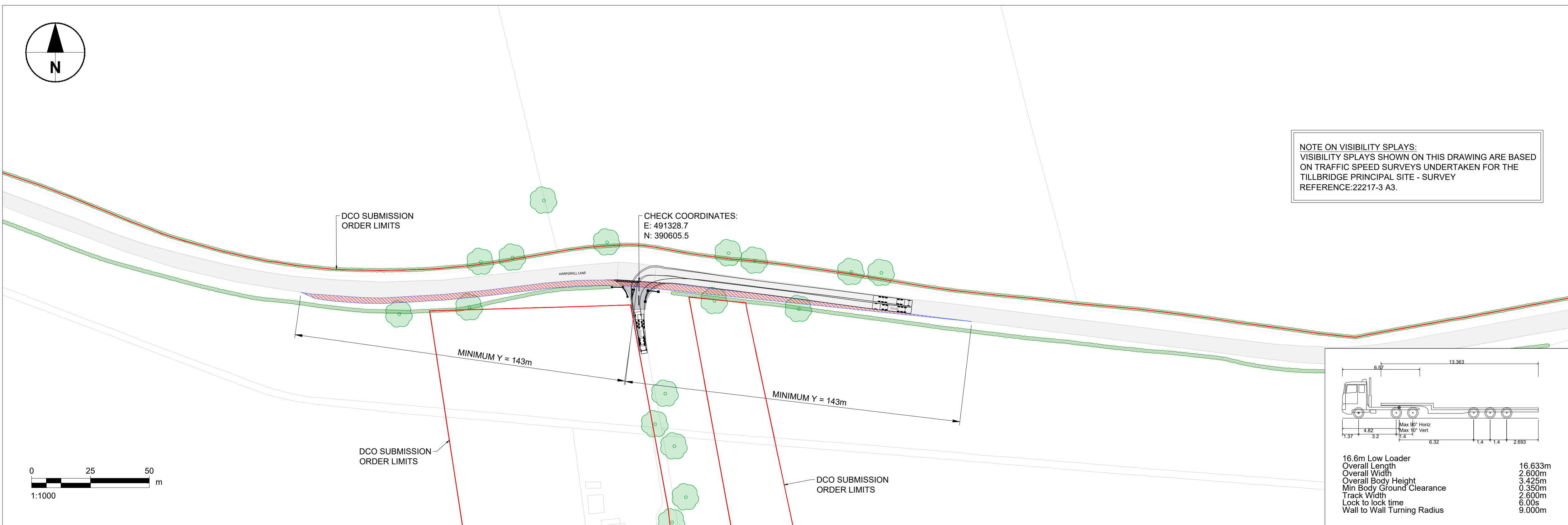
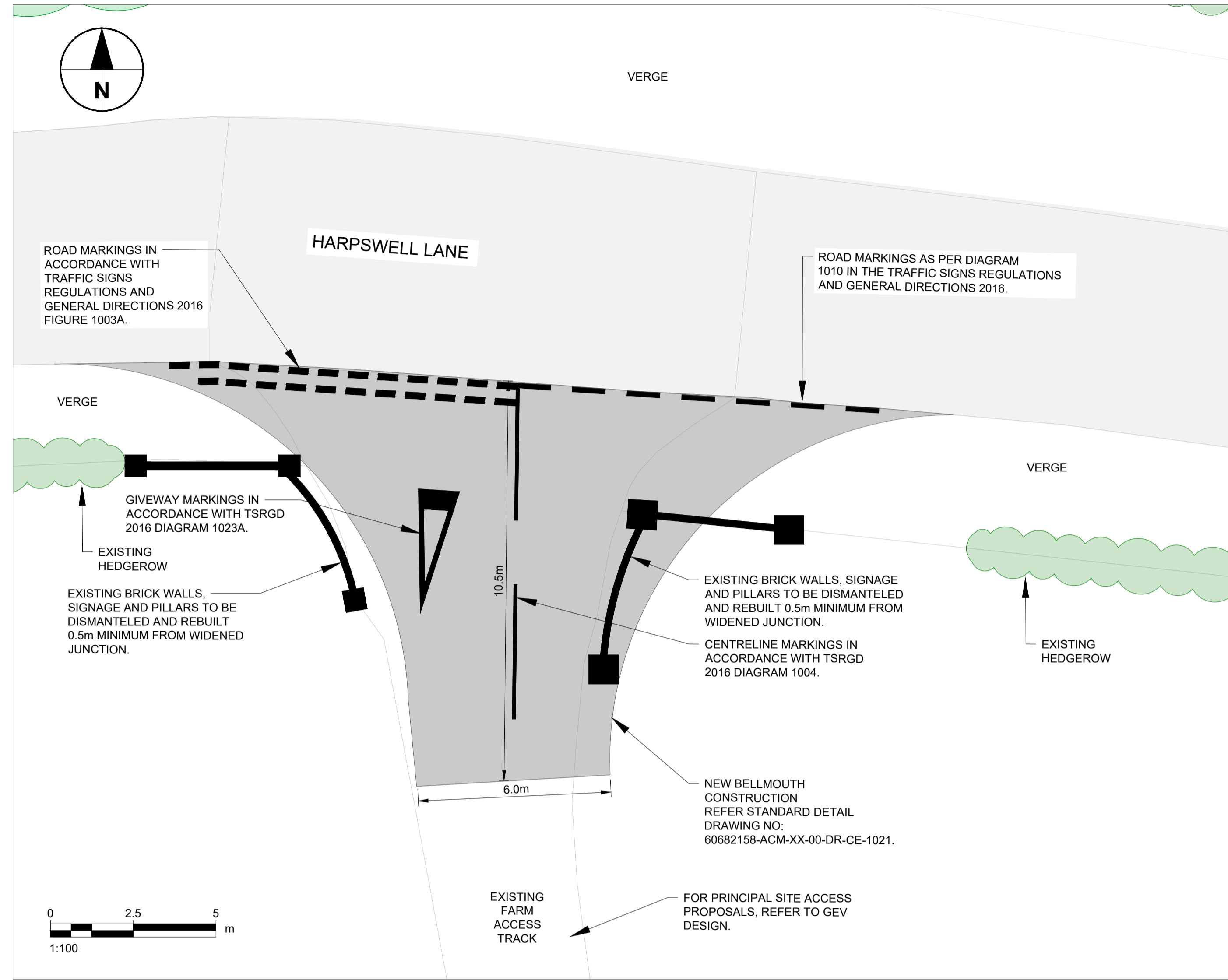
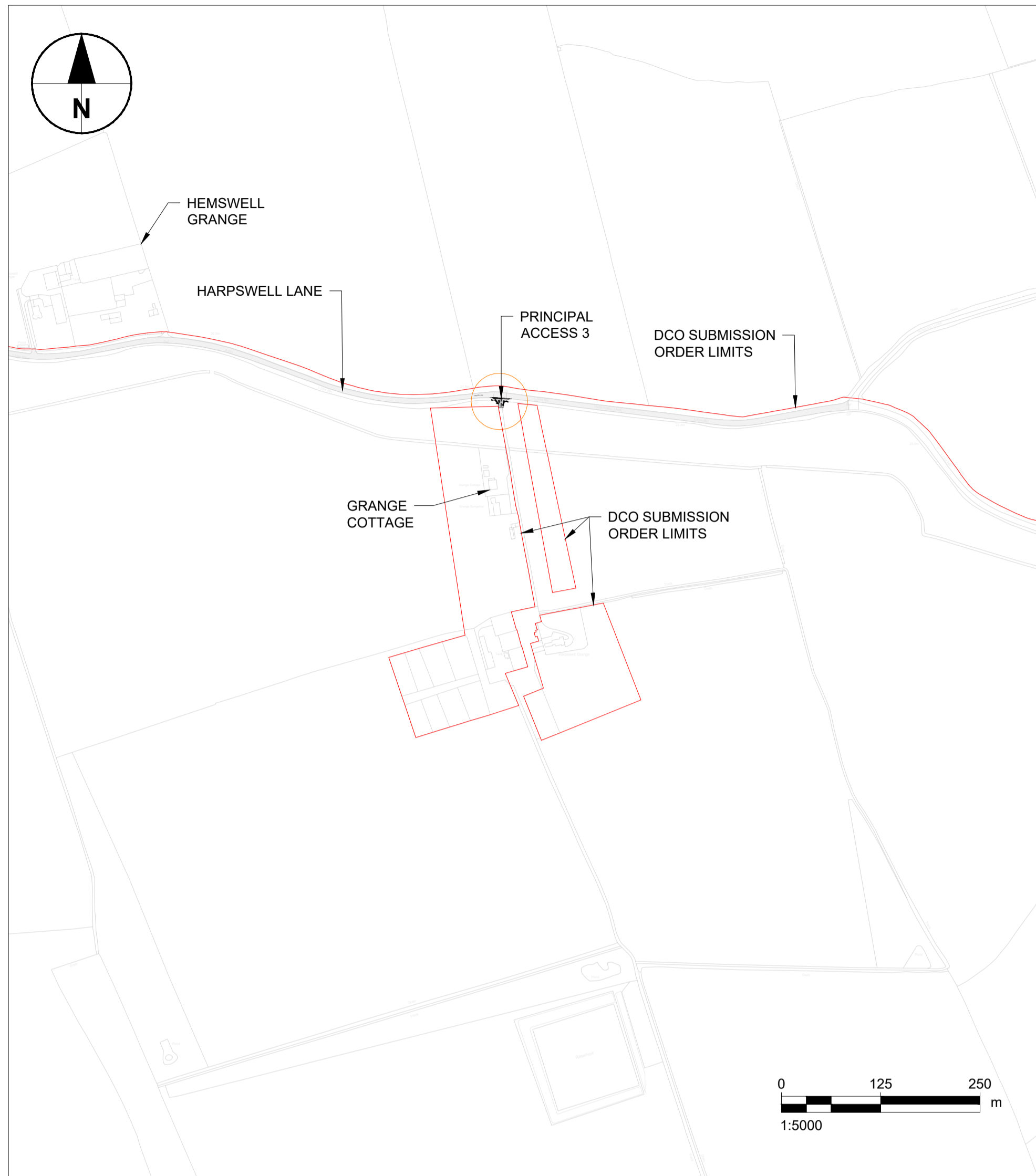

This drawing has been prepared for the use of AECOM's client. It may not be used, modified, reproduced or relied upon by third parties, except as agreed by AECOM or as required by law. AECOM accepts no responsibility, and denies any liability whatsoever, to any party that uses or relies on this drawing without AECOM's express written consent. Do not scale this document. All measurements must be obtained from the stated dimensions.

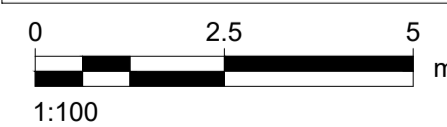
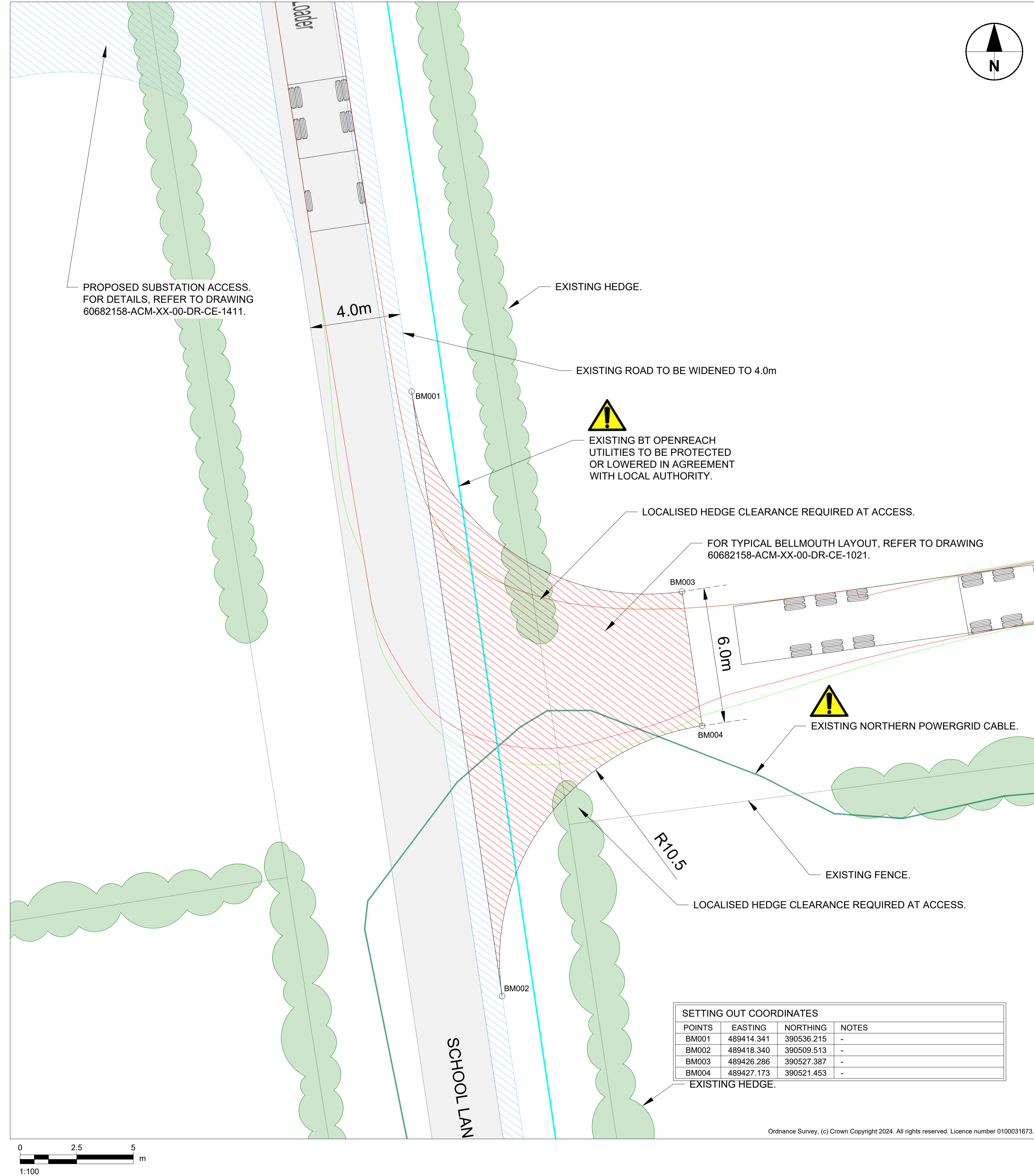
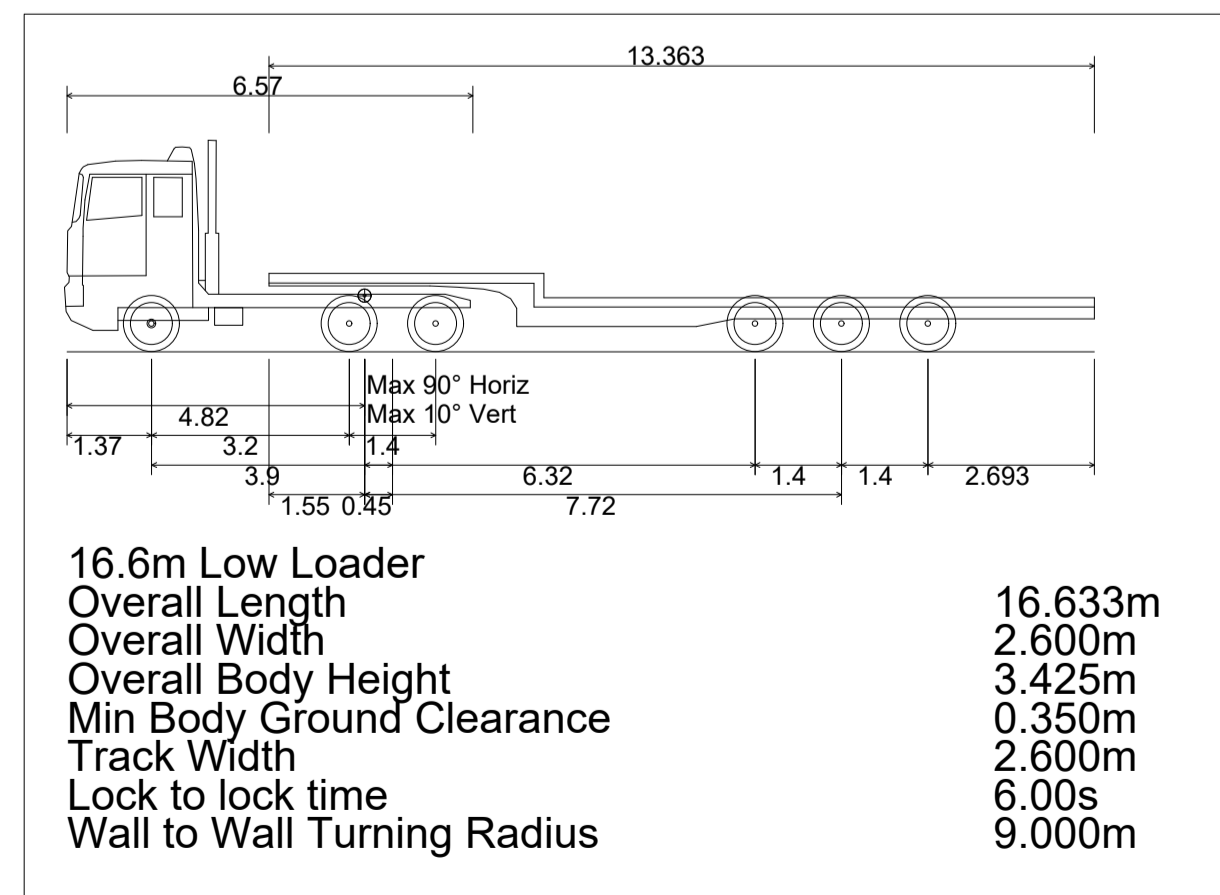
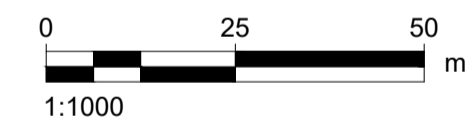
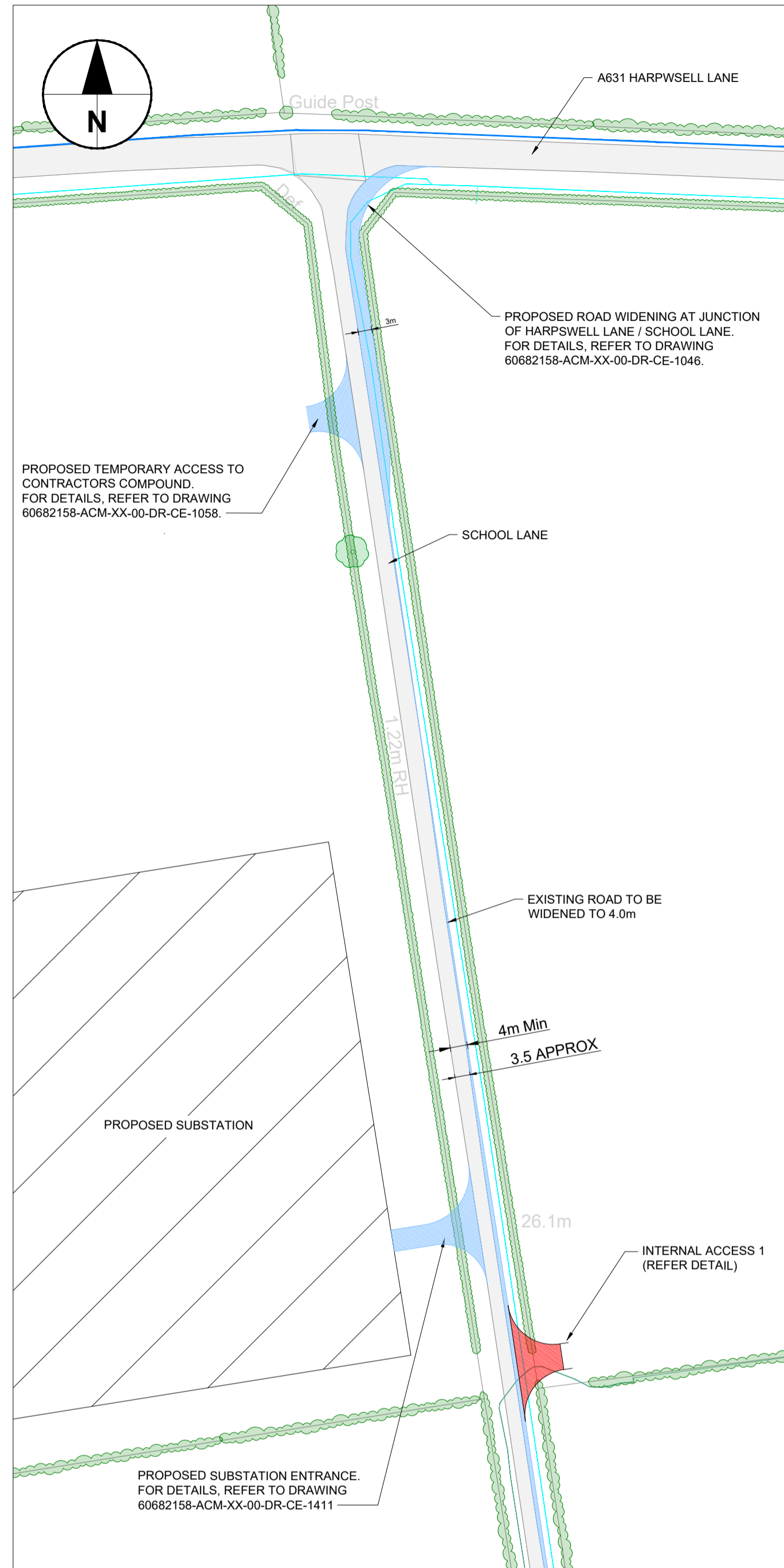

LEGEND

- EXISTING HEDGE
- EXISTING ROAD
- PROPOSED SUBSTATION
- PROPOSED ROAD WIDENING
- PROPOSED ACCESS BELLMOUTH
- BT OPENREACH
- NORTHERN POWER
- VEHICLE WHEEL TRACK
- VEHICLE BODY OVERHANG

ISSUE/REVISION

Rev	Date	Description	EP/ME/CGY	Drm/Chk/Appr
-	26.01.24	FIRST ISSUE		

NOT FOR CONSTRUCTION
FOR INFORMATION ONLY

This drawing has been prepared for the use of AECOM's client. It may not be used, modified, reproduced or relied upon by third parties, except as agreed by AECOM, and AECOM accepts no responsibility, and denies any liability, whatsoever, to any party that uses or relies on this drawing without AECOM's express written consent. Do not scale this document. All measurements must be obtained from the stated dimensions.

Ordnance Survey, (c) Crown Copyright 2024. All rights reserved. Licence number 0100031673.

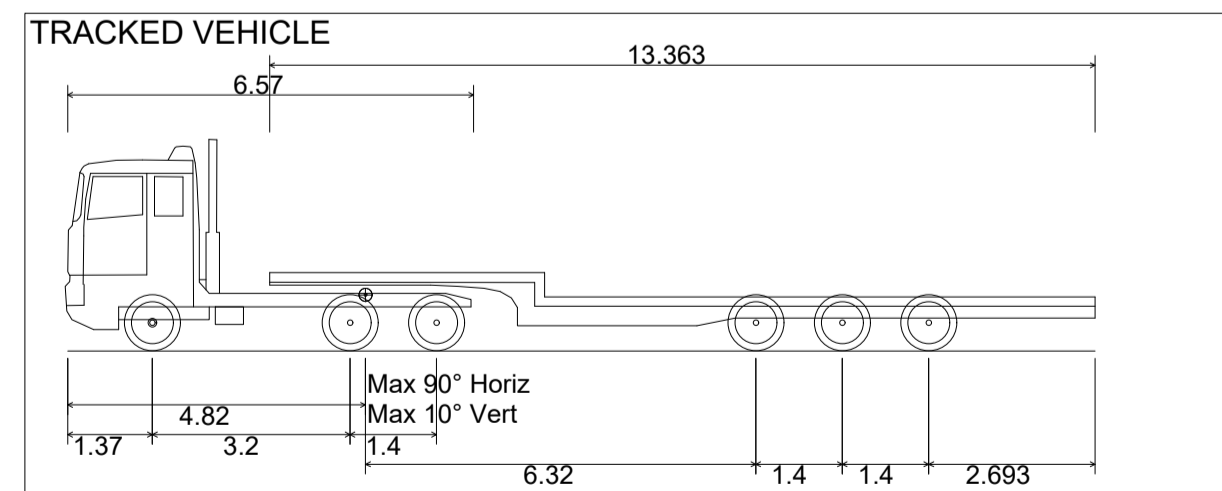
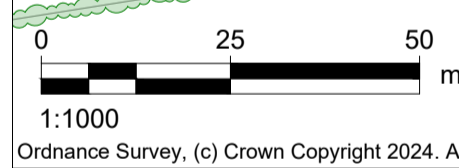
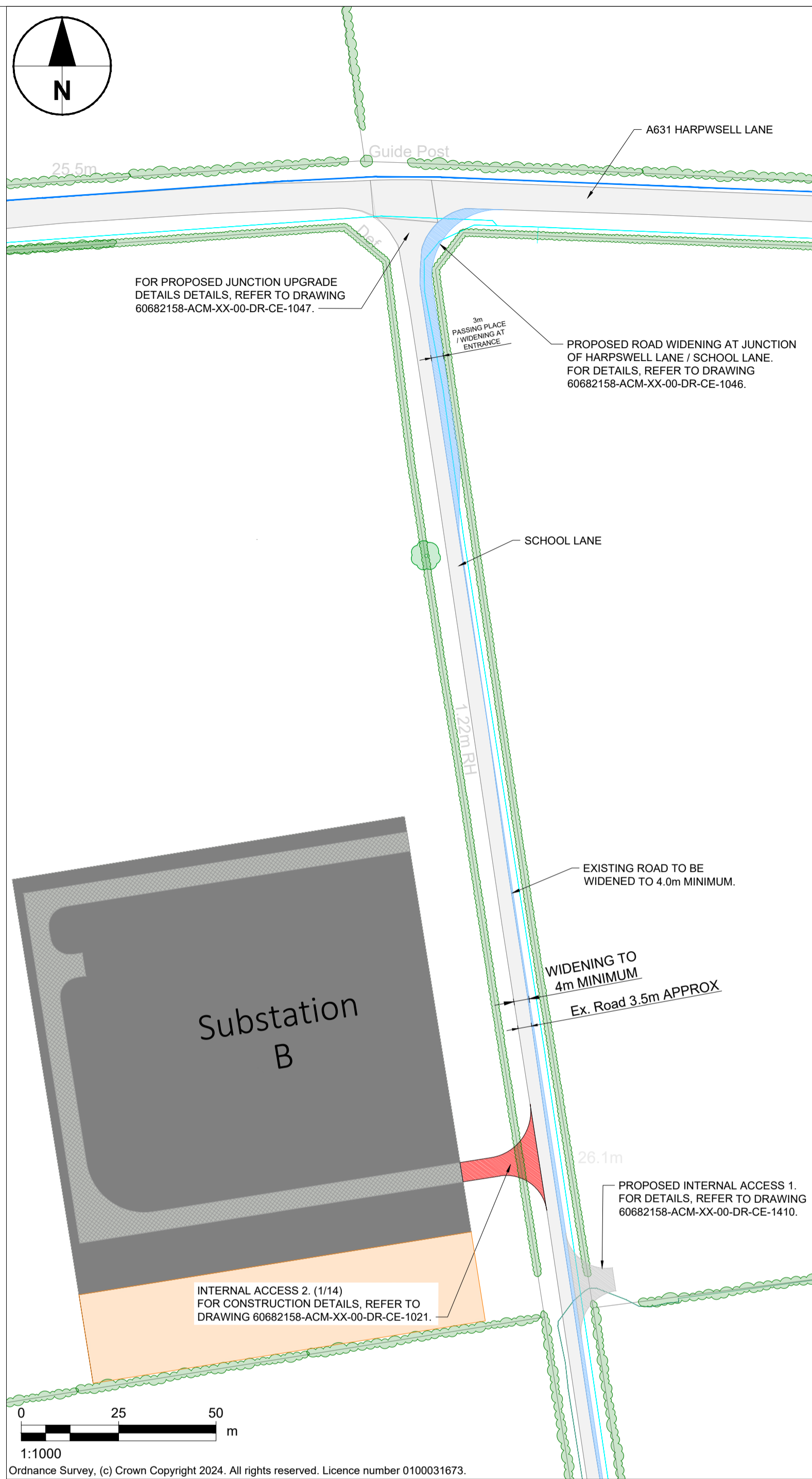

16.6m Low Loader
 Overall Length 16.633m
 Overall Width 2.600m
 Overall Body Height 3.425m
 Min Body Ground Clearance 0.350m
 Track Width 2.600m
 Lock to lock time 6.00s
 Wall to Wall Turning Radius 9.000m

INTERNAL ACCESS 2 SETTING OUT

POINTS	EASTING	NORTHING
SS001	489409.390	390542.217
SS002	489397.394	390550.956
SS003	489387.930	390549.475
SS004	489387.138	390554.412
SS005	489395.140	390555.664
SS006	489405.139	390569.376

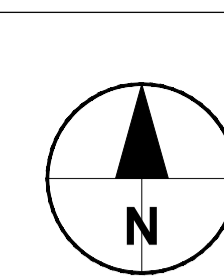
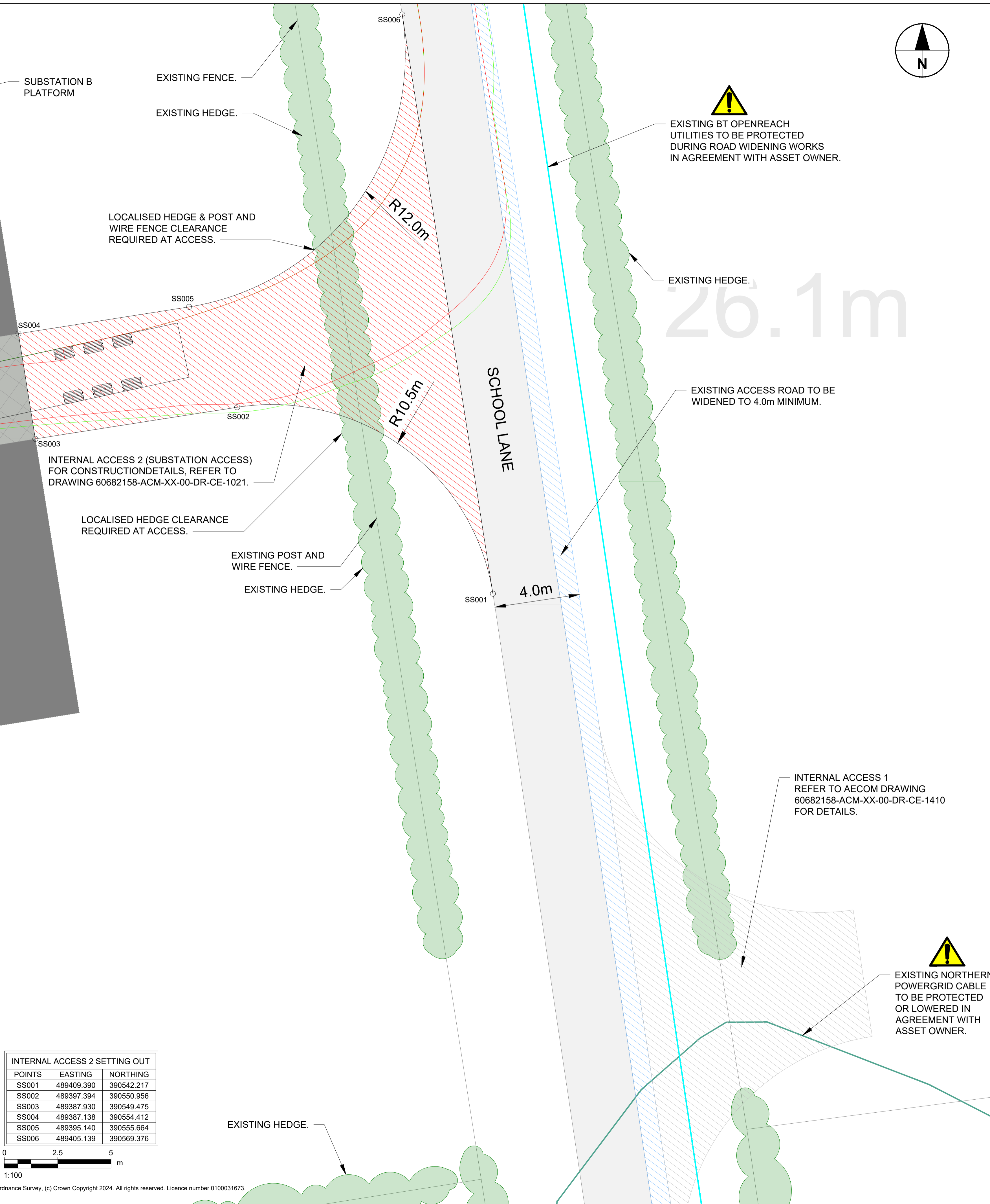
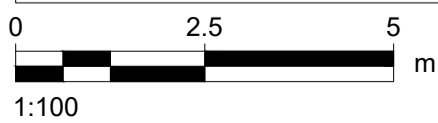

- Notes**
- DRAWING IS FOR INDICATIVE PURPOSES ONLY.
 - ALL DIMENSIONS ARE IN METRES UNLESS STATED OTHERWISE.
 - DO NOT SCALE FROM THIS DRAWING USE ONLY FIGURED DIMENSIONS.

LEGEND

- EXISTING HEDGE
- EXISTING ROAD
- PROPOSED SUBSTATION
- PROPOSED ROAD WIDENING
- PROPOSED ACCESS BELLMOUTH
- SUBSTATION INTERNAL ACCESS ROAD
- SUBSTATION B PLATFORM
- BT OPENREACH
- NORTHERN POWER
- VEHICLE WHEEL TRACK
- VEHICLE BODY OVERHANG
- AREA REQUIRED FOR PV CABLE ENTRY TO SUBSTATION, EARTHWORKS AND DRAINAGE

ISSUE/REVISION

Rev	Date	Description	Drn/Chk/Apr
B	29.03.24	INTERNAL ACCESS POINTS REMOVED AS INSTRUCTED BY CLIENT	GM/CE/CGY/AT
A	27.03.24	ADDITIONAL SUBSTATION ACCESS ADDED	GM/CE/PCGY
-	15.03.24	FIRST ISSUE	GM/CE/PCGY

NOT FOR CONSTRUCTION
FOR INFORMATION ONLY

This drawing has been prepared for the use of AECOM's client. It may not be used, modified, reproduced or relied upon by third parties, except as agreed by AECOM or as required by law. AECOM accepts no responsibility, and denies any liability, whatsoever, to any party that uses or relies on this drawing without AECOM's express written consent. Do not scale this document. All measurements must be obtained from the stated dimensions.



PROJECT
 TILLBRIDGE SOLAR PROJECT

CLIENT
 TILLBRIDGE SOLAR LIMITED

Consultant
Aecom
 1 Tanfield
 Edinburgh
 EH3 5DA
 United Kingdom
 Fax +44 (0)131 301 8699
 Tel +44 (0)131 301 8600
 www.aecom.com

Notes
 1. DRAWING IS FOR INDICATIVE PURPOSES ONLY.
 2. ALL DIMENSIONS ARE IN METRES UNLESS STATED OTHERWISE.
 3. DO NOT SCALE FROM THIS DRAWING USE ONLY FIGURED DIMENSION.

LEGEND

	- EXISTING HEDGE
	- EXISTING ROAD
	- PROPOSED ACCESS BELLMOUTH
	- OVERHEAD ELECTRICITY LINES
	- VEHICLE WHEEL TRACK
	- VEHICLE BODY OVERHANG

ISSUE/REVISION

Rev	Date	Description	Dr/Chk/Apr
-	15.03.24	FIRST ISSUE	EP/GME/CGY

NOT FOR CONSTRUCTION
FOR INFORMATION ONLY

Purpose Of Issue
 DCO SUBMISSION
Project Number
 60682158
Sheet Title
 PROPOSED
 INTERNAL ACCESS 3
Sheet Number
 60682158-ACM-XX-00-DR-CE-1414
Scale: As shown @ A1 **Rev:** .

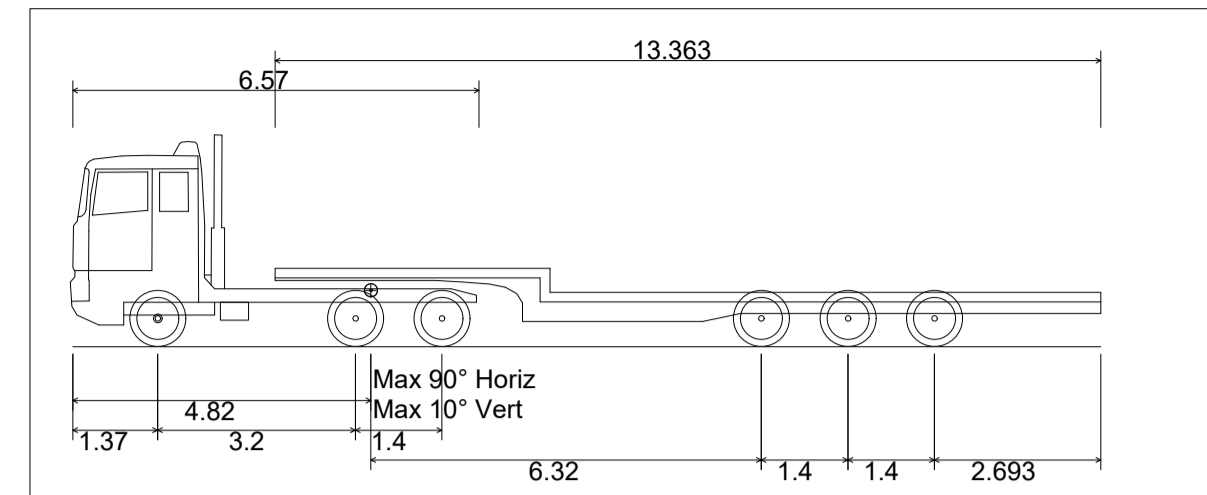

16.6m Low Loader
 Overall Length 16.633m
 Overall Width 2.600m
 Overall Body Height 3.425m
 Min Body Ground Clearance 0.350m
 Track Width 2.600m
 Lock to lock time 6.00s
 Wall to Wall Turning Radius 9.000m

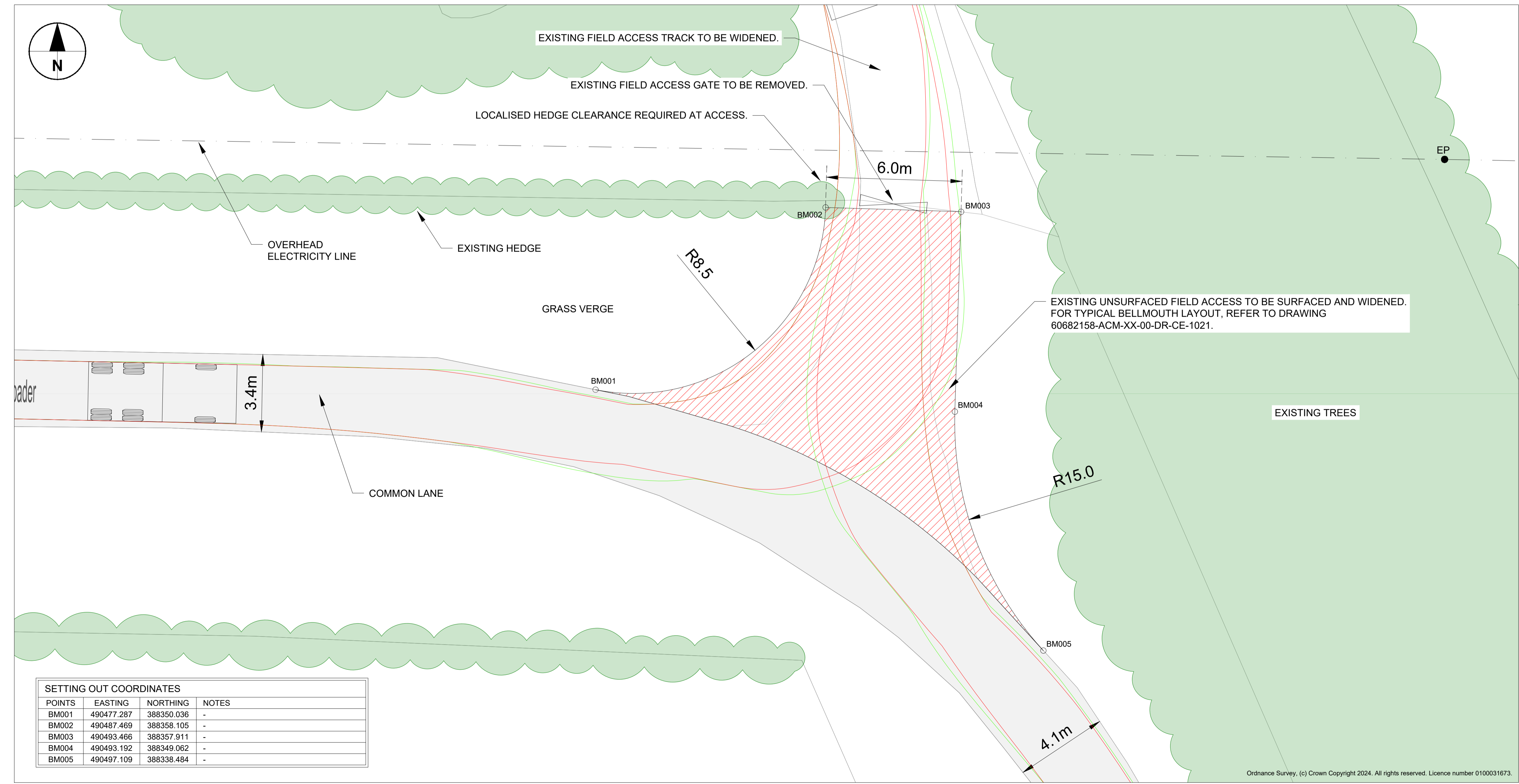
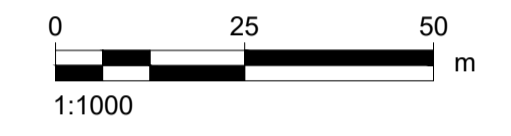

SETTING OUT COORDINATES

POINTS	EASTING	NORTHING	NOTES
BM001	490477.287	388350.036	-
BM002	490487.469	388358.105	-
BM003	490493.466	388357.911	-
BM004	490493.192	388349.062	-
BM005	490497.109	388338.484	-

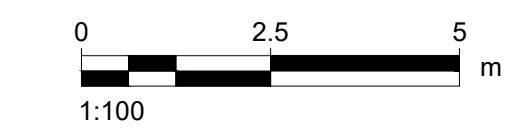

Ordnance Survey, (c) Crown Copyright 2024. All rights reserved. Licence number 0100031673.

This drawing has been prepared for the use of AECOM's client. It may not be used, modified, reproduced or relied upon by third parties, except as agreed by AECOM, or as required by law. AECOM accepts no responsibility, and denies any liability whatsoever, to any party that uses or relies on this drawing without AECOM's express written consent. Do not scale this document. All measurements must be obtained from the stated dimensions.

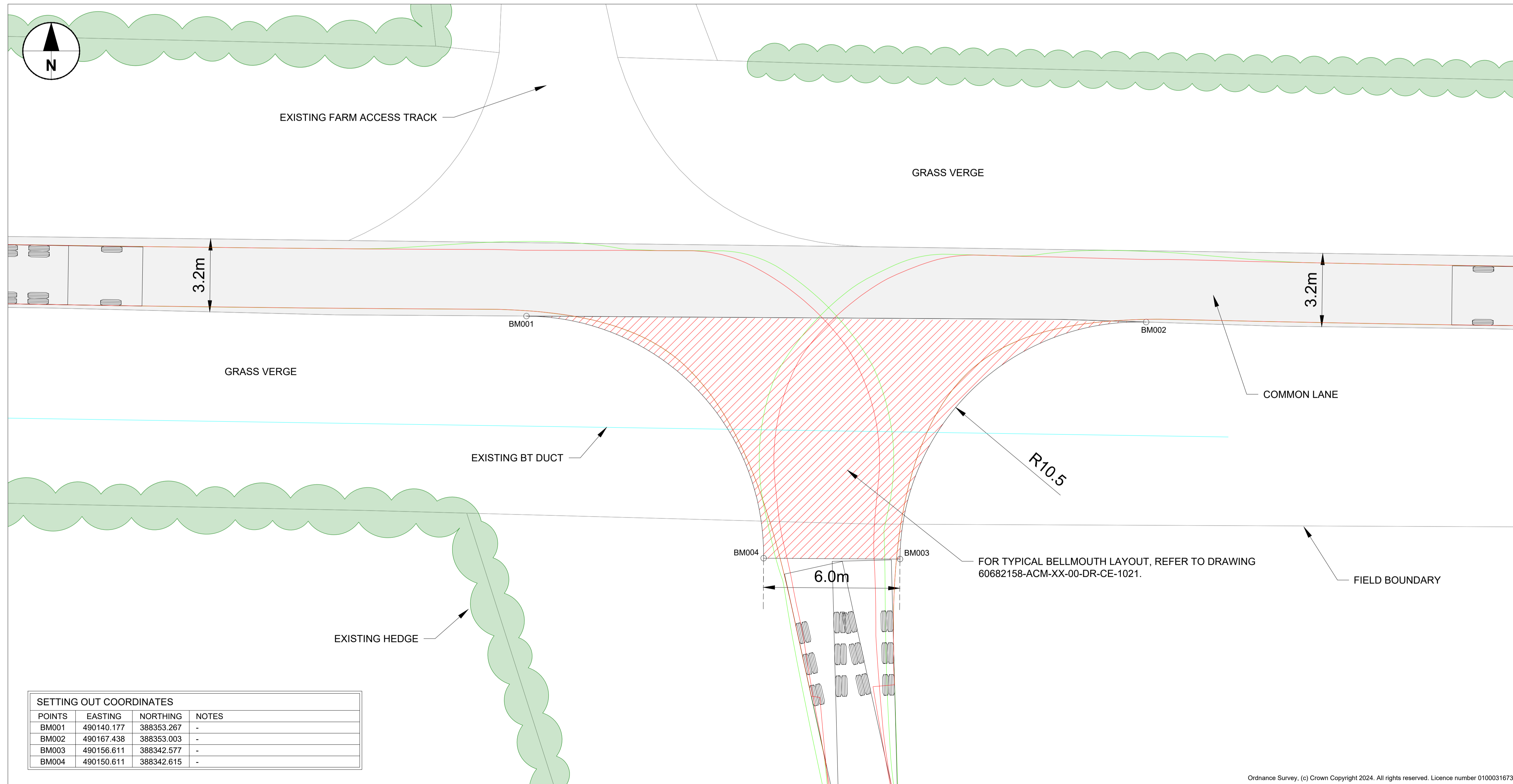
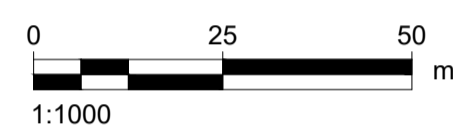
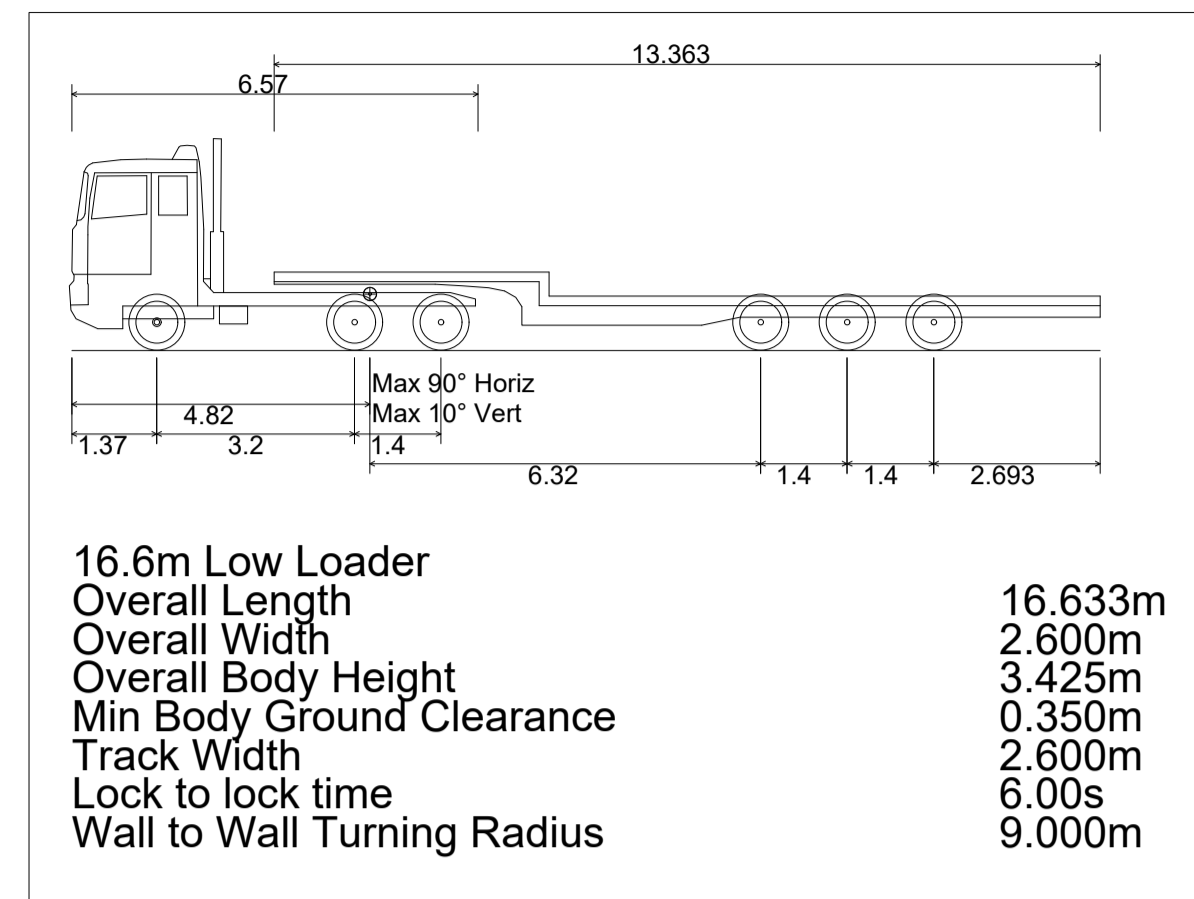

SETTING OUT COORDINATES			
POINTS	EASTING	NORTHING	NOTES
BM001	490140.177	388353.267	-
BM002	490167.438	388353.003	-
BM003	490156.611	388342.577	-
BM004	490150.611	388342.615	-

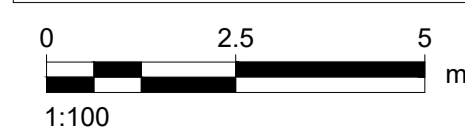

- Notes
- DRAWING IS FOR INDICATIVE PURPOSES ONLY.
 - ALL DIMENSIONS ARE IN METRES UNLESS STATED OTHERWISE.
 - DO NOT SCALE FROM THIS DRAWING USE ONLY FIGURED DIMENSION.

LEGEND

- EXISTING HEDGE
- EXISTING ROAD
- PROPOSED ACCESS BELLMOUTH
- EXISTING BT DUCT
- VEHICLE WHEEL TRACK
- VEHICLE BODY OVERHANG

ISSUE/REVISION

Rev	Date	Description	Drn/Chk/Apr
-	15.03.24	FIRST ISSUE	EP/GMcE/CGY

NOT FOR CONSTRUCTION
FOR INFORMATION ONLY

This drawing has been prepared for the use of AECOM's client. It may not be used, modified, reproduced or relied upon by third parties, except as agreed by AECOM or as required by law. AECOM accepts no responsibility, and denies any liability, whatsoever, to any party that uses or relies on this drawing without AECOM's express written consent. Do not scale this document. All measurements must be obtained from the stated dimensions.

Appendix B Figures

Figure 1 – Proposed HGV Routes - Principal Site and Cable Route Corridor

Figure 2 – Abnormal Load Routes - Principal Site and Cable Route Corridor

Figure 3 – Construction Layout

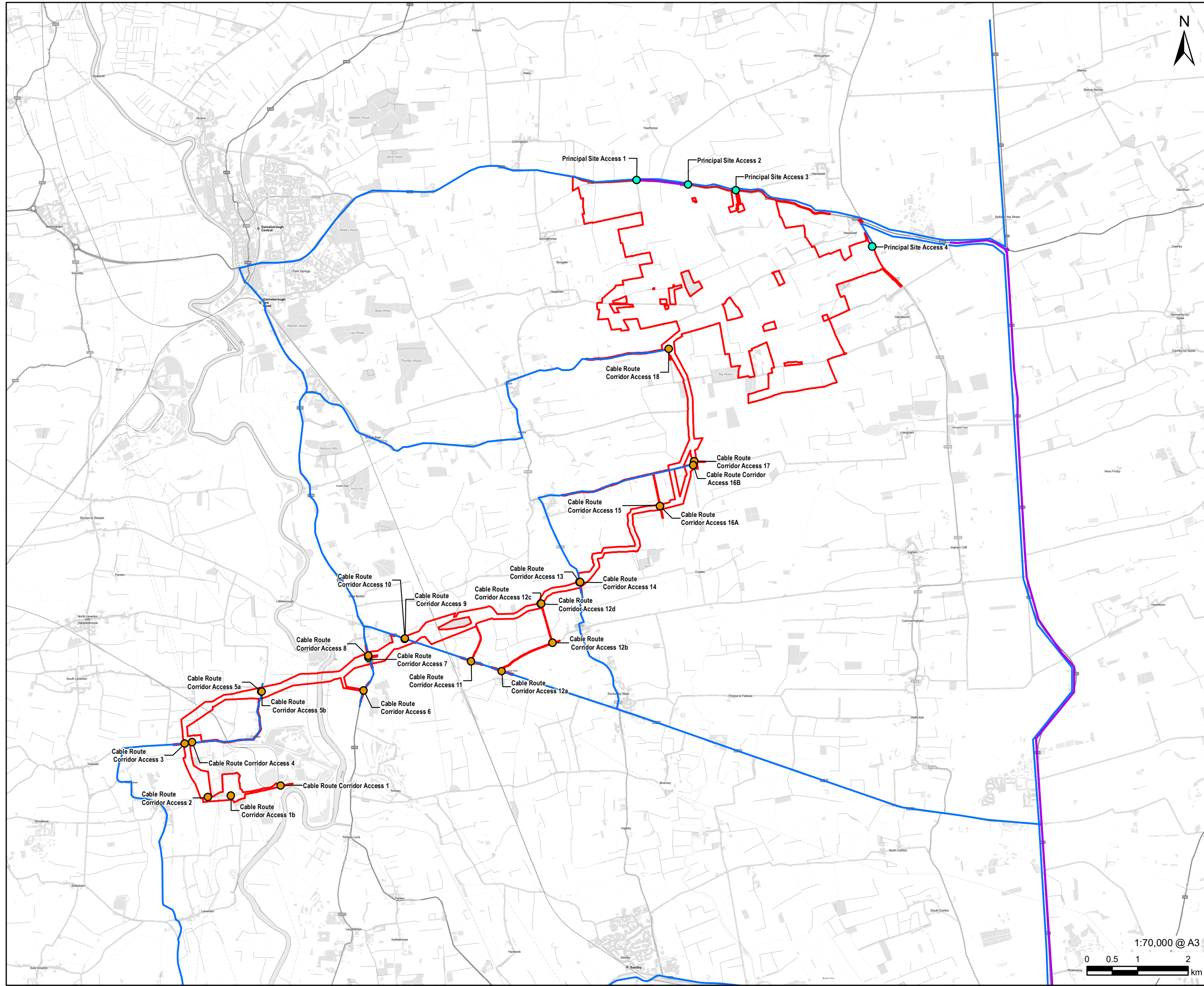

This drawing has been prepared for the use of AECOM's client. It may not be used, modified, reproduced or relied upon by third parties, except as agreed by AECOM or as required by law. AECOM accepts no responsibility, and denies any liability whatsoever, to any party that uses or relies on this drawing without AECOM's express written consent. Do not scale this document. All measurements must be obtained from the stated dimensions.

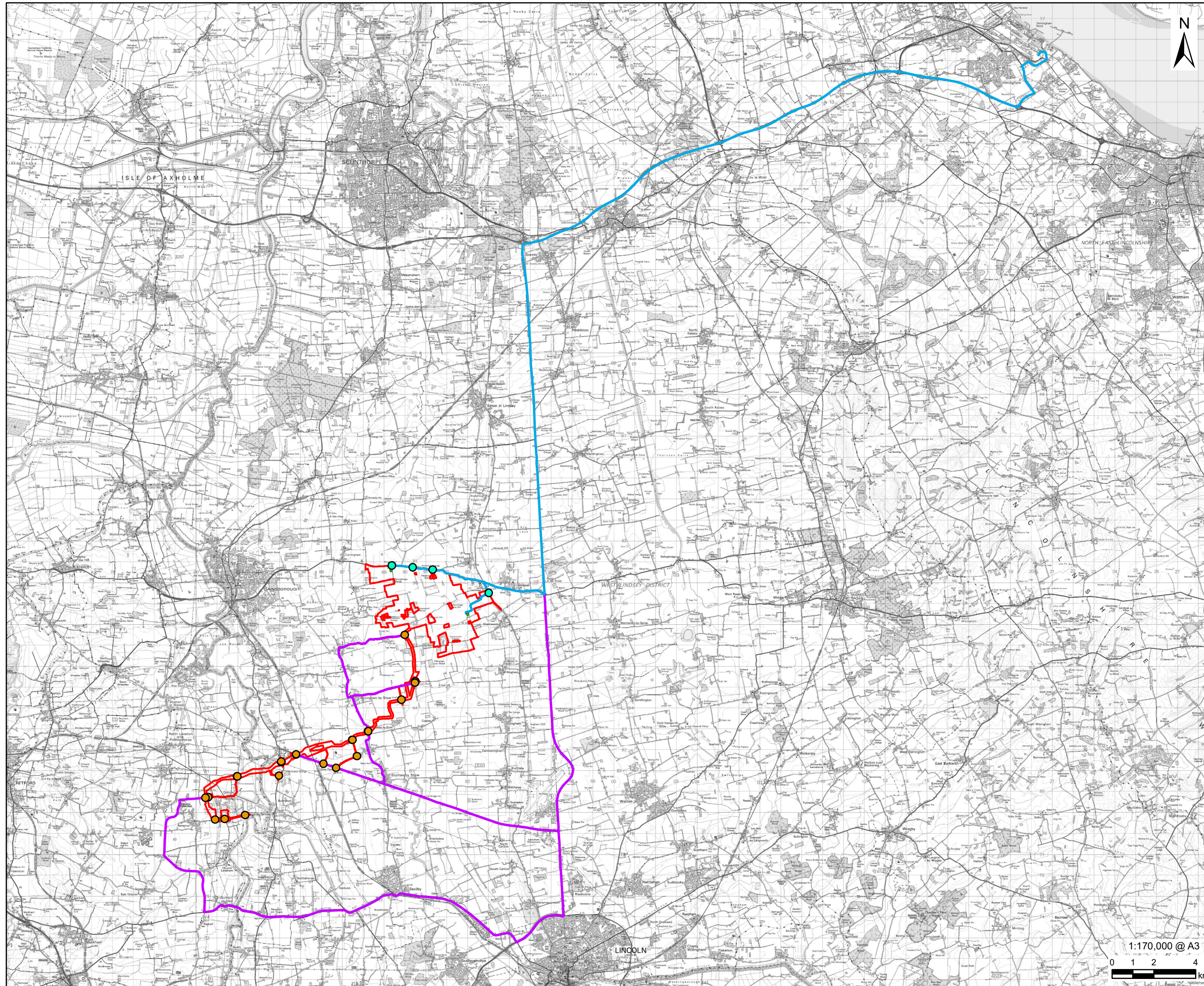

AECOM

PROJECT
Tillbridge Solar Project

CLIENT
Tillbridge Solar Ltd

CONSULTANT
Aldgate Tower
2, Leman Street
London, E1 8FA
United Kingdom
T +44-0207-645-2000

- LEGEND**
- Order limits
 - Principal Site Access
 - Cable Route Corridor Access
 - Proposed Cable Drum Delivery Route
 - Proposed AIL Route For Transformer Delivery
 - Substation

NOTES
Contains Ordnance Survey Data © Crown Copyright and database right 2024.
© Crown copyright and database rights 2024.
Ordnance Survey 0100031673.

ISSUE PURPOSE
CTMP
PROJECT NUMBER
60677969

FIGURE TITLE
Abnormal Indivisible Load Routes -
Principal Site and Cable Route Corridor

FIGURE NUMBER
Figure 2

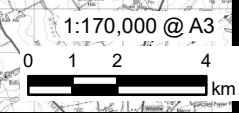

The drawing has been prepared for the use of AECOM's client. It may not be used, modified, reproduced or relied upon by third parties, except as agreed by AECOM or as required by law. AECOM accepts no responsibility, and denies any liability whatsoever, to any party that uses or relies on this drawing without AECOM's express written consent. Do not scale this document. All measurements must be obtained from the stated dimensions.

Revision: 0 Drawn: HW Checked: LL Approved: CW Date: 2024-02-29
Filename: i:\na.aecomnet.com\fs\EMEALondon-UK\LON06\Legacy\UKLON06\PPSW001-V1\DP\ELibrary\GIS_DATA\Projects\Greta III\Layout\Tillbridge Solar\CTMP_Figure3_ConstructionLayout.mxd

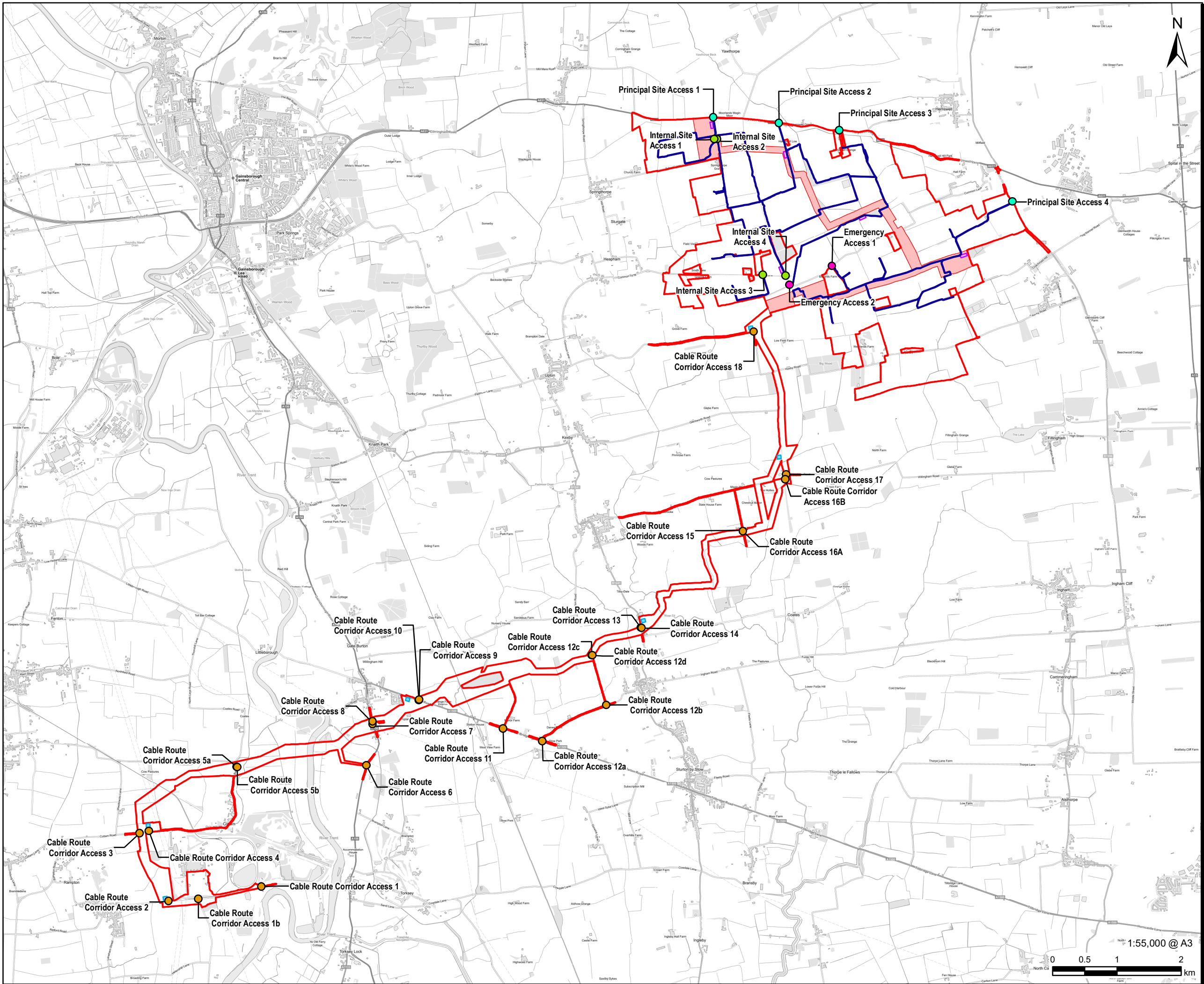

AECOM

PROJECT
Tillbridge Solar Project

CLIENT
Tillbridge Solar Ltd

CONSULTANT
Aldgate Tower
2, Leman Street
London, E1 8FA
United Kingdom
T +44-0207-645-2000

- LEGEND**
- Order limits
 - Internal Cable Corridor
 - Principal Site Access
 - Internal Site Access
 - Emergency Access
 - Cable Route Corridor Access
 - Internal Access Route
 - Construction Compound - Principal Site
 - Construction Compound - Cable Route Corridor

NOTES

Contains Ordnance Survey Data © Crown Copyright and database right 2024.
© Crown copyright and database rights 2024.
Ordnance Survey 0100031673.

ISSUE PURPOSE
CTMP

PROJECT NUMBER
60677969

FIGURE TITLE
Construction Layout

FIGURE NUMBER
Figure 3

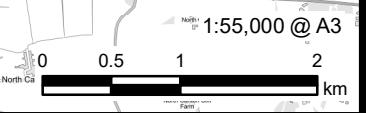

This drawing has been prepared for the use of AECOM's client. It may not be used, modified, reproduced or relied upon by third parties, except as agreed by AECOM or as required by law. AECOM accepts no responsibility, and denies any liability whatsoever, to any party that uses or relies on this drawing without AECOM's express written consent. Do not scale this document. All measurements must be obtained from the stated dimensions.